

2019
CATALOGUE



mini



Professional

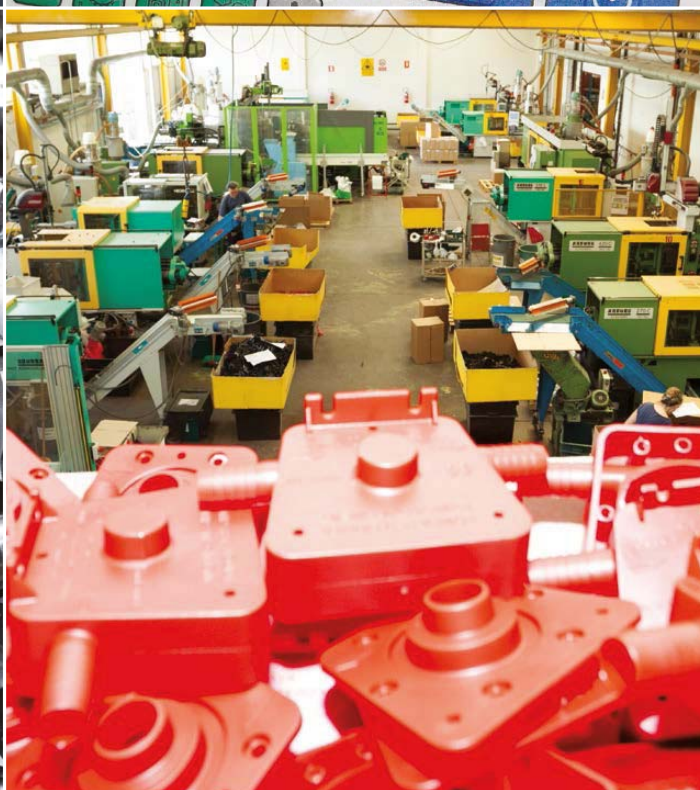
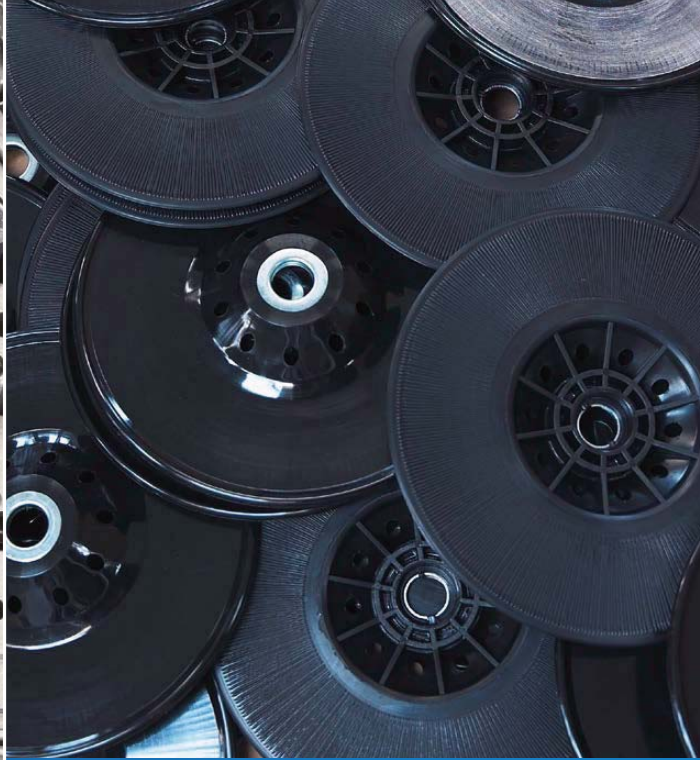

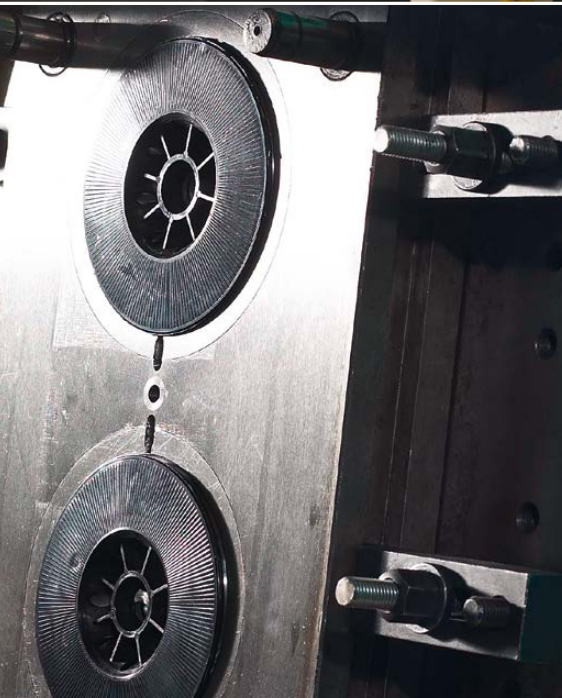
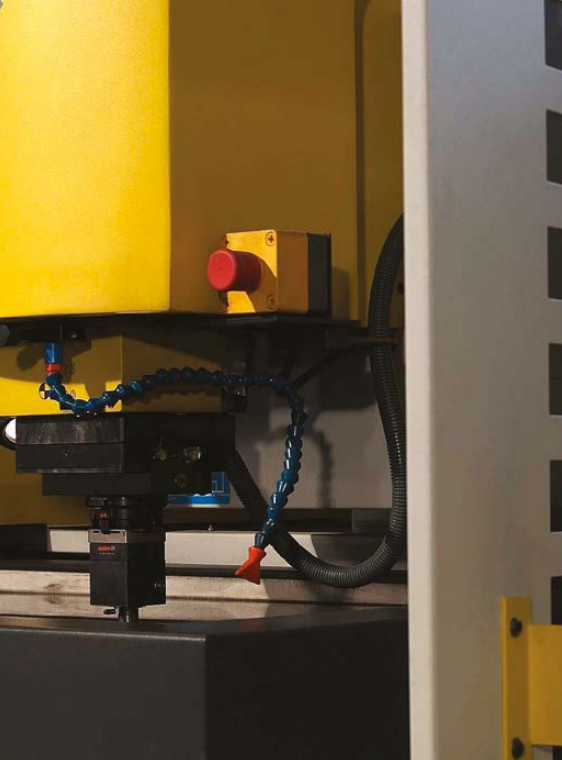

COMPETENCE, QUALITY AND SPECIALIZATION. PG'S STRENGTH.

Production, quality, range and specialization: on these strengths PG has founded its own production and organizational structure.

The reliability of the PG brand grows and strengthens throughout its history: born in the 1950s as a precision mechanical workshop specializing in the manufacture of metal parts in the early 1980s, while continuing its original business, PG's production and sales started with other products, expanding and diversifying the range of tools and drill accessories.

A long experience and an innovative and dynamic reality that always ensures precise and specific responses, have enabled PG to identify and develop new projects, select and qualify raw materials, online controls and on finished products, optimizing operating times, rational and safe management methods, scrupulous approval tests and strict controls in accordance with current European safety standards, to reach an accurate packaging study for the best lay-out at the point of sale. All this trying to reduce as much as possible the environmental impact during the manufacturing cycle, in a secure, responsible and collaborative work environment.

Identification and development of new projects, selection and qualification of raw materials, on-line and finished products controls, operational time optimization, adoption of rational and safe management methods, scrupulous approval tests and controls, rigorous according to current European safety standards, up to a careful study of the packaging for obtaining optimal displaying at the point of sale.

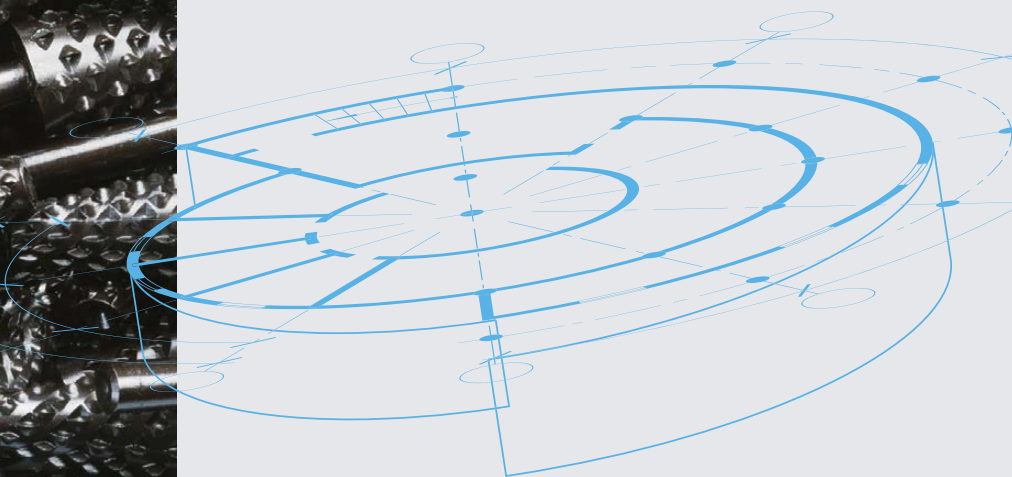
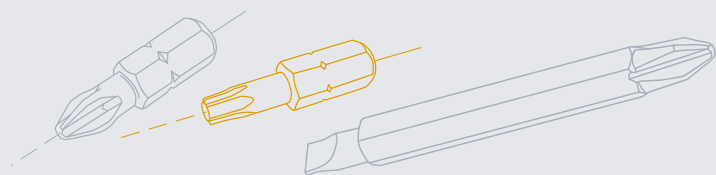



PG has developed and strengthened a capillary, efficient and flexible distribution network on the most important Italian and foreign markets, enabling customers to have a constant availability of a dialogue, an high level of service and a great relationship between price and quality.

PG range is constantly evolving and is able to provide a complete and compatible assortment with the most important brands of power tools. These are the features and benefits that make PG a guarantee and a landmark for those who want the best of production in the DIY, hardware and tools market.

The experience matured by PG, working daily with its customers, has enabled it to develop a deep knowledge of the exhibition and logistics needs of the point of sale.

A careful study of packaging, its colors and the harmonization of its formats, has been combined with the search for modular and flexible solutions for exposure. PG is able to offer a particularly effective display system, which allows to show the full range of products with a strong visual impact for customers.



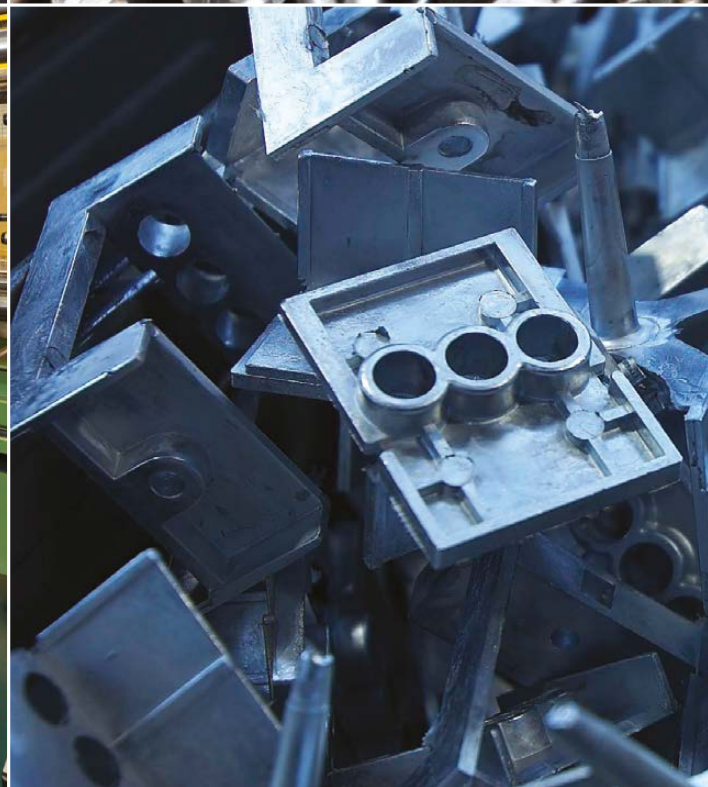
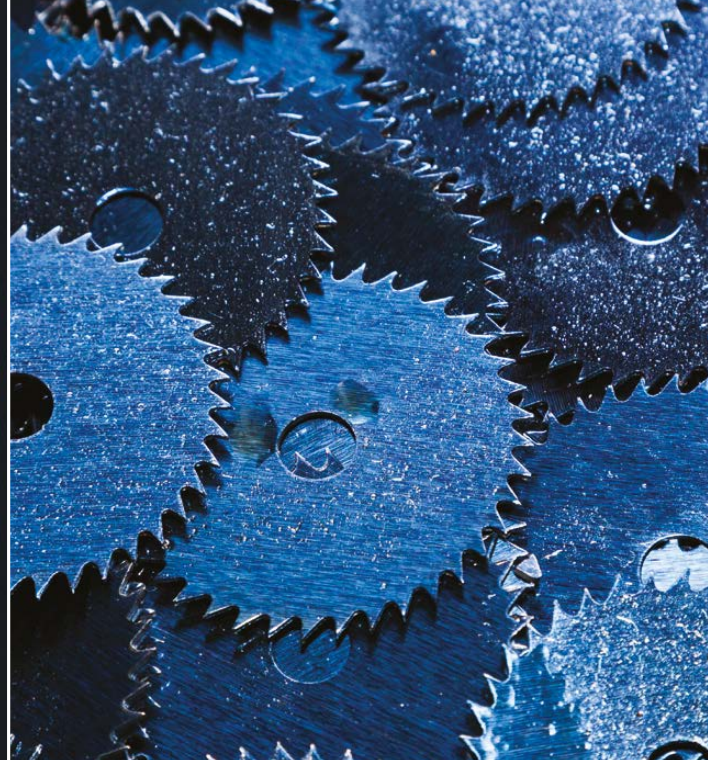
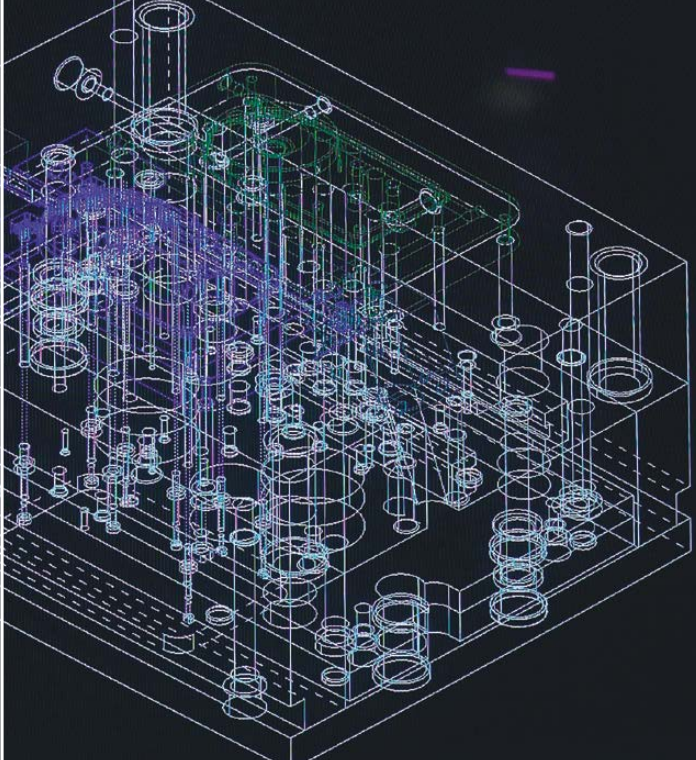



YOUR PROFESSIONAL PARTNERS

A full range of selected accessories and tools for the DIY compatible with all major brands of power tools and able to respond with confidence and reliability to all the needs in the market of DIY, hardware and tools.

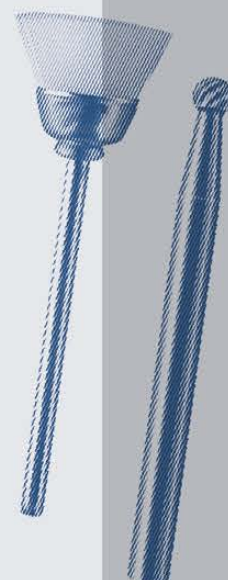

MINI SIZE, BIG PRECISION

An extensive line of mini tools and accessories for modelling, hobby, electronics and craft, which combines the precision and resistance to the force of universality, with a modern and attractive packaging for a strong visual impact.



8
PLUMBING



11
HSS TOOLS



13
UNIVERSAL ACCESSORIES



43
RASPING



45
BITS



48
BRUSHING



58
HEALTH AND SAFETY



69
WOOD JOINTING



71
JIGSAW BLADES



74
HOLE SAWS



76
CIRCULAR SAWS



94
CARVING
ENGRAVING MILLING



97
GRINDING
SHARPENING



100
SANDING



108
ACCESSORIES



114
TOOLS
TRANSFORMERS KITS

15



POLISHING

18



SANDING

30



CUTTING
GRINDING

39

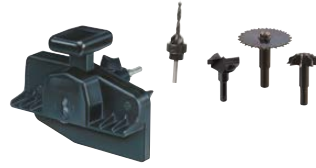

MILLING

41



FLAT DRILLS
& FORSTNER BITS

62



MIXING

63



CUTTERS

65



WOOD TOOLS

67



STAPLING

68



MEASURING

77



CHUCKS

80



TOOLS AND
ACCESSORIES

82



CLAMPING

85



DRILL STANDS

87



DRILLING

102



CLEANING POLISHING

105



CUTTING ROUGHING

107



HSS DRILL BITS

TAP RE-SEATING TOOL

For taps with external thread



103	with conical part \varnothing 28 x 25 mm and cutter 1/2	<input type="checkbox"/> 10	103006
212	with conical part \varnothing 28 x 25 mm 2 cutters 3/8 - 1/2 and 2 washers	<input checked="" type="checkbox"/> 10	212005
201	with conical part \varnothing 40 x 27 mm 4 cutters 3/8 - 1/2 - 3/4 - 1" 2 conical spare parts \varnothing 27 - 32 mm	<input type="checkbox"/> 1	201009
203	with conical part \varnothing 32 x 27 mm 2 cutters 1/2 - 3/4 and 2 washers	<input checked="" type="checkbox"/> 1	203003
205	with conical part \varnothing 40 x 27 mm 4 cutters 3/8 - 1/2 - 3/4 - 1"	<input checked="" type="checkbox"/> 1	205007
204	with conical part \varnothing 65 x 65 mm 4 cutters 1" 1/8 - 1" 1/4 - 1" 1/2 - 2"	<input type="checkbox"/> 1	204147
207	with conical part \varnothing 40 x 27 mm 4 cutters 3/8 - 1/2 - 3/4 - 1"	<input type="checkbox"/> 1	207001
208	with double conical part \varnothing 30 x 60 mm 6 cutters \varnothing 10 - 12 - 13 - 14 - 15 - 16 mm	<input type="checkbox"/> 1	208008
209	with double conical part \varnothing 25 x 46 mm 3 cutters \varnothing 13 - 15 - 16 mm	<input type="checkbox"/> 1	209005

TAP RE-SEATING TOOL

For taps with external-internal thread

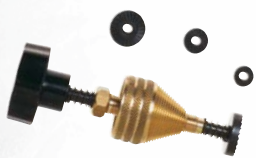

202	with conical part \varnothing 42 x 42 mm 4 cutters 3/8 - 1/2 - 3/4 - 1"	<input type="checkbox"/> 1	202006
------------	---	----------------------------	--------

TAP RE-SEATING TOOL

For taps with external-cylindrical thread

210	with cylindrical part \varnothing 33 x 38 mm 4 cutters 3/8 - 1/2 - 3/4 - 1"	1	210001
213	with cylindrical part \varnothing 28 x 24 mm 2 cutters 3/8 - 1/2 and 2 washers	10	213002

**CUTTER**

11.010	\varnothing 10 mm	10	110103
11.012	\varnothing 12 mm	10	110127
11.014	\varnothing 14 mm - 3/8	10	110141
11.017	\varnothing 17 mm - 1/2	10	110172
11.024	\varnothing 24 mm - 3/4	10	110240
11.028	\varnothing 28 mm - 1"	10	110288
11.034	\varnothing 34 mm - 1" 1/8	5	110349
11.038	\varnothing 38 mm - 1" 1/4	5	110387
11.043	\varnothing 43 mm - 1" 1/2	5	110431
11.055	\varnothing 55 mm - 2"	5	110554

**PIPE FLARING KIT** complete with pipe clamp and flaring tool

300.00	for pipes \varnothing 10 - 12 - 14 - 16 mm	1	300009
304.00	for pipes \varnothing 10 - 12 - 14 - 16 - 18 - 20 - 22 mm	1	304007

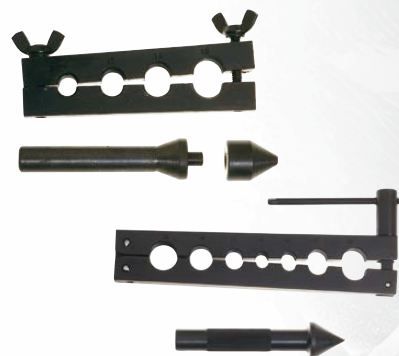

UNIVERSAL WRENCH



305.00	can be used on left-hand or right-hand nuts	5	305004
---------------	---	---	--------

PIPE CUTTER

For pipes of copper, brass, plastic, iron



316.00	from 1/8 to 5/8 - 16 mm	5	316000
328.00	from 1/8 to 1" 1/8 - 28 mm	5	328003
332.00	from 1/8 to 1" 1/4 - 32 mm	5	332000

TELESCOPIC PIPE CUTTER

For pipes of copper, brass, plastic, iron



332.35	from 1/8 to 1" 3/8 - 35 mm	5	332352
334.00	from 1/4 to 1" 5/8 - 42 mm supplied with 2 spare blades and extractable reamer	1	334004

SPARE CUTTING BLADE



333.00	universal	10	333007
334.20	for art. 334.00	10	334202

HSS ENLARGING CUTTER for steel

800.00	from \varnothing 3 mm to \varnothing 14 mm - shank \varnothing 6 mm - 550 RPM	1	800004
805.00	from \varnothing 6 mm to \varnothing 20 mm - shank \varnothing 8 mm - 500 RPM	1	805009
810.00	from \varnothing 8 mm to \varnothing 30 mm - shank \varnothing 10 mm - 400 RPM	1	810003
820.00	from \varnothing 20 mm to \varnothing 40 mm - shank \varnothing 10 mm - 300 RPM	1	820002
825.00	from \varnothing 20 mm to \varnothing 50 mm - shank \varnothing 10 mm - 200 RPM	1	825007

**HSS STEP DRILL BIT** for steel

825.50	from \varnothing 4 mm to \varnothing 12 mm - shank \varnothing 6 mm - 800 RPM	1	825502
826.00	from \varnothing 4 mm to \varnothing 20 mm - shank \varnothing 8 mm - 500 RPM	1	826004
828.00	from \varnothing 4 mm to \varnothing 30 mm - shank \varnothing 10 mm - 400 RPM	1	828008
829.00	from \varnothing 3,5 mm to \varnothing 40 mm - shank \varnothing 10 mm - 300 RPM	1	829005



HSS ENLARGING CUTTER for steel

835.00	from \varnothing 0 mm to \varnothing 25 mm - shank \varnothing 8 mm - 500 RPM	5	835006
835.50	from \varnothing 6 mm to \varnothing 32 mm - shank \varnothing 10 mm - 500 RPM	1	835501
835.60	from \varnothing 6 mm to \varnothing 45 mm - shank \varnothing 10 mm - 300 RPM	1	835600

HSS COUNTERSINK for steel - shank \varnothing 8 mm

840.00	\varnothing 12 mm - 500 RPM	5	840000
845.00	\varnothing 16 mm - 500 RPM	5	845005
850.00	\varnothing 20 mm - 500 RPM	5	850009

ADJUSTABLE HOLE CUTTER for cutting laminates, metal

214.00	with \varnothing 6 mm HSS drill - for holes from 20 mm to 123 mm 250 RPM	5	214009
215.00	with \varnothing 10 mm HSS drill - for holes from 25 mm to 217 mm 250 RPM	5	215006
216.00	with \varnothing 4 mm HSS drill - for holes from 27 mm to 104 mm 250 RPM	5	216003

HSS CUTTING TOOL

214.10	\square 5 mm for art. 214.00	5	214108
215.10	\square 6 mm for art. 215.00	5	215105
216.10	\varnothing 5 mm for art. 216.00	5	216102

ref.

description

pack
q.tyEAN13
8011017**UNIVERSAL
ACCESSORIES****CONE-SHAPED STEEL RING NUT** - collar \varnothing 22 mm

218.00	14 MA	<input checked="" type="checkbox"/>	218007
220.00	8 MA	<input type="checkbox"/>	220000
220.50	10 MA - collar \varnothing 16 mm	<input type="checkbox"/>	220505
221.00	10 MA	<input type="checkbox"/>	221007
222.00	14 MA	<input type="checkbox"/>	222004
223.00	5/8"	<input type="checkbox"/>	223001

**FLAT STEEL RING NUT** - collar \varnothing 22 mm

219.00	14 MA	<input checked="" type="checkbox"/>	219004
224.00	8 MA	<input type="checkbox"/>	224008
225.00	10 MA	<input type="checkbox"/>	225005
226.00	14 MA	<input type="checkbox"/>	226002
227.00	5/8"	<input type="checkbox"/>	227009

**STEEL UNIVERSAL WRENCH** for ring nuts

228.00	35 mm	<input checked="" type="checkbox"/>	228006
229.00	35 mm	<input type="checkbox"/>	229003
230.00	20/35 mm - adjustable	<input checked="" type="checkbox"/>	230009
231.00	20/35 mm - adjustable	<input type="checkbox"/>	231006

**STEEL BACK NUT**

250.00	for discs \varnothing 115 mm \varnothing 41 mm - thickness 7,5 mm - hole \varnothing 14 mm	<input type="checkbox"/>	250007
253.00	for discs \varnothing 230 mm \varnothing 41 mm - thickness 9 mm - hole \varnothing 14 mm	<input type="checkbox"/>	253008

**ARBOR**

335.00	10,0 x 6 mm	<input checked="" type="checkbox"/>	335001
336.00	12,8 x 8 mm	<input type="checkbox"/>	336008
337.00	22,2 x 8 mm	<input type="checkbox"/>	337005

 PG pack neutral pack

RUBBER BACKING PAD

338.00	Ø 125 mm - gambo Ø 6 mm	10	338002
---------------	-------------------------	----	--------

338.05	Ø 180 mm - bore Ø 16 mm	10	338057
---------------	-------------------------	----	--------

338.08	Ø 180 mm - bore Ø 16 mm	10	338088
---------------	-------------------------	----	--------

NYLON BACKING PAD

338.10	Ø 100 mm - bore Ø 10 mm	10	338101
---------------	-------------------------	----	--------

338.20	Ø 115 mm - bore Ø 14 mm	10	338200
---------------	-------------------------	----	--------

338.22	Ø 178 mm - bore Ø 14 mm	10	338224
---------------	-------------------------	----	--------

338.25	Ø 100 mm - bore Ø 10 mm	10	338255
---------------	-------------------------	----	--------

338.30	Ø 115 mm - bore Ø 10 mm	10	338309
---------------	-------------------------	----	--------

338.35	Ø 115 mm - bore Ø 14 mm	10	338354
---------------	-------------------------	----	--------

338.40	Ø 115 mm - bore Ø 16 mm	10	338408
---------------	-------------------------	----	--------

338.45	Ø 125 mm - bore Ø 14 mm	10	338453
---------------	-------------------------	----	--------

338.50	Ø 125 mm - bore Ø 16 mm	10	338507
---------------	-------------------------	----	--------

338.55	Ø 150 mm - bore Ø 14 mm	10	338552
---------------	-------------------------	----	--------

338.60	Ø 150 mm - bore Ø 16 mm	10	338606
---------------	-------------------------	----	--------

338.65	Ø 178 mm - bore Ø 14 mm	10	338651
---------------	-------------------------	----	--------

338.70	Ø 178 mm - bore Ø 16 mm	10	338705
---------------	-------------------------	----	--------

338.75	Ø 178 mm - bore Ø 14 mm - white color	10	338750
---------------	---------------------------------------	----	--------

VELCRO BACKING PAD

shank Ø 10 mm - bore M14

338.80	Ø 115 mm	5	338804
---------------	----------	---	--------

338.82	Ø 125 mm	5	338828
---------------	----------	---	--------

338.85	Ø 150 mm	5	338859
---------------	----------	---	--------



ref.

description

pack
q.tyEAN13
8011017**POLISHING****BUFFING BONNET WITH TIGHTENING**

339.00	ø 140 mm	10	339009
339.20	ø 190 mm	10	339207

LAMBSWOOL BONNET VELCRO FITTING

339.22	ø 115 mm	10	339221
339.23	ø 125 mm	10	339238
339.24	ø 160 mm	10	339245

FELT BUFFING WHEEL

339.25	ø 80 x 10 mm - hole ø 13 mm	10	339252
339.27	ø 125 x 15 mm - hole ø 16 mm	10	339276
339.28	ø 150 x 20 mm - hole ø 16 mm	10	339283

FELT POLISHING DISC VELCRO FITTING

339.26	ø 125 mm	10	339269
---------------	----------	----	--------

FELT POLISHING PAD VELCRO FITTING for Delta grinder

339.29	93 mm	10	339290
---------------	-------	----	--------

COTTON BUFFING WHEEL

339.30	ø 80 mm - shank ø 6 mm	10	339306
339.35	ø 100 mm - hole ø 20/13 mm	10	339351
339.40	ø 120 mm - hole ø 20/16 mm	10	339405
339.45	ø 150 mm - hole ø 20/16 mm	10	339450

 PG pack neutral pack



COTTON AND SISAL POLISHING WHEEL

339.46	∅ 80 mm - shank ∅ 6 mm	10	339467
339.49	∅ 150 mm - hole ∅ 20/16 mm	10	339498



POLISHING CUSHION

339.50	∅ 125 mm - shank ∅ 6 mm	1	339504
339.60	∅ 175 mm - bore M14	1	339603



POLISHING CUSHION PAD

339.62	∅ 125 mm	1	339627
339.64	∅ 175 mm	1	339641



POLISHING CUSHION PAD VELCRO FITTING

339.66	∅ 115 mm	1	339665
339.67	∅ 125 mm	1	339672
339.68	∅ 160 mm	1	339689

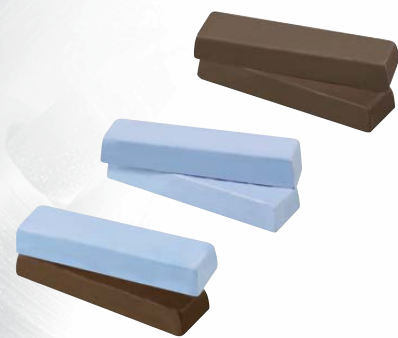

POLISHING PASTE

359.36	2 pre-polishing pastes	10	359366
359.37	2 polishing pastes	10	359373
359.38	2 assorted polishing pastes	10	359380

ref.

description

pack
q.tyEAN13
8011017**POLISHING****FLAP FINISHING WHEEL OF ABRASIVE CLOTH**Fine sanding - grain **150**

359.40	∅ 50 x 25 mm - shank ∅ 6 mm	5	359403
359.42	∅ 75 x 45 mm - shank ∅ 6 mm	5	359427
359.44	∅ 100 x 50 mm - shank ∅ 6 mm	5	359441
359.70	∅ 150 x 25 mm - hole ∅ 32/20 mm	5	359700

**FLAP FINISHING WHEEL OF ABRASIVE AND EMERY CLOTH**Medium sanding - grain **150**

359.46	∅ 50 x 25 mm - shank ∅ 6 mm	5	359465
359.48	∅ 75 x 45 mm - shank ∅ 6 mm	5	359489
359.50	∅ 100 x 50 mm - shank ∅ 6 mm	5	359502
359.72	∅ 150 x 25 mm - hole ∅ 32/20 mm	5	359724

**NYLON FIBER DISC**

359.82	flat ∅ 100 mm - hole ∅ 13 mm	5	359823
359.86	depressed centre ∅ 115 mm - hole ∅ 22 mm	5	359861



PG pack

neutral pack

SMOOTHING BLOCK for hand sanding



339.70	125 x 70 mm	10	339702
339.72	125 x 70 mm suitable also for abrasive discs velcro fitting	5	339726
339.73	Ø 125 mm for abrasive discs velcro fitting for convex surfaces	5	339733
339.74	Ø 125 mm for abrasive discs velcro fitting for corner works	5	339740
339.75	Ø 125 mm for abrasive discs velcro fitting	5	339757
339.76	Ø 150 mm for abrasive discs velcro fitting for corner works	5	339764
339.79	MINI - for abrasive sheets velcro fitting	5	339795

VELCRO ABRASIVE SHEETS for MINI smoothing block



348.25	10 sheets coarse grain for art. 339.79	5	348254
348.26	10 sheets medium grain for art. 339.79	5	348261
348.27	10 sheets fine grain for art. 339.79	5	348278

SANDING SPONGE



339.80	1 sanding sponge - double grain 60/100 - for wood and metal	10	339801
339.81	250 sanding sponges - double grain 60/100 - for wood and metal	1	339818
339.85	24 sanding sponges - double grain 60/100 - for wood and metal - in display box	1	339856
339.90	2 auto-sponges - grain 100 - for metal	10	339900
339.91	250 auto-sponges - grain 100 - for metal	1	339917

ref.

description

pack
q.tyEAN13
8011017**SANDING****PAPER SANDING DISCS - ø 125 mm - coating support 160 g**

340.00	15 discs grain 50	<input checked="" type="checkbox"/>	340005
341.00	15 discs grain 80	<input checked="" type="checkbox"/>	341002
342.00	15 discs grain 120	<input checked="" type="checkbox"/>	342009
343.00	15 discs assorted grades	<input checked="" type="checkbox"/>	343006

PAPER SANDING DISCS - ø 125 mm - coating support 230 g

344.00	5 discs grain 50	<input checked="" type="checkbox"/>	344003
344.10	5 discs grain 80	<input checked="" type="checkbox"/>	344102
344.20	5 discs grain 120	<input checked="" type="checkbox"/>	344201
344.30	5 discs assorted grades	<input checked="" type="checkbox"/>	344300

EMERY CLOTH DISCS - ø 125 mm

350.00	6 discs grain 40	<input checked="" type="checkbox"/>	350004
351.00	6 discs grain 80	<input checked="" type="checkbox"/>	351001
352.00	6 discs grain 150	<input checked="" type="checkbox"/>	352008
353.00	6 discs assorted grades	<input checked="" type="checkbox"/>	353005

EMERY CLOTH AND PAPER SANDING DISCS - ø 125 mm

355.00	4 emery cloth discs + 8 paper sanding discs	<input checked="" type="checkbox"/>	355009
---------------	--	-------------------------------------	--------

FIBRE BACKED DISCS - ø 115 mm

347.00	6 discs grain 36	<input checked="" type="checkbox"/>	347004
347.10	6 discs grain 60	<input checked="" type="checkbox"/>	347103
347.20	6 discs grain 100	<input checked="" type="checkbox"/>	347202

FIBRE BACKED DISCS - ø 180 mm

348.00	6 discs grain 36	<input checked="" type="checkbox"/>	348001
348.10	6 discs grain 60	<input checked="" type="checkbox"/>	348100
348.20	6 discs grain 100	<input checked="" type="checkbox"/>	348209

 PG pack neutral pack

VELCRO ABRASIVE SHEETS with dust extraction holes - **93** mm

348.30	5 sheets grain 40	<input checked="" type="checkbox"/>	348308
348.31	25 sheets grain 40	<input type="checkbox"/>	348315
348.35	5 sheets grain 60	<input checked="" type="checkbox"/>	348353
348.36	25 sheets grain 60	<input type="checkbox"/>	348360
348.40	5 sheets grain 80	<input checked="" type="checkbox"/>	348407
348.41	25 sheets grain 80	<input type="checkbox"/>	348414
348.45	5 sheets grain 120	<input checked="" type="checkbox"/>	348452
348.46	25 sheets grain 120	<input type="checkbox"/>	348469
348.50	5 sheets grain 240	<input checked="" type="checkbox"/>	348506
348.51	25 sheets grain 240	<input type="checkbox"/>	348513
348.56	25 sheets assorted grades	<input type="checkbox"/>	348568

VELCRO ABRASIVE DISCS - \varnothing **115** mm

349.00	10 sheets grain 40	<input checked="" type="checkbox"/>	349008
349.01	25 sheets grain 40	<input type="checkbox"/>	349015
349.10	10 sheets grain 120	<input checked="" type="checkbox"/>	349107
349.11	25 sheets grain 120	<input type="checkbox"/>	349114
349.20	10 sheets grain 240	<input checked="" type="checkbox"/>	349206
349.21	25 sheets grain 240	<input type="checkbox"/>	349213
349.30	10 sheets assorted grades	<input checked="" type="checkbox"/>	349305
349.31	25 sheets assorted grades	<input type="checkbox"/>	349312

VELCRO ABRASIVE DISCS - \varnothing **125** mm

349.55	10 sheets grain 40	<input checked="" type="checkbox"/>	349558
349.56	25 sheets grain 40	<input type="checkbox"/>	349565
349.60	10 sheets grain 120	<input checked="" type="checkbox"/>	349602
349.61	25 sheets grain 120	<input type="checkbox"/>	349619
349.65	10 sheets grain 240	<input checked="" type="checkbox"/>	349657
349.66	25 sheets grain 240	<input type="checkbox"/>	349664
349.70	10 sheets assorted grades	<input checked="" type="checkbox"/>	349701
349.71	25 sheets assorted grades	<input type="checkbox"/>	349718

VELCRO ABRASIVE DISCS with dust extraction holes - ø **115** mm

349.33	10 discs grain 40	<input checked="" type="checkbox"/>	10	349336
349.34	25 discs grain 40	<input type="checkbox"/>	1	349343
349.35	10 discs grain 80	<input checked="" type="checkbox"/>	10	349350
349.36	25 discs grain 80	<input type="checkbox"/>	1	349367
349.40	10 discs grain 120	<input checked="" type="checkbox"/>	10	349404
349.41	25 discs grain 120	<input type="checkbox"/>	1	349411
349.45	10 discs grain 240	<input checked="" type="checkbox"/>	10	349459
349.46	25 discs grain 240	<input type="checkbox"/>	1	349466
349.50	10 sheets assorted grades	<input checked="" type="checkbox"/>	10	349503
349.51	25 sheets assorted grades	<input type="checkbox"/>	1	349510

**VELCRO ABRASIVE DISCS** with dust extraction holes - ø **125** mm

349.73	10 discs grain 40	<input checked="" type="checkbox"/>	10	349732
349.74	25 discs grain 40	<input type="checkbox"/>	1	349749
349.75	10 discs grain 80	<input checked="" type="checkbox"/>	10	349756
349.76	25 discs grain 80	<input type="checkbox"/>	1	349763
349.80	10 discs grain 120	<input checked="" type="checkbox"/>	10	349800
349.81	25 discs grain 120	<input type="checkbox"/>	1	349817
349.85	10 discs grain 240	<input checked="" type="checkbox"/>	10	349855
349.86	25 discs grain 240	<input type="checkbox"/>	1	349862
349.90	10 sheets assorted grades	<input checked="" type="checkbox"/>	10	349909
349.91	25 sheets assorted grades	<input type="checkbox"/>	1	349916

**VELCRO ABRASIVE DISCS** with dust extraction holes - ø **150** mm

349.95	10 discs grain 40	<input checked="" type="checkbox"/>	10	349954
349.96	10 discs grain 80	<input checked="" type="checkbox"/>	10	349961
349.97	10 discs grain 120	<input checked="" type="checkbox"/>	10	349978
349.98	10 discs grain 240	<input checked="" type="checkbox"/>	10	349985
349.99	10 sheets assorted grades	<input checked="" type="checkbox"/>	10	349992



FINISHING PAPER SHEETS - 230 x 280 mm

355.60	6 sheets grain 60	<input type="checkbox"/>	355603
355.62	6 sheets grain 100	<input type="checkbox"/>	355627
355.64	6 sheets grain 150	<input type="checkbox"/>	355641
355.66	6 sheets assorted grades	<input type="checkbox"/>	355665
FC.01	1 sheet grain 40	<input type="checkbox"/>	083346
FC.03	1 sheet grain 60	<input type="checkbox"/>	083353
FC.04	1 sheet grain 80	<input type="checkbox"/>	083360
FC.05	1 sheet grain 100	<input type="checkbox"/>	083377
FC.06	1 sheet grain 120	<input type="checkbox"/>	083384
FC.07	1 sheet grain 150	<input type="checkbox"/>	083391
FC.08	1 sheet grain 180	<input type="checkbox"/>	083407

WET + DRY PAPER SHEETS - 230 x 280 mm

355.70	6 sheets grain 180	<input type="checkbox"/>	355702
355.72	6 sheets grain 320	<input type="checkbox"/>	355726
355.74	6 sheets grain 600	<input type="checkbox"/>	355740
355.76	6 sheets assorted grades	<input type="checkbox"/>	355764
WSC.01	1 sheet grain 100	<input type="checkbox"/>	085982
WSC.02	1 sheet grain 120	<input type="checkbox"/>	085999
WSC.03	1 sheet grain 150	<input type="checkbox"/>	086002
WSC.04	1 sheet grain 180	<input type="checkbox"/>	086019
WSC.05	1 sheet grain 220	<input type="checkbox"/>	086026
WSC.06	1 sheet grain 240	<input type="checkbox"/>	086033
WSC.07	1 sheet grain 280	<input type="checkbox"/>	086040
WSC.08	1 sheet grain 320	<input type="checkbox"/>	086057
WSC.09	1 sheet grain 360	<input type="checkbox"/>	086064
WSC.10	1 sheet grain 400	<input type="checkbox"/>	086071
WSC.11	1 sheet grain 500	<input type="checkbox"/>	086088
WSC.12	1 sheet grain 600	<input type="checkbox"/>	086095

EMERY CLOTH SHEETS - 230 x 280 mm

355.80	6 sheets grain 60	10	355801
355.82	6 sheets grain 120	10	355825
355.84	6 sheets grain 240	10	355849
355.86	6 sheets assorted grades	10	355863
T.01	1 sheet grain 30	50	085869
T.03	1 sheet grain 40	50	085876
T.04	1 sheet grain 60	50	085883
T.05	1 sheet grain 80	50	085890
T.06	1 sheet grain 100	50	085906
T.07	1 sheet grain 120	50	085913
T.08	1 sheet grain 150	50	085920
T.09	1 sheet grain 180	50	085937
T.10	1 sheet grain 220	50	085944
T.11	1 sheet grain 240	50	085951
T.12	1 sheet grain 320	50	085968
T.13	1 sheet grain 400	50	085975

**FINISHING PAPER ROLL - 120 mm x 50 yds**

RC.01	grain 40	1	085159
RC.03	grain 60	1	085166
RC.04	grain 80	1	085173
RC.05	grain 100	1	085180
RC.06	grain 120	1	085197
RC.07	grain 150	1	085203
RC.08	grain 180	1	085210
RC.09	grain 240	1	085227



FINISHING PAPER ROLL - 120 mm x 5 m

355.90	grain 50	<input checked="" type="checkbox"/>	2	355900
355.92	grain 80	<input checked="" type="checkbox"/>	2	355924
355.94	grain 120	<input checked="" type="checkbox"/>	2	355948

VELCRO FINISHING PAPER ROLL - 120 mm x 3 m

355.96	grain 50	<input checked="" type="checkbox"/>	2	355962
355.97	grain 80	<input checked="" type="checkbox"/>	2	355979
355.98	grain 120	<input checked="" type="checkbox"/>	2	355986

ORBITAL SANDING SHEETS - 93 x 230 mm

356.00	10 sheets grain 50	<input checked="" type="checkbox"/>	10	356006
356.01	25 sheets grain 50	<input type="checkbox"/>	1	356013
356.10	10 sheets grain 80	<input checked="" type="checkbox"/>	10	356105
356.11	25 sheets grain 80	<input type="checkbox"/>	1	356112
356.20	10 sheets grain 120	<input checked="" type="checkbox"/>	10	356204
356.21	25 sheets grain 120	<input type="checkbox"/>	1	356211
356.30	10 sheets assorted grades	<input checked="" type="checkbox"/>	10	356303
356.31	25 sheets assorted grades	<input type="checkbox"/>	1	356310

ORBITAL SANDING SHEETS - 115 x 280 mm

357.00	10 sheets grain 50	<input checked="" type="checkbox"/>	10	357003
357.01	25 sheets grain 50	<input type="checkbox"/>	1	357010
357.10	10 sheets grain 80	<input checked="" type="checkbox"/>	10	357102
357.11	25 sheets grain 80	<input type="checkbox"/>	1	357119
357.20	10 sheets grain 120	<input checked="" type="checkbox"/>	10	357201
357.21	25 sheets grain 120	<input type="checkbox"/>	1	357218
357.30	10 sheets assorted grades	<input checked="" type="checkbox"/>	10	357300
357.31	25 sheets assorted grades	<input type="checkbox"/>	1	357317

ref.

description

pack
q.tyEAN13
8011017**SANDING****VELCRO ABRASIVE SHEETS** with dust extraction holes - **93 x 185** mm

For Atlas Copco, Bosch, Festo, Holzher, Peugeot

354.00	10 sheets grain 40	<input type="checkbox"/> 5	354002
354.03	10 sheets grain 80	<input type="checkbox"/> 5	354033
354.06	10 sheets grain 120	<input type="checkbox"/> 5	354064
354.09	10 sheets grain 180	<input type="checkbox"/> 5	354095
354.12	10 sheets assorted grades	<input type="checkbox"/> 5	354125

**VELCRO ABRASIVE SHEETS** with dust extraction holes - **93 x 185** mm

For Black & Decker KA 186, KA 186E

354.15	10 sheets grain 40	<input type="checkbox"/> 5	354156
354.18	10 sheets grain 80	<input type="checkbox"/> 5	354187
354.21	10 sheets grain 120	<input type="checkbox"/> 5	354217
354.24	10 sheets grain 180	<input type="checkbox"/> 5	354248
354.27	10 sheets assorted grades	<input type="checkbox"/> 5	354279

**ABRASIVE SHEETS** with dust extraction holes - **93 x 230** mm

For Bosch, Festo, Makita, Metabo, Peugeot, Ryobi, Skil, Stayer, Wagner

354.30	10 sheets grain 40	<input type="checkbox"/> 5	354309
354.33	10 sheets grain 80	<input type="checkbox"/> 5	354330
354.36	10 sheets grain 120	<input type="checkbox"/> 5	354361
354.39	10 sheets grain 180	<input type="checkbox"/> 5	354392
354.42	10 sheets assorted grades	<input type="checkbox"/> 5	354422

 PG pack neutral pack

**ABRASIVE SHEETS** with dust extraction holes - **93 x 230** mm

For AEG, Black & Decker, Bosch, Casals, Einhell, Peugeot

354.45	10 sheets grain 40	5	354453
354.48	10 sheets grain 80	5	354484
354.51	10 sheets grain 120	5	354514
354.54	10 sheets grain 180	5	354545
354.57	10 sheets assorted grades	5	354576

**VELCRO ABRASIVE SHEETS** with dust extraction holes - **115 x 230** mm

For AEG, Bosch, Fein, Festo, Holzher, Kress, Mafell, Makita, Peugeot

354.60	10 sheets grain 40	5	354606
354.63	10 sheets grain 80	5	354637
354.66	10 sheets grain 120	5	354668
354.69	10 sheets grain 180	5	354699
354.72	10 sheets assorted grades	5	354729

**ABRASIVE SHEETS** with dust extraction holes - **115 x 280** mm

For AEG, Atlas Copco, Black & Decker, Bosch, Elu, Fein, Festo

354.75	10 sheets grain 40	5	354750
354.78	10 sheets grain 80	5	354781
354.81	10 sheets grain 120	5	354811
354.84	10 sheets grain 180	5	354842
354.87	10 sheets assorted grades	5	354873

ref.

description

pack
q.tyEAN13
8011017**SANDING****SANDING BELTS - 400 x 60 mm**

For Bosch PBS 60/60E

355.10	3 belts grain 40	<input checked="" type="checkbox"/>	355108
355.11	3 belts grain 60	<input checked="" type="checkbox"/>	355115
355.12	3 belts grain 80	<input checked="" type="checkbox"/>	355122
355.13	3 belts grain 100	<input checked="" type="checkbox"/>	355139
355.14	3 belts grain 150	<input checked="" type="checkbox"/>	355146

**SANDING BELTS - 560 x 100 mm**

For Atlas Copco, Elu, Ryobi, Festo

355.15	3 belts grain 40	<input type="checkbox"/>	355153
355.16	3 belts grain 60	<input type="checkbox"/>	355160
355.17	3 belts grain 80	<input type="checkbox"/>	355177
355.18	3 belts grain 100	<input type="checkbox"/>	355184
355.19	3 belts grain 150	<input type="checkbox"/>	355191

**SANDING BELTS - 610 x 100 mm**

For Atlas Copco, Hitachi, Makita, Ryobi, Wolf

355.20	3 belts grain 40	<input type="checkbox"/>	355207
355.21	3 belts grain 60	<input type="checkbox"/>	355214
355.22	3 belts grain 80	<input type="checkbox"/>	355221
355.23	3 belts grain 100	<input type="checkbox"/>	355238
355.24	3 belts grain 150	<input type="checkbox"/>	355245

**SANDING BELTS - 620 x 100 mm**

For Atlas Copco, Bosch, Makita, Metabo

355.25	3 belts grain 40	<input type="checkbox"/>	355252
355.26	3 belts grain 60	<input type="checkbox"/>	355269
355.27	3 belts grain 80	<input type="checkbox"/>	355276
355.28	3 belts grain 100	<input type="checkbox"/>	355283
355.29	3 belts grain 150	<input type="checkbox"/>	355290

 PG pack neutral pack

SANDING BELTS - 533 x 75 mm

For Bosch PBS 75/75E, Atlas Copco, Metabo, Hitachi, Makita, Holz Her



357.35	3 belts grain 40	<input type="checkbox"/>	357355
357.36	3 belts grain 60	<input type="checkbox"/>	357362
357.37	3 belts grain 80	<input type="checkbox"/>	357379
357.38	3 belts grain 100	<input type="checkbox"/>	357386
357.39	3 belts grain 150	<input type="checkbox"/>	357393

SANDING BELTS - 410 x 65 mm

For Black & Decker DN 83/BD 83, Atlas Copco HBS 65, Metabo, Holz Her, Kress



357.40	3 belts grain 40	<input type="checkbox"/>	357409
357.45	3 belts grain 60	<input type="checkbox"/>	357454
357.50	3 belts grain 80	<input type="checkbox"/>	357508
357.55	3 belts grain 100	<input type="checkbox"/>	357553
357.57	3 belts grain 150	<input type="checkbox"/>	357577

SANDING BELTS - 510 x 75 mm

For Black & Decker DN 85/BD 85/SR 500 E



357.60	3 belts grain 40	<input type="checkbox"/>	357607
357.65	3 belts grain 60	<input type="checkbox"/>	357652
357.70	3 belts grain 80	<input type="checkbox"/>	357706
357.75	3 belts grain 100	<input type="checkbox"/>	357751
357.77	3 belts grain 150	<input type="checkbox"/>	357775

SANDING BELTS - 457 x 75 mm

For B&D KA/85, Stayer LN 75, Skil 1200 H/120 SN, Peugeot, Makita



357.78	3 belts grain 40	<input type="checkbox"/>	357782
357.79	3 belts grain 60	<input type="checkbox"/>	357799
357.80	3 belts grain 80	<input type="checkbox"/>	357805
357.81	3 belts grain 100	<input type="checkbox"/>	357812
357.82	3 belts grain 150	<input type="checkbox"/>	357829

ref.

description

pack
q.tyEAN13
8011017**SANDING****DRUM SANDER**

357.96	ø 45 x 30 mm - shank ø 6 mm	10	357966
357.98	3 sanding belts assorted grades for art. 357.96	10	357980

**ROTARY FLAP SANDER** shank ø 6 mm - grain 80

358.40	ø 40 x 20 mm	10	358406
358.50	ø 50 x 20 mm	10	358505
358.60	ø 60 x 40 mm	10	358604
358.80	ø 80 x 30 mm	10	358802
358.90	40 assorted rotary flap sanders in display box 15 ø 40 x 20 mm 15 ø 50 x 20 mm 10 ø 60 x 30 mm	1	358901

**ROTARY FLAP SANDER**

ø x thickness x shank	RPM	grain 60		grain 80		grain 120	
		ref.	EAN13 8011017	ref.	EAN13 8011017	ref.	EAN13 8011017
30 x 10 x 6*	22900	RG.002	085241	RG.037	085418	RG.072	085586
30 x 15 x 6*	22900	RG.004	085258	RG.039	085425	RG.074	085593
30 x 20 x 6*	22900	RG.006	085265	RG.041	085432	RG.076	085609
40 x 10 x 6	17100	RG.011	085272	RG.046	085449	RG.081	085616
40 x 15 x 6	17100	RG.012	085289	RG.047	085456	RG.082	085623
40 x 20 x 6	17100	RG.013	085296	RG.048	085463	RG.083	085630
40 x 30 x 6	17100	RG.015	085302	RG.050	085470	RG.085	085647
50 x 20 x 6	13700	RG.019	085319	RG.054	085487	RG.089	085654
50 x 30 x 6	13700	RG.021	085326	RG.056	085494	RG.091	085661
60 x 20 x 6	11400	RG.024	085333	RG.059	085500	RG.094	085678
60 x 30 x 6	11400	RG.026	085340	RG.061	085517	RG.096	085685
60 x 40 x 6	11400	RG.027	085357	RG.062	085524	RG.097	085692
60 x 50 x 6	11400	RG.028	085364	RG.063	085531	RG.098	085708
80 x 15 x 6	8500	RG.029	085371	RG.064	085548	RG.099	085715
80 x 30 x 6	8500	RG.032	085388	RG.067	085555	RG.102	085722
80 x 40 x 6	8500	RG.033	085395	RG.068	085562	RG.103	085739
80 x 50 x 6	8500	RG.034	085401	RG.069	085579	RG.104	085746

* On demand available with shank ø 3 mm - Packing: 10 pcs. PG pack neutral pack

FLAP SANDING DISC - NYLON SUPPORT

358.00	ø 115 mm - hole ø 22 mm - grain 80	<input checked="" type="checkbox"/>	358000
358.10	ø 115 mm - hole ø 22 mm - grain 40	<input type="checkbox"/>	358109
358.15	ø 115 mm - hole ø 22 mm - grain 80	<input type="checkbox"/>	358154
358.20	ø 115 mm - hole ø 22 mm - grain 120	<input type="checkbox"/>	358208

FLAP SANDING DISC - NYLON SUPPORT

358.05	ø 180 mm - hole ø 22 mm - grain 80	<input checked="" type="checkbox"/>	358055
358.25	ø 180 mm - hole ø 22 mm - grain 40	<input type="checkbox"/>	358253
358.30	ø 180 mm - hole ø 22 mm - grain 80	<input type="checkbox"/>	358307
358.35	ø 180 mm - hole ø 22 mm - grain 120	<input type="checkbox"/>	358352

FLAP SANDING DISC - FIBER GLASS

359.00	ø 115 mm - hole ø 22 mm - grain 80	<input checked="" type="checkbox"/>	359007
359.10	ø 115 mm - hole ø 22 mm - grain 40	<input type="checkbox"/>	359106
359.15	ø 115 mm - hole ø 22 mm - grain 80	<input type="checkbox"/>	359151
359.20	ø 115 mm - hole ø 22 mm - grain 120	<input type="checkbox"/>	359205

FLAP SANDING DISC - FIBER GLASS

359.05	ø 180 mm - hole ø 22 mm - grain 80	<input checked="" type="checkbox"/>	359052
359.25	ø 180 mm - hole ø 22 mm - grain 40	<input type="checkbox"/>	359250
359.30	ø 180 mm - hole ø 22 mm - grain 80	<input type="checkbox"/>	359304
359.35	ø 180 mm - hole ø 22 mm - grain 120	<input type="checkbox"/>	359359

TUNGSTEN CARBIDE DISC - ø 125 mm

345.10	medium grain	<input checked="" type="checkbox"/>	345109
345.20	fine grain	<input checked="" type="checkbox"/>	345208



ref.

description

pack
q.tyEAN13
8011017**CUTTING AND
GRINDING****KNIFE AND SCISSOR SHARPENER**

395.00	∅ 50 mm - exagonal shank 7 mm	10	395005
---------------	---	-----------	--------

**SHARPENING STONE**

395.20	230 mm	10	395203
395.40	230 mm	10/100	395401

**MOUNTED GRINDING POINTS - PINK CORUNDUM**

For metal, glass, ceramics, plastics

396.00	100 assorted mounted grinding points - shank ∅ 6 mm - in display box	1	396002
397.00	45 assorted mounted grinding points - shank ∅ 3/6 mm - in display holder	1	397009
397.20	48 assorted mounted grinding points cylindrical shape - shank ∅ 3 mm - in display box	1	397207
397.30	48 assorted mounted grinding points - shank ∅ 3 mm - in display box	1	397306
397.60	3 assorted chain saw sharpening points - shank ∅ 3 mm	10	397603
398.00	5 assorted mounted grinding points - shank ∅ 3 mm	10	398006
399.00	5 assorted mounted grinding points - shank ∅ 6 mm	10	399003

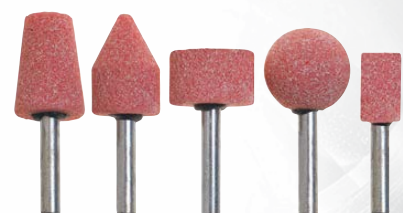

PG pack

neutral pack

MOUNTED GRINDING POINT - PINK CORUNDUM STRAIGHT SHAPE A

2 x 6 x 3	MA.001	083681	12 x 20 x 6	MA.019	083865	30 x 25 x 6	MA.037	084046
3 x 6 x 3	MA.002	083698	12 x 30 x 6	MA.020	083872	30 x 30 x 6	MA.038	084053
4 x 8 x 3	MA.003	083704	15 x 15 x 6	MA.021	083889	30 x 40 x 6	MA.039	084060
5 x 10 x 3	MA.004	083711	15 x 20 x 6	MA.022	083896	35 x 20 x 6	MA.040	084077
6 x 10 x 3	MA.005	083728	15 x 25 x 6	MA.023	083902	35 x 25 x 6	MA.041	084084
8 x 10 x 3	MA.006	083735	15 x 30 x 6	MA.024	083919	35 x 35 x 6	MA.042	084091
10 x 10 x 3	MA.007	083742	15 x 40 x 6	MA.025	083926	40 x 20 x 6	MA.043	084107
12 x 12 x 3	MA.008	083759	20 x 15 x 6	MA.026	083933	40 x 25 x 6	MA.044	084114
15 x 15 x 3	MA.009	083766	20 x 20 x 6	MA.027	083940	40 x 30 x 6	MA.045	084121
4 x 8 x 6	MA.010	083773	20 x 25 x 6	MA.028	083957	40 x 40 x 6	MA.046	084138
5 x 10 x 6	MA.011	083780	20 x 30 x 6	MA.029	083964	50 x 25 x 6	MA.047	084145
6 x 10 x 6	MA.012	083797	20 x 40 x 6	MA.030	083971	50 x 30 x 6	MA.048	084152
8 x 10 x 6	MA.013	083803	25 x 15 x 6	MA.031	083988	50 x 40 x 6	MA.049	084169
10 x 10 x 6	MA.014	083810	25 x 20 x 6	MA.032	083995			
10 x 15 x 6	MA.015	083827	25 x 25 x 6	MA.033	084008			
10 x 20 x 6	MA.016	083834	25 x 30 x 6	MA.034	084015			
10 x 30 x 6	MA.017	083841	25 x 40 x 6	MA.035	084022			
12 x 12 x 6	MA.018	083858	30 x 20 x 6	MA.036	084039			

CENTRE POINT CONE SHAPE B

10 x 15 x 3	MB.001	084190	15 x 25 x 6	MB.004	084220	30 x 40 x 6	MB.007	084251
10 x 15 x 6	MB.002	084206	20 x 30 x 6	MB.005	084237			
10 x 20 x 6	MB.003	084213	25 x 30 x 6	MB.006	084244			

CYLINDRICAL CONE SHAPE C

6 x 8 x 3	MC.001	084268	10 x 15 x 6	MC.005	084305	20 x 30 x 6	MC.009	084343
8 x 12 x 3	MC.002	084275	10 x 20 x 6	MC.006	084312	20 x 40 x 6	MC.010	084350
8 x 12 x 6	MC.003	084282	15 x 20 x 6	MC.007	084329	25 x 40 x 6	MC.011	084367
8 x 20 x 6	MC.004	084299	15 x 25 x 6	MC.008	084336	30 x 40 x 6	MC.012	084374

FLAT SHAPE D

10 x 3,5 x 3	MD.001	084381	30 x 6 x 6	MD.008	084459	40 x 15 x 6	MD.015	084527
10 x 5 x 3	MD.002	084398	30 x 10 x 6	MD.009	084466	50 x 10 x 6	MD.016	084534
15 x 4 x 3	MD.003	084404	30 x 15 x 6	MD.010	084473	50 x 15 x 6	MD.017	084541
20 x 4 x 3	MD.004	084411	35 x 8 x 6	MD.011	084480	60 x 10 x 6	MD.018	084558
20 x 10 x 6	MD.005	084428	35 x 12 x 6	MD.012	084497	70 x 10 x 6	MD.019	084565
25 x 5 x 6	MD.006	084435	40 x 6 x 6	MD.013	084503			
25 x 10 x 6	MD.007	084442	40 x 10 x 6	MD.014	084510			

BALL SHAPE E

4 x 3	ME.001	084572	10 x 3	ME.004	084602	20 x 6	ME.007	084633
6 x 3	ME.002	084589	10 x 6	ME.005	084619	25 x 6	ME.008	084640
8 x 3	ME.003	084596	15 x 6	ME.006	084626	30 x 6	ME.009	084657

∅ ·
thickness
· hole

ref.

EAN13
8011017

∅ ·
thickness
· hole

ref.

EAN13
8011017

∅ ·
thickness
· hole

ref.

EAN13
8011017

**CUTTING AND
GRINDING**

MOUNTED GRINDING POINT - PINK CORUNDUM CONICAL SHAPE F

8 x 12 x 3	MF.001	084671	20 x 25 x 6	MF.004	084701	30 x 40 x 6	MF.007	084732
10 x 15 x 3	MF.002	084688	25 x 30 x 6	MF.005	084718			
10 x 15 x 6	MF.003	084695	30 x 30 x 6	MF.006	084725			



ROUNDED SHAPE G

20 x 10 x 6	MG.001	084756	40 x 10 x 6	MG.003	084770			
30 x 10 x 6	MG.002	084763	40 x 20 x 6	MG.004	084787			



DOUBLE CHAMFER SHAPE H

20 x 6 x 6	MH.001	084794	40 x 10 x 6	MH.003	084817			
30 x 10 x 6	MH.002	084800	50 x 10 x 6	MH.004	084824			



ROUND HEAD SHAPE I

10 x 10 x 3	MI.001	084831	15 x 15 x 6	MI.004	084862	30 x 30 x 6	MI.007	084893
10 x 20 x 6	MI.002	084848	20 x 20 x 6	MI.005	084879			
12 x 12 x 6	MI.003	084855	25 x 25 x 6	MI.006	084886			

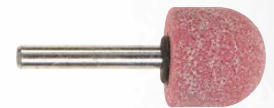

POINTED ARCH SHAPE L

6 x 10 x 3	ML.001	084916	10 x 15 x 6	ML.004	084947	18 x 32 x 6	ML.007	084978
8 x 10 x 3	ML.002	084923	12 x 20 x 6	ML.005	084954	20 x 40 x 6	ML.008	084985
8 x 10 x 6	ML.003	084930	15 x 20 x 6	ML.006	084961			

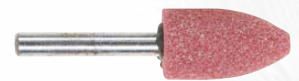

CUP SHAPE M

10 x 20 x 3	MM.001	084992	20 x 20 x 6	MM.004	085029	30 x 30 x 6	MM.007	085050
12 x 20 x 6	MM.002	085005	20 x 30 x 6	MM.005	085036	40 x 20 x 6	MM.008	085067
15 x 20 x 6	MM.003	085012	30 x 20 x 6	MM.006	085043	40 x 30 x 6	MM.009	085074

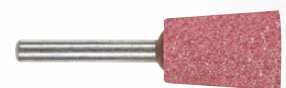

TRUNCATED-CONE SHAPE N

8 x 10 x 3	MN.001	085081	12 x 20 x 6	MN.004	085111	25 x 40 x 6	MN.007	085142
8 x 15 x 3	MN.002	085098	15 x 25 x 6	MN.005	085128			
10 x 15 x 6	MN.003	085104	20 x 30 x 6	MN.006	085135			



Packing: 10 pcs

PG pack

neutral pack

GRINDING WHEEL - GREY CORUNDUM



400.00	ø 75 x 10 mm - hole ø 10 mm	10	400006
402.00	ø 75 x 10 mm - hole ø 13 mm	10	402000
403.00	ø 75 x 10 mm - hole ø 13 mm - SILICON CARBIDE	10	403007
404.00	ø 100 x 12 mm - hole ø 13 mm	10	404004
404.50	ø 125 x 15 mm - hole ø 16 mm	10	404509
405.00	ø 150 x 20 mm - hole ø 16 mm	10	405001

CUTTING DISC for metal



406.00	ø 125 x 2,5 mm - hole ø 13 mm	10	406008
406.95	ø 115 x 1,0 mm - hole ø 22 mm	10	406954
407.00	ø 115 x 1,6 mm - hole ø 22 mm	10	407005
407.05	ø 115 x 1,6 mm - hole ø 22 mm	10	407050

CUTTING DISC for stone



408.00	ø 125 x 2,5 mm - hole ø 13 mm	10	408002
409.00	ø 115 x 1,6 mm - hole ø 22 mm	10	409009
409.05	ø 115 x 1,6 mm - hole ø 22 mm	10	409054

REINFORCED DEPRESSED CENTRE DISC for metal

100 x 3,0 x 16	411.05	-	50	411057
100 x 4,8 x 16	-	412.05	50	412054
115 x 3,2 x 22	413.00	-	10	413006
115 x 3,2 x 22	413.05	-	10	413051
115 x 6,4 x 22	-	414.00	10	414003
115 x 6,4 x 22	-	414.05	10	414058
125 x 3,0 x 22	415.05	-	50	415055
125 x 6,4 x 22	-	416.05	50	416052
150 x 3,2 x 22	416.60	-	25	416601
150 x 6,4 x 22	-	416.80	25	416809
178 x 3,2 x 22	417.00	-	25	417004
178 x 6,4 x 22	-	417.30	25	417301
230 x 3,2 x 22	418.00	-	25	418001
230 x 6,4 x 22	-	418.30	25	418308



REINFORCED DEPRESSED CENTRE DISC for stone

100 x 3,0 x 16	411.55	-	50	411552
100 x 4,8 x 16	-	412.55	50	412559
115 x 3,2 x 22	413.50	-	10	413501
115 x 3,2 x 22	413.55	-	10	413556
115 x 6,4 x 22	-	414.50	10	414508
115 x 6,4 x 22	-	414.55	10	414553
125 x 3,0 x 22	415.55	-	50	415550
125 x 6,4 x 22	-	416.50	25	416502
150 x 3,2 x 22	416.70	-	25	416700
150 x 6,4 x 22	-	416.90	25	416908
178 x 3,2 x 22	417.10	-	25	417103
178 x 6,4 x 22	-	417.50	25	417509
230 x 3,2 x 22	418.10	-	25	418100
230 x 6,4 x 22	-	418.50	25	418506





GRINDING WHEELS

A96 GREY CORUNDUM

C49 GREEN SILICON CARBIDE

dimensions ∅ x thickness x hole	grains						grain
	24	36	46	60	80	100	
75 x 10 x 10				A96.053	A96.078	A96.102	C49.010
75 x 12 x 13				A96.054	A96.079	A96.103	C49.011
100 x 10 x 13				A96.055	A96.080	A96.104	
100 x 13 x 13		A96.204	A96.209	A96.056	A96.214	A96.105	C49.012
100 x 15 x 13	A96.199	A96.205	A96.210	A96.057	A96.082	A96.106	C49.013
100 x 20 x 13	A96.200	A96.206	A96.211	A96.058	A96.083	A96.107	C49.050
125 x 13 x 16		A96.157	A96.166	A96.175	A96.185	A96.191	
125 x 15 x 16	A96.149	A96.158	A96.167	A96.176	A96.186	A96.192	C49.034
125 x 20 x 16	A96.150	A96.127	A96.168	A96.177	A96.187	A96.193	C49.035
125 x 25 x 16	A96.151	A96.160	A96.169	A96.178	A96.188	A96.194	
150 x 16 x 16	A96.001	A96.019	A96.038	A96.063	A96.088	A96.112	C49.051
150 x 20 x 16	A96.002	A96.020	A96.039	A96.064	A96.089	A96.113	C49.016
150 x 20 x 32		A96.207		A96.212			
150 x 25 x 16	A96.003	A96.021	A96.040	A96.065	A96.090	A96.114	C49.017
150 x 30 x 16	A96.004	A96.022	A96.041	A96.066	A96.091	A96.115	
175 x 20 x 20	A96.005	A96.023	A96.042	A96.067	A96.092	A96.116	C49.018
175 x 25 x 20	A96.006	A96.024	A96.043	A96.068	A96.093	A96.117	C49.052
200 x 20 x 20	A96.008	A96.026	A96.045	A96.070	A96.095	A96.119	C49.019
200 x 20 x 32		A96.208		A96.213			
200 x 25 x 20	A96.009	A96.027	A96.046	A96.071	A96.096	A96.120	C49.020
200 x 30 x 20	A96.010	A96.028	A96.047	A96.072	A96.097	A96.121	C49.053
250 x 25 x 25	A96.011	A96.029	A96.048	A96.073	A96.098	A96.122	C49.054
250 x 30 x 25	A96.012	A96.030	A96.049	A96.074	A96.099	A96.123	C49.055
300 x 30 x 30	A96.013	A96.031	A96.050	A96.075	A96.100	A96.124	
300 x 35 x 30	A96.147	A96.155	A96.164	A96.173	A96.182		
300 x 40 x 30	A96.014	A96.032	A96.051	A96.076	A96.101		
400 x 50 x 40	A96.148	A96.033	A96.052	A96.077	A96.184		

Packing: 1 pcs.

PG pack neutral pack

TWO SIDE TAPERED WHEELS - grain 80

dimensions	A96 grey corundum		A99 white corundum		dimensions	A96 grey corundum		A99 white corundum	
	ref.		ref.			ref.		ref.	
ø x thickness x hole					ø x thickness x hole				
125 x 6 x 16	A96C.01		A99C.01		175 x 8 x 20	A96C.08		A99C.08	
125 x 7 x 16	A96C.02		A99C.02		175 x 10 x 20	A96C.09		A99C.09	
125 x 8 x 16	A96C.03		A99C.03		200 x 6 x 20	A96C.10		A99C.10	
150 x 6 x 16	A96C.04		A99C.04		200 x 8 x 20	A96C.11		A99C.11	
150 x 7 x 16	A96C.05		A99C.05		200 x 10 x 20	A96C.12		A99C.12	
150 x 8 x 16	A96C.06		A99C.06		200 x 12 x 20	A96C.14			
150 x 10 x 16	A96C.13		A99C.13		250 x 10 x 25	A96C.15			
175 x 6 x 20	A96C.07		A99C.07		250 x 13 x 25	A96C.16			



WHEEL DRESSERS C48 20T

dimensions	ref.
150 x 20	C48.01
200 x 20	C48.02
200 x 25	C48.03



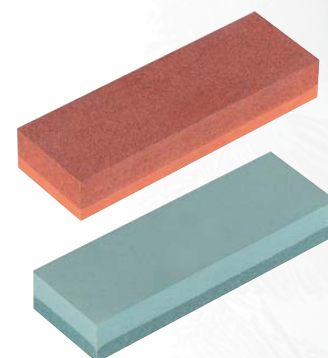

 Packing: 8 pcs.

DOUBLE GRAIN WET STONES

dimensions	C49 green silicon carbide grain 120/400		A99 ruby corundum grain 150/320	
	ref.		ref.	
leng. x width x thick.				
125 x 50 x 20	DG.01		DG.03	
150 x 50 x 25	DG.02		DG.04	

 Packing: 4 pcs.

ABRASIVE FILES

dimensions	grain 80		grain 120		grain 220		SHAPE
	ref.		ref.		ref.		
100 x 13	LTR.001		LTR.004		LTR.007		 triangular
150 x 16	LTR.002		LTR.005		LTR.008		
200 x 20	LTR.003		LTR.006		LTR.009		
100 x 13	LTO.001		LTO.004		LTO.007		 half-round
150 x 16	LTO.002		LTO.005		LTO.008		
200 x 20	LTO.003		LTO.006		LTO.009		
100 x 13	LQU.001		LQU.004		LQU.007		 square
150 x 16	LQU.002		LQU.005		LQU.008		
200 x 20	LQU.003		LQU.006		LQU.009		

 Packing: 10 pcs.

 PG pack

 neutral pack



UNIVERSAL DIAMOND CUTTING DISC TURBO

For cutting of reinforced concrete, roofing tiles, facing, granite

419.60	∅ 115 mm - hole ∅ 22 mm	1	419602
419.65	∅ 230 mm - hole ∅ 22 mm	1	419657



SEGMENTED DIAMOND CUTTING DISC

For cutting of tiles, natural stone, cobblestones, paving slabs

419.70	∅ 115 mm - hole ∅ 22 mm	1	419701
419.75	∅ 230 mm - hole ∅ 22 mm	1	419756



DIAMOND CUTTING DISC WITH CONTINUOUS EDGE

For cutting of tiles, ceramic tiles, half-bricks, marble

419.80	∅ 115 mm - hole ∅ 22 mm	1	419800
419.85	∅ 230 mm - hole ∅ 22 mm	1	419855

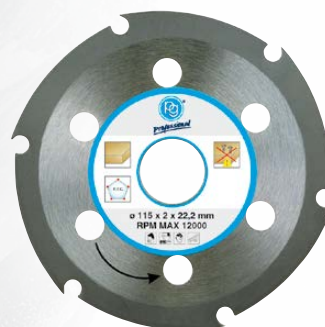













WOOD CUTTING DISC

For milling, cutting and chamfering wood and working on PVC and plastics

419.90	∅ 115 mm - hole ∅ 22 mm	5	419909
419.95	∅ 230 mm - hole ∅ 22 mm	1	419954

WOOD CUTTER - shank \varnothing 8 mm

360.00	\varnothing 35 mm hollow beading cutter 45°		5	360003
361.00	\varnothing 35 mm convex cutter 45°		5	361000
362.00	\varnothing 35 mm coving cutter		5	362007
363.00	\varnothing 35 mm rounding off cutter		5	363004
364.00	\varnothing 25 x 22 mm trimming cutter		5	364001
364.50	\varnothing 25 x 22 mm rounding off cutter		5	364506
365.00	\varnothing 35 mm chamfering cutter 45°		5	365008
366.00	\varnothing 35 x 5 mm straight face cutter		5	366005
367.00	\varnothing 30 x 22 mm tongue cutter		5	367002
368.00	\varnothing 30 x 1,5 mm slotting cutter		5	368009
369.00	\varnothing 30 x 2,5 mm slotting cutter		5	369006
370.00	\varnothing 45 x 1,5 mm slotting saw		5	370002
372.00	\varnothing 6 mm straight cutter - 2 flutes		5	372006

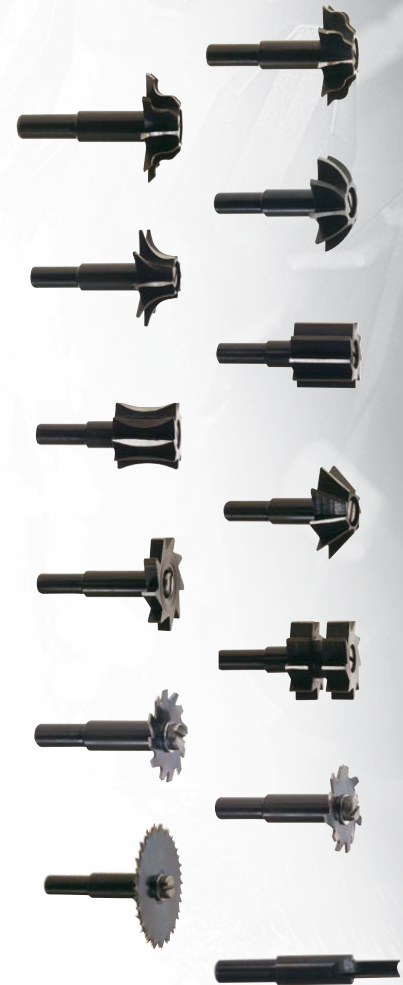
**ADJUSTABLE HAND SHAPER** to be used with wood cutters

373.00	adjustable hand shaper with slotting saw \varnothing 45 mm - 	1	373003
---------------	--	---	--------

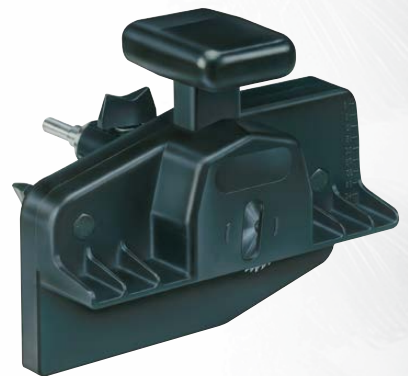
**ADJUSTABLE COUNTERSINK** complete with wood drill bit and depth stop

374.03	\varnothing 3 mm	10	374031
374.04	\varnothing 4 mm	10	374048
374.05	\varnothing 5 mm	10	374055
374.06	\varnothing 6 mm	10	374062



COUNTERSINK - shank \varnothing 6 mm

375.00	\varnothing 6 mm	10	375007
376.00	\varnothing 12 mm	10	376004
377.00	\varnothing 16 mm	10	377001
378.00	\varnothing 19 mm	10	378008

**COUNTERSINK - shank \varnothing 5 mm**

379.00	\varnothing 13 mm	10	379005
---------------	---------------------	----	--------

**COUNTERSINK - hexagonal shank 1/4"**

451.10	\varnothing 10 mm	5	451107
451.20	\varnothing 13 mm	5	451206
451.30	\varnothing 16 mm	5	451305

**HAND COUNTERSINK**

451.00	\varnothing 12 mm - 5 cutters	10	451008
---------------	---------------------------------	----	--------

**HINGE BORING BIT - shank \varnothing 8 mm**

379.50	\varnothing 20 mm	10	379500
380.00	\varnothing 26 mm	10	380001
381.00	\varnothing 30 mm	10	381008
382.00	\varnothing 35 mm	10	382005
383.00	\varnothing 38 mm	10	383002

**HINGE BORING BIT CARBIDE TIPPED - shank \varnothing 8 mm**

384.00	\varnothing 26 mm	5	384009
384.10	\varnothing 30 mm	5	384108
384.20	\varnothing 35 mm	5	384207



ref.

description

pack
q.tyEAN13
8011017**FLAT WOOD
DRILLS AND
FORSTNER BITS****FLAT WOOD BORING DRILL BIT - shank \varnothing 6 mm**

384.50	\varnothing 6 mm	10	384504
385.00	\varnothing 8 mm	10	385006
386.00	\varnothing 10 mm	10	386003
387.00	\varnothing 12 mm	10	387000
388.00	\varnothing 14 mm	10	388007
389.00	\varnothing 16 mm	10	389004
390.00	\varnothing 18 mm	10	390000
391.00	\varnothing 20 mm	10	391007
392.00	\varnothing 22 mm	10	392004
392.50	\varnothing 24 mm	10	392509
393.00	\varnothing 25 mm	10	393001
393.20	\varnothing 26 mm	10	393209
393.40	\varnothing 28 mm	10	393407
393.60	\varnothing 30 mm	10	393605
394.00	\varnothing 32 mm	10	394008
394.20	\varnothing 35 mm	10	394206
394.40	\varnothing 38 mm	10	394404

**EXPANSIVE WOOD BORING DRILL BIT**

394.70	\varnothing 15/45 mm - shank \varnothing 6 mm	2	394701
394.80	\varnothing 22/76 mm - shank \varnothing 10 mm	2	394800

**EXTENSION SHANK FOR FLAT WOOD DRILLS - shank \varnothing 6 mm**

394.84	150 mm	5	394848
394.86	300 mm	5	394862

 PG pack

 neutral pack

FORSTNER BIT - DIN 7483
90 mm lenght - shank \varnothing 8 mm

12.010	\varnothing 10 mm	1	120102
12.012	\varnothing 12 mm	1	120126
12.014	\varnothing 14 mm	1	120140
12.015	\varnothing 15 mm	1	120157
12.016	\varnothing 16 mm	1	120164
12.018	\varnothing 18 mm	1	120188
12.020	\varnothing 20 mm	1	120201
12.022	\varnothing 22 mm	1	120225
12.024	\varnothing 24 mm	1	120249
12.025	\varnothing 25 mm	1	120256
12.026	\varnothing 26 mm	1	120263
12.028	\varnothing 28 mm	1	120287
12.030	\varnothing 30 mm	1	120300
12.032	\varnothing 32 mm - shank \varnothing 10 mm	1	120324
12.034	\varnothing 34 mm - shank \varnothing 10 mm	1	120348
12.035	\varnothing 35 mm - shank \varnothing 10 mm	1	120355
12.036	\varnothing 36 mm - shank \varnothing 10 mm	1	120362
12.040	\varnothing 40 mm - shank \varnothing 10 mm	1	120409
12.045	\varnothing 45 mm - shank \varnothing 10 mm	1	120454
12.050	\varnothing 50 mm - shank \varnothing 10 mm	1	120508



ref.

description

pack
q.tyEAN13
8011017**RASPING****ROTARY FILE** for metal - shank \varnothing 6 mm

420.00	cylindrical rotary file	10	420004
422.00	conical rotary file	10	422008
424.00	cylindrical rounded rotary file	10	424002
426.00	spherical rotary file	10	426006
445.00	metal HSS drill saw \varnothing 6 x 85 mm	10	445007

**ROTARY FILE** for metal - shank 1/4"

445.20	conical rotary file	5	445205
445.30	cylindrical rounded rotary file	5	445304

**ROTARY RASP** for wood - shank \varnothing 6 mm

430.00	cylindrical rotary rasp	10	430003
432.00	conical rotary rasp	10	432007
434.00	spherical rotary rasp	10	434001
436.00	dome rotary rasp	10	436005
438.00	rotary countersink	10	438009
440.00	wood drill saw \varnothing 6 x 90 mm	10	440002

**ROTARY RASP** for wood - shank 1/4"

440.20	conical rotary rasp	5	440200
440.40	cylindrical rounded rotary rasp	5	440408

**ASSORTED FILES AND RASPS** - shank \varnothing 6 mm

446.00	3 assorted rotary rasps	10	446004
447.00	6 assorted rotary files and rasps	5	447001

 PG pack neutral pack

WOOD RASP - shank \varnothing 6 mm

448.00	\varnothing 10/15 mm	10	448008
448.10	\varnothing 15/20 mm	10	448107
448.20	\varnothing 20/25 mm	10	448206

FILE AND RASP for metal and wood

449.06	length 6" - 150 mm	10	449067
449.08	length 8" - 200 mm	10	449081

ASSORTED FILES - 4" length - 100 mm

449.20	6 files equalling - flat - halfround - round - three square - square shape	5	449203
---------------	--	---	--------

ROUND CHAIN SAW FILES - 8" length - 200 mm

449.40	2 files \varnothing 5/32" - 4,0 mm	10	449401
449.45	12 files \varnothing 5/32" - 4,0 mm	2	449456
449.50	2 files \varnothing 3/16" - 4,8 mm	10	449500
449.55	12 files \varnothing 3/16" - 4,8 mm	2	449555
449.60	2 files \varnothing 7/32" - 5,6 mm	10	449609
449.65	12 files \varnothing 7/32" - 5,6 mm	2	449654

MAGNETIC BIT HOLDERFor bits with hexagonal shank **1/4"**

452.00	hexagonal shank 1/4" - 60 mm length	10	452005
452.05	with quick release - hexagonal shank 1/4" - 60 mm length	5	452050
452.10	with ring magnet and depth stop - hexagonal shank 1/4" - 60 mm length - for drywall	5	452104
452.15	flexible - hexagonal shank 1/4" - 190 mm length	5	452159
452.20	SDS-plus shank - 75 mm length	5	452203

**90° ANGLE SCREWDRIVER**

452.30	with hexagonal receptacle 1/4"	5	452302
---------------	---------------------------------------	---	--------

**BITS FOR TORX SCREWS - 25 mm length**

452.40	2 bits T10	10	452401
452.50	2 bits T15	10	452500
452.60	2 bits T20	10	452609
452.70	2 bits T25	10	452708
452.80	2 bits T30	10	452807
452.90	2 bits T40	10	452906

**TITANIUM BITS FOR TORX SCREWS - 25 mm length**

452.92	2 bits T10	5	452920
452.93	2 bits T15	5	452937
452.94	2 bits T20	5	452944
452.95	2 bits T25	5	452951
452.96	2 bits T30	5	452968
452.97	2 bits T40	5	452975



ALLEN KEY BITS - 25 mm length

453.00	2 bits 2 mm	10	453002
453.10	2 bits 2,5 mm	10	453101
453.20	2 bits 3 mm	10	453200
453.30	2 bits 4 mm	10	453309
453.40	2 bits 5 mm	10	453408
453.50	2 bits 6 mm	10	453507

PHILLIPS BITS - 25 mm length

454.00	2 bits n. 1	10	454009
455.00	2 bits n. 2	10	455006
456.00	2 bits n. 3	10	456003
456.20	1 bit n. 4	10	456201

TITANIUM PHILLIPS BITS - 25 mm length

456.50	2 bits n. 1	5	456508
456.52	2 bits n. 2	5	456522
456.54	2 bits n. 3	5	456546

SLOT BITS - 25 mm length

457.00	2 bits 0,8 x 4 mm	10	457000
458.00	2 bits 0,8 x 5 mm	10	458007
459.00	2 bits 1,0 x 6 mm	10	459004
459.20	2 bits 1,2 x 7,2 mm	10	459202
459.40	2 bits 1,6 x 8 mm	10	459400

TITANIUM SLOT BITS - 25 mm length

459.50	2 bits 0,8 x 4 mm	5	459509
459.52	2 bits 0,8 x 5 mm	5	459523
459.54	2 bits 1,0 x 6 mm	5	459547

ref.

description

pack
q.tyEAN13
8011017**BITS****POZIDRIV BITS - 25 mm length**

459.90	2 bits n. 0	10	459905
460.00	2 bits n. 1	10	460000
460.10	2 bits n. 2	10	460109
460.20	2 bits n. 3	10	460208
460.30	1 bits n. 4	10	460307

**TITANIUM POZIDRIV BITS - 25 mm length**

460.50	2 bits n. 0	5	460505
460.52	2 bits n. 1	5	460529
460.54	2 bits n. 2	5	460543
460.56	2 bits n. 3	5	460567

**DOUBLE FUNCTION BIT - 60 mm length**

461.00	slot 0,8 x 4 mm + Phillips n. 1	10	461007
462.00	slot 0,8 x 5 mm + Phillips n. 2	10	462004
462.50	slot 1,2 x 7,2 mm + Phillips n. 3	10	462509

**BITS ASSORTMENT**

463.00	7 pcs: magnetic bit holder + Phillips 1 - 2 + Pozidriv 1 - 2 + slot 4 - 5 mm	5	463001
463.50	7 pcs: magnetic bit holder + Torx T10 - T15 - T20 - T25 - T30 - T40	5	463506
464.00	10 pcs: magnetic bit holder + Phillips 1 - 2 - 3 + Pozidriv 1 - 2 - 3 + slot 4 - 5 - 6 mm	5	464008
PG32A	32 pcs: quick magnetic bit holder + Phillips 1 - 2 - 2 - 3 + Pozidriv 1 - 2 - 2 - 3 + slot 3 - 4 - 5 - 6 mm + hexagonal 3 - 4 - 5 - 6 mm + T10 - T15 - T20 - T25 - T27 - T30 - T40 + Torx holed T10 - T15 - T20 - T25 - T27 - T30 - T40 + square adapter 1/4" to 1/4" hexagonal	1	071046



PG pack

neutral pack

**BRASS WIRE WHEEL BRUSH** - shank \varnothing 6 mm

490.00	\varnothing 75 mm	<input checked="" type="checkbox"/>	490007
---------------	---------------------	-------------------------------------	--------

**BRASS WIRE CUP BRUSH** - shank \varnothing 6 mm

495.00	\varnothing 50 mm	<input checked="" type="checkbox"/>	495002
---------------	---------------------	-------------------------------------	--------

**STEEL WIRE CONICAL WHEEL BRUSH** - shank \varnothing 6 mm

466.00	\varnothing 90 mm	<input checked="" type="checkbox"/>	466002
466.01	20 brushes art. 466.00 bulk	<input type="checkbox"/>	466019

**STEEL WIRE CONICAL WHEEL BRUSH** - bore M14

467.00	\varnothing 90 mm	<input checked="" type="checkbox"/>	467009
467.01	20 brushes art. 467.00 bulk	<input type="checkbox"/>	467016
468.00	\varnothing 120 mm	<input checked="" type="checkbox"/>	468006
468.01	20 brushes art. 468.00 bulk	<input type="checkbox"/>	468013
468.20	\varnothing 150 mm	<input checked="" type="checkbox"/>	468204
468.30	\varnothing 100 mm - twisted wire	<input checked="" type="checkbox"/>	468303
468.35	\varnothing 120 mm - twisted wire	<input checked="" type="checkbox"/>	468358
468.40	\varnothing 150 mm - twisted wire	<input checked="" type="checkbox"/>	468402



STEEL WIRE WHEEL BRUSH - shank \varnothing 6 mm

468.50	\varnothing 40 mm	<input checked="" type="checkbox"/>	10	468501
468.51	20 brushes art. 468.50 bulk	<input type="checkbox"/>	1	468518
469.00	\varnothing 50 mm	<input checked="" type="checkbox"/>	10	469003
469.01	20 brushes art. 469.00 bulk	<input type="checkbox"/>	1	469010
470.00	\varnothing 75 mm	<input checked="" type="checkbox"/>	10	470009
470.01	20 brushes art. 470.00 bulk	<input type="checkbox"/>	1	470016
470.50	\varnothing 75 mm - double thickness	<input checked="" type="checkbox"/>	10	470504
475.00	\varnothing 100 mm	<input checked="" type="checkbox"/>	10	475004
475.01	20 brushes art. 475.00 bulk	<input type="checkbox"/>	1	475011
475.50	\varnothing 100 mm - double thickness	<input checked="" type="checkbox"/>	10	475509
475.65	\varnothing 75 mm - twisted wire	<input checked="" type="checkbox"/>	5	475653
475.70	\varnothing 100 mm - twisted wire	<input checked="" type="checkbox"/>	5	475707



STEEL WIRE WHEEL BRUSH

485.80	\varnothing 75 mm - hole \varnothing 13 mm	<input checked="" type="checkbox"/>	10	485805
486.00	\varnothing 100 mm - hole \varnothing 13 mm	<input checked="" type="checkbox"/>	10	486000
487.00	\varnothing 120 mm - hole \varnothing 16 mm	<input checked="" type="checkbox"/>	10	487007
488.00	\varnothing 150 mm - hole \varnothing 32/20/16 mm	<input checked="" type="checkbox"/>	10	488004
489.00	\varnothing 200 mm - hole \varnothing 32/20/16 mm thickness 20 mm	<input type="checkbox"/>	1	489001
489.50	\varnothing 200 mm - hole \varnothing 32/20/16 mm thickness 40 mm	<input type="checkbox"/>	1	489506



MINI STEEL WIRE BRUSHES - shank \varnothing 2,35 mm

476.00	3 assorted mini wire brushes - \varnothing 5 - 12 - 21 mm	<input checked="" type="checkbox"/>	10	476001
---------------	--	-------------------------------------	----	--------

STEEL WIRE END BRUSH - shank \varnothing 6 mm

477.00	\varnothing 16 mm	<input checked="" type="checkbox"/>	10	477008
---------------	---------------------	-------------------------------------	----	--------

477.01	20 brushes art. 477.00 bulk	<input type="checkbox"/>	1	477015
---------------	---	--------------------------	---	--------

478.00	\varnothing 25 mm	<input checked="" type="checkbox"/>	10	478005
---------------	---------------------	-------------------------------------	----	--------

478.01	20 brushes art. 478.00 bulk	<input type="checkbox"/>	1	478012
---------------	---	--------------------------	---	--------

STEEL WIRE MUSHROOM SHAPE END BRUSH - shank \varnothing 6 mm

478.20	\varnothing 30 mm	<input checked="" type="checkbox"/>	10	478203
---------------	---------------------	-------------------------------------	----	--------

478.40	\varnothing 40 mm	<input checked="" type="checkbox"/>	10	478401
---------------	---------------------	-------------------------------------	----	--------

STEEL WIRE SPIRAL BRUSH - shank \varnothing 6 mm

478.80	\varnothing 16 mm	<input checked="" type="checkbox"/>	10	478807
---------------	---------------------	-------------------------------------	----	--------

478.90	\varnothing 20 mm	<input checked="" type="checkbox"/>	10	478906
---------------	---------------------	-------------------------------------	----	--------

479.00	\varnothing 28 mm	<input checked="" type="checkbox"/>	10	479002
---------------	---------------------	-------------------------------------	----	--------

479.01	20 brushes art. 479.00 bulk	<input type="checkbox"/>	1	479019
---------------	---	--------------------------	---	--------

479.10	\varnothing 38 mm	<input checked="" type="checkbox"/>	10	479101
---------------	---------------------	-------------------------------------	----	--------

ref.

description

pack
q.tyEAN13
8011017**BRUSHING****STEEL WIRE CUP BRUSH - shank ø 6 mm**

480.00	ø 50 mm	<input checked="" type="checkbox"/>	10	480008
480.01	20 brushes art. 480.00 bulk	<input type="checkbox"/>	1	480015
485.00	ø 70 mm	<input checked="" type="checkbox"/>	10	485003
485.01	20 brushes art. 485.00 bulk	<input type="checkbox"/>	1	485010
485.20	ø 85 mm	<input checked="" type="checkbox"/>	10	485201
485.21	20 brushes art. 485.20 bulk	<input type="checkbox"/>	1	485218

**STEEL WIRE CUP BRUSH - bore M14**

485.30	ø 60 mm	<input checked="" type="checkbox"/>	10	485300
485.31	20 brushes art. 485.30 bulk	<input type="checkbox"/>	1	485317
485.40	ø 85 mm	<input checked="" type="checkbox"/>	10	485409
485.41	20 brushes art. 485.40 bulk	<input type="checkbox"/>	1	485416
485.50	ø 100 mm	<input checked="" type="checkbox"/>	5	485508
485.51	10 brushes art. 485.50 bulk	<input type="checkbox"/>	1	485515
485.60	ø 120 mm	<input checked="" type="checkbox"/>	5	485607
485.61	5 brushes art. 485.60 bulk	<input type="checkbox"/>	1	485614
485.65	ø 150 mm	<input checked="" type="checkbox"/>	5	485652
485.70	ø 75 mm - twisted wire	<input checked="" type="checkbox"/>	5	485706
485.75	ø 85 mm - twisted wire	<input checked="" type="checkbox"/>	5	485751
485.76	ø 100 mm - twisted wire	<input type="checkbox"/>	1	485768
485.77	ø 120 mm - twisted wire	<input type="checkbox"/>	1	485775

 PG pack neutral pack

ABRASIVE NYLON WIRE WHEEL BRUSH - shank \varnothing 6 mm

497.05	\varnothing 75 mm - orange grain 80	5	497051
497.10	\varnothing 75 mm - blue grain 150	5	497105
497.15	\varnothing 100 mm - orange grain 80	5	497150
497.20	\varnothing 100 mm - blue grain 150	5	497204

ABRASIVE NYLON WIRE CUP BRUSH - shank \varnothing 6 mm

497.25	\varnothing 50 mm - orange grain 80	5	497259
497.30	\varnothing 50 mm - blue grain 150	5	497303
497.35	\varnothing 70 mm - orange grain 80	5	497358
497.40	\varnothing 70 mm - blue grain 150	5	497402

ABRASIVE NYLON WIRE END BRUSH - shank \varnothing 6 mm

497.45	\varnothing 25 mm - orange grain 80	5	497457
497.50	\varnothing 25 mm - blue grain 150	5	497501

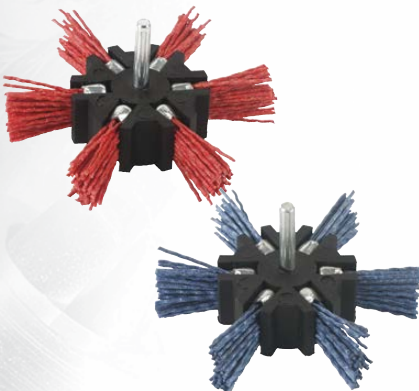
ABRASIVE NYLON WIRE FLAP BRUSH - shank \varnothing 6 mm

497.55	\varnothing 100 mm - orange grain 80	5	497556
497.60	\varnothing 100 mm - blue grain 150	5	497600

ref.

description

pack
q.tyEAN13
8011017**BRUSHING****STEEL WIRE BRUSHES ASSORTMENT** in display box

496.00	40 wire brushes:	1	496009
	10 art. 469.00 - 10 art. 470.00		
	10 art. 480.00 - 10 art. 485.00		

**ABRASIVE NYLON WIRE BRUSHES ASSORTMENT** in display box

496.50	30 nylon brushes:	1	496504
	3 each of art. 497.05 - 10 - 15 - 20 - 25 - 30 - 35 -		
	40 - 45 - 50		

**HAND BRUSHES ASSORTMENT** in display box

496.90	24 hand brushes:	1	496900
	8 each of art. 496.93 - 496.96 - 496.99		

 PG pack

 neutral pack

**HAND BRUSH** in display box

497.00 steel wire

24

497006

**HAND BRUSH** in display box

496.99 stainless steel wire

24

496993

**HAND BRUSH** in display box

496.96 brass wire

24

496962

**HAND BRUSH** in display box

496.93 abrasive nylon wire

24

496931

ref.

description

pack
q.tyEAN13
8011017**BRUSHING****MINI HAND BRUSH****496.82** steel wire

12

496825

**MINI HAND BRUSH****496.84** stainless steel wire

12

496849

**MINI HAND BRUSH****496.85** brass wire

12

496856

**MINI HAND BRUSH****496.88** nylon wire

12

496887

 PG pack neutral pack

**KIT 5 STEEL WIRE BRUSHES**

497.02	wheel brush \varnothing 50 mm + wheel brush \varnothing 75 mm	3	497020
	+ cup brush \varnothing 50 mm + cup brush \varnothing 70 mm + end brush \varnothing 16 mm		

**KIT 4 STEEL WIRE BRUSHES**

497.04	wheel brush \varnothing 75 mm + cup brush \varnothing 50 mm	10	497044
	+ end brush \varnothing 25 mm + hand brush		

ref.

description

pack
q.tyEAN13
8011017**BRUSHING**

Total items 15		Total pcs 134		
Professional				
10x 476.00	10x 469.00	10x 477.00	10x 478.00	10x 479.00
10x 470.00	10x 475.00	10x 480.00		
10x 485.00	10x 485.20	10x 485.40		
7x 485.30		7x 485.70		
5x 485.50		5x 485.75		

BRUSHES DISPLAYER

ESPO.S1

- height **80** cm
- width **37** cm
- depth **32** cm

1

087450



Total items 8		Total pcs 94	
Professional			
10x 478.00	10x 479.00	10x 470.00	
10x 475.00	10x 485.00		
10x 485.20	10x 485.40		
24x 497.00			

BRUSHES DISPLAYER

ESPO.S2

- height **70** cm
- width **28** cm
- depth **34** cm

1

087702

PG pack

neutral pack

SAFETY GOGGLES



498.00	welding goggles - CE - EN 166	5	498003
498.50	double lenses welding goggles - CE - EN 166	5	498508
498.60	professional double lenses welding goggles - CE - EN 166	1	498607

SAFETY GOGGLES



500.00	professional - with side arms and side protections - CE - EN 166	1	500003
500.25	professional - even fit over your glasses - with side protections - CE - EN 166	1	500256
500.35	professional - with side protections - CE - EN 166	1	500355

SAFETY GOGGLES



501.00	diy model - not DPI	5	501000
501.20	with direct ventilation - CE - EN 166	1	501208
501.40	with indirect ventilation - CE - EN 166	1	501406
501.60	professional - with indirect ventilation - high protection - CE - EN 166	1	501604

DUST PROTECTION MASK

502.00	5 masks - not DPI	10	502007
502.50	50 masks - not DPI	1	502502
502.60	2 masks against non toxic aerosols - CE - EN 149 FFP1	10	502601
502.70	2 masks against non toxic solid and water based aerosols valved active carbon - CE - EN 149 FFP1	5	502700
503.00	1 reinforced mask - not DPI	10	503004

**RESPIRATOR AND REPLACEMENT FILTER**

504.00	respirator with filter for dust - not DPI	5	504001
504.20	replacement dust filter - not DPI	5	504209
504.40	replacement gas filter - not DPI	5	504407

**RESPIRATOR AND REPLACEMENT FILTER**

504.50	respirator with filter A1 against organic vapours, paints, solvents - CE - EN 140/141	1	504506
504.55	replacement filter A1 against organic vapours, paints, solvents - CE - EN 140/141	2	504551
504.58	replacement filter P3 against fine dusts and aerosols - CE - EN 140/143	2	504582



RESPIRATOR WITH TWO FILTERS AND REPLACEMENT FILTER



504.70	respirator with 2 filters A1 against organic vapours, paints, solvents - CE - EN 140/141	1	504704
504.75	replacement filter A1 against organic vapours, paints, solvents - CE - EN 140/141	2	504759
504.78	replacement filter P3 against fine dusts and aerosols - CE - EN 140/143	2	504780

EAR PROTECTOR



505.00	diy model - not DPI	5	505008
505.20	medium/high level of noise reduction - CE - EN 352-1	1	505206
505.40	high level of noise reduction - professional - CE - EN 352-1	1	505404



HEALTH AND SAFETY KIT - CE

505.50	safety goggles EN166 + dust protection mask EN149 + ear plugs EN352-2 + ear protector EN352-1	1	505503
---------------	---	----------	--------

EAR PLUGS



505.80	3 pairs ear plugs in polyurethane foam - CE - EN 352-3	10	505800
505.83	5 pairs double layer ear plugs - high comfort - CE - EN 352-3	10	505831
505.86	1 pair triple flange ear plugs with neck string - CE - EN 352-2	10	505862

PG pack neutral pack

**NITRILE GLOVES - HIGH DENSITY**Professional use - **CE** - EN388 - EN455 1 & 2

506.10	Size M	50 disposable gloves: - hypo-allergenic - latex free	1	506104
506.11	Size L	- with vegetable anti sweat powders - rolled cuff	1	506111
506.12	Size XL	- ambidextrous fit - long wrist	1	506128

**NITRILE GLOVES**Professional use - **CE** - EN455 1 & 2

506.15	Size M	50 disposable gloves: - hypo-allergenic - latex free	1	506159
506.16	Size L	- with vegetable anti sweat powders - rolled cuff	1	506166
506.17	Size XL	- ambidextrous fit - long wrist	1	506173

**RUBBER KNEE PADS**

506.50	knee pads	1	506500
---------------	-----------	----------	--------

**SAFETY HELMET**

506.60	safety helmet - CE - EN 397	1	506609
---------------	------------------------------------	----------	--------



MIXER

For cement, paints, glue and other liquids



507.00	∅ 80 x 400 mm - shank hex. 8	5	507002
508.00	∅ 100 x 500 mm - shank hex. 8	2	508009
509.00	∅ 120 x 600 mm - shank hex. 10	2	509006

MIXER

For cement, paints, glue and other liquids



509.40	∅ 130 x 600 mm - shank hex. 10	2	509402
---------------	--	----------	--------

MIXER

For colors, paints, glue and other liquids



510.00	∅ 60 x 350 mm - shank ∅ 6 mm	10	510002
511.00	∅ 60 x 400 mm - shank hex. 8	5	511009
512.00	∅ 80 x 400 mm - shank hex. 8	5	512006
513.00	∅ 100 x 600 mm - shank hex. 10	2	513003
514.00	∅ 120 x 600 mm - shank hex. 12	2	514000
514.10	∅ 125 x 600 mm - shank hex. 10 - double helix	2	514109

ref.

description

pack
q.tyEAN13
8011017

KNIVES

PROFESSIONAL KNIFE

566.00	automatic-safety model metal body	4	566009
566.05	changing of blades without tools metal body - with 5 blades included	4	566054
566.11	blade self loading system - 3 blades positions - with 5 blades included	2	566115

**PROFESSIONAL CUTTER**

With retractable snap-off blade and safety stop

566.12	25 mm blade - metal guide blade and non-slip handle	12	566122
566.14	9 mm blade - metal guide blade and non-slip handle with 3 blades included	24	566146
566.16	18 mm blade - metal guide blade and non-slip handle with 3 blades included	24	566160

**CUTTER** - In display boxPositive blade auto lock - Blade storage lock with 3 blades -
Blade self loading system

566.17	9 mm blade - with metal guide blade and bi-material body with 3 blades included	12	566177
566.18	18 mm blade - with metal guide blade and bi-material body with 3 blades included	12	566184

**CUTTER**

With retractable snap-off blade and safety stop

566.20	9 mm blade - metal body	24	566207
566.23	9 mm blade - ABS body	24	566238
566.25	9 mm blade - metal guide blade	24	566252



PG pack

neutral pack

CUTTER

With retractable snap-off blade and safety stop



566.30	9 mm blade - ABS body	24	566306
566.40	18 mm blade - ABS body	24	566405
566.50	18 mm blade - metal guide blade	24	566504
566.60	18 mm blade - metal guide blade	24	566603



SCRAPER

567.00	scraper with retractable blade	24	567006
---------------	--------------------------------	----	--------

REPLACEMENT BLADES



568.00	5 medium heavy-duty blades	12	568003
568.10	5 large heavy-duty blades	12	568102
568.20	5 hook blades	12	568201
568.30	10 snap-off 9 mm blades	12	568300
568.40	10 snap-off 18 mm blades	12	568409
568.50	5 snap-off 25 mm blades	12	568508



GLASS CUTTER

569.00	with hard metal wheel	5	569000
---------------	-----------------------	---	--------

PG pack
 neutral pack

ref.

description

pack
q.tyEAN13
8011017**WOOD TOOLS****WOOD CARVING TOOLS**

570.00	5 wood carving tools	<input checked="" type="checkbox"/>	2	570006
572.00	6 wood carving tools	<input checked="" type="checkbox"/>	2	572000

**FLAT CHISEL** wooden handle

575.00	6 mm	<input checked="" type="checkbox"/>	5	575001
576.00	8 mm	<input checked="" type="checkbox"/>	5	576008
577.00	10 mm	<input checked="" type="checkbox"/>	5	577005
578.00	12 mm	<input checked="" type="checkbox"/>	5	578002
579.00	14 mm	<input checked="" type="checkbox"/>	5	579009
580.00	16 mm	<input checked="" type="checkbox"/>	5	580005
581.00	18 mm	<input checked="" type="checkbox"/>	5	581002
582.00	20 mm	<input checked="" type="checkbox"/>	5	582009
583.00	26 mm	<input checked="" type="checkbox"/>	5	583006
584.00	30 mm	<input checked="" type="checkbox"/>	5	584003
585.00	32 mm	<input checked="" type="checkbox"/>	5	585000
586.00	40 mm	<input checked="" type="checkbox"/>	5	586007

**WOOD GIMLET**

590.00	∅ 2 mm	<input checked="" type="checkbox"/>	10	590004
591.00	∅ 3 mm	<input checked="" type="checkbox"/>	10	591001
592.00	∅ 4 mm	<input checked="" type="checkbox"/>	10	592008
593.00	∅ 5 mm	<input checked="" type="checkbox"/>	10	593005
594.00	∅ 6 mm	<input checked="" type="checkbox"/>	10	594002
595.00	∅ 8 mm	<input checked="" type="checkbox"/>	10	595009
597.00	3 wood gimlets ∅ 2 - 3 - 4 mm	<input checked="" type="checkbox"/>	10	597003

 PG pack neutral pack

**TACK LIFTER**

598.00	190 mm	<input checked="" type="checkbox"/>	598000
---------------	---------------	-------------------------------------	--------

WOODEN AND REBATE PLANE

Smoothing steel blade

624.00	36 mm	<input checked="" type="checkbox"/>	624006
625.00	45 mm - double steel blade	<input checked="" type="checkbox"/>	625003
626.00	48 mm - double steel blade	<input checked="" type="checkbox"/>	626000
628.00	24 mm	<input checked="" type="checkbox"/>	628004
629.00	27 mm	<input checked="" type="checkbox"/>	629001

**STEEL BLADE**

624.10	36 mm - for art. 624.00	<input checked="" type="checkbox"/>	624105
625.10	45 mm - for art. 625.00	<input checked="" type="checkbox"/>	625102
626.10	48 mm - for art. 626.00	<input checked="" type="checkbox"/>	626109
628.10	24 mm - for art. 628.00	<input checked="" type="checkbox"/>	628103
629.10	27 mm - for art. 629.00	<input checked="" type="checkbox"/>	629100

**HARD METAL PLANER BLADES**

ref.	description	suitable with:	q.ty	EAN13 8011017
629.85	2 blades 75,5 x 5,5 x 1,1 mm	AEG - B&D - Bosch - Festo - Haffner - Holz Her - Kress - Mafell - Metabo - Scheer - Skil	<input checked="" type="checkbox"/>	629858
629.87	2 blades 80,5 x 5,9 x 1,1 mm	Elu - B&D	<input checked="" type="checkbox"/>	629872
629.89	2 blades 82,0 x 5,5 x 1,1 mm	AEG - B&D - Bosch - Fein - Felisatti - Festo - Haffner - Hitachi - Holz Her - Mafell - Makita - Metabo - Skil	<input checked="" type="checkbox"/>	629896
629.93	2 blades 102,0 x 5,5 x 1,1 mm	AEG	<input checked="" type="checkbox"/>	629933

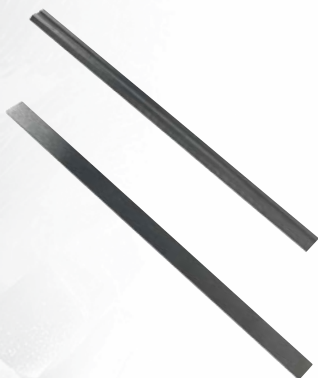

ref.

description

pack
q.tyEAN13
8011017**STAPLING****TACKER**

601.00	diy model for home and hobby accepts staples 4 - 6 - 8 mm	<input type="checkbox"/> 1	601007
604.00	metal body for home and work - adjustable force accepts staples from 4 to 14 mm	<input type="checkbox"/> 1	604008

**STAPLES**

607.30	5000 staples 6 mm	<input type="checkbox"/> 5	607306
607.35	1000 staples 6 mm	<input checked="" type="checkbox"/> 10	607351
607.40	5000 staples 8 mm	<input type="checkbox"/> 5	607405
607.45	1000 staples 8 mm	<input checked="" type="checkbox"/> 10	607450
607.50	5000 staples 10 mm	<input type="checkbox"/> 5	607504
607.55	1000 staples 10 mm	<input checked="" type="checkbox"/> 10	607559
607.60	5000 staples 12 mm	<input type="checkbox"/> 5	607603
607.65	1000 staples 12 mm	<input checked="" type="checkbox"/> 10	607658
607.70	5000 staples 14 mm	<input type="checkbox"/> 5	607702
607.75	1000 staples 14 mm	<input checked="" type="checkbox"/> 10	607757

 PG pack neutral pack

TAPE RULE MEASURE

Abs body, nylon metal tape with double stop and automatic rewind



611.10	3 m - 16 mm tape - €€	<input type="checkbox"/>	12	611105
611.20	5 m - 19 mm tape - €€	<input type="checkbox"/>	6	611204
611.30	8 m - 25 mm tape - €€	<input type="checkbox"/>	4	611303

**TAPE RULE MEASURES** in display box

611.25	12 tape rule measures 5 m art. 611.20 - €€	<input type="checkbox"/>	1	611259
---------------	---	--------------------------	---	--------

ref.

description

pack
q.tyEAN13
8011017**WOOD JOINTING****CARPENTER PENCIL**

649.00	180 mm	<input type="checkbox"/> 144	009407
649.06	6 pencils 180 mm	<input checked="" type="checkbox"/> 5	649061

**DOWELMATE DOWELLING KIT**

650.00	including 1 dowelling jig - 3 spacers - assorted wooden dowels \varnothing 6 - 8 - 10 mm	<input checked="" type="checkbox"/> 1	650005
---------------	---	---------------------------------------	--------

**WOODEN DOWELS**

655.00	100 wooden dowels \varnothing 6 x 30 mm	<input checked="" type="checkbox"/> 10	655000
655.05	1000 wooden dowels \varnothing 6 x 30 mm	<input type="checkbox"/> 1	655055
660.00	60 wooden dowels \varnothing 8 x 35 mm	<input checked="" type="checkbox"/> 10	660004
660.05	1000 wooden dowels \varnothing 8 x 35 mm	<input type="checkbox"/> 1	660059
665.00	40 wooden dowels \varnothing 10 x 40 mm	<input checked="" type="checkbox"/> 10	665009
665.05	1000 wooden dowels \varnothing 10 x 40 mm	<input type="checkbox"/> 1	665054
666.00	30 wooden dowels \varnothing 12 x 40 mm	<input checked="" type="checkbox"/> 10	666006
666.05	500 wooden dowels \varnothing 12 x 40 mm	<input type="checkbox"/> 1	666051

**EXTRA-LONG WOODEN DOWELS**

668.00	100 wooden dowels \varnothing 6 x 1000 mm	<input type="checkbox"/> 1	668000
668.10	100 wooden dowels \varnothing 8 x 1000 mm	<input type="checkbox"/> 1	668109
668.20	100 wooden dowels \varnothing 10 x 1000 mm	<input type="checkbox"/> 1	668208
668.30	50 wooden dowels \varnothing 12 x 1000 mm	<input type="checkbox"/> 1	668307
668.40	40 wooden dowels \varnothing 14 x 1000 mm	<input type="checkbox"/> 1	668406
668.50	40 wooden dowels \varnothing 16 x 1000 mm	<input type="checkbox"/> 1	668505

 PG pack neutral pack

WOODEN JOINTING BISCUITS

669.00	50 wooden biscuits type 0 - 48 x 16 x 4 mm	<input checked="" type="checkbox"/>	669007
669.05	1000 wooden biscuits type 0 - 48 x 16 x 4 mm	<input type="checkbox"/>	669052
669.10	50 wooden biscuits type 10 - 53 x 19 x 4 mm	<input checked="" type="checkbox"/>	669106
669.15	1000 wooden biscuits type 10 - 53 x 19 x 4 mm	<input type="checkbox"/>	669151
669.20	50 wooden biscuits type 20 - 61 x 24 x 4 mm	<input checked="" type="checkbox"/>	669205
669.25	1000 wooden biscuits type 20 - 61 x 24 x 4 mm	<input type="checkbox"/>	669250

DEPTH STOPS

620.00	3 depth stops \varnothing 6 - 8 - 10 mm	<input checked="" type="checkbox"/>	620008
620.10	1 depth stop \varnothing 12 mm	<input checked="" type="checkbox"/>	620107
620.20	1 depth stop \varnothing 14 mm	<input checked="" type="checkbox"/>	620206

CENTRE POINTS

670.00	4 centre points \varnothing 6 mm	<input checked="" type="checkbox"/>	670003
675.00	4 centre points \varnothing 8 mm	<input checked="" type="checkbox"/>	675008
680.00	4 centre points \varnothing 10 mm	<input checked="" type="checkbox"/>	680002
680.10	4 centre points \varnothing 12 mm	<input checked="" type="checkbox"/>	680101
680.20	2 centre points \varnothing 14 mm	<input checked="" type="checkbox"/>	680200

DOWELLING KITS

681.00	complete with drill \varnothing 6 mm - depth stop - 4 centre points - 25 wooden dowels \varnothing 6 mm	<input checked="" type="checkbox"/>	681009
682.00	complete with drill \varnothing 8 mm - depth stop - 4 centre points - 25 wooden dowels \varnothing 8 mm	<input checked="" type="checkbox"/>	682006
683.00	complete with drill \varnothing 10 mm - depth stop - 4 centre points - 20 wooden dowels \varnothing 10 mm	<input checked="" type="checkbox"/>	683003

ref.

description

pack
q.tyEAN13
8011017**JIGSAW BLADES****JIGSAW BLADES - BLACK & DECKER - SKIL FITTING****HSS - for metal**

684.00	3 blades - coarse cutting	10	684000
685.00	3 blades - medium cutting	10	685007
686.00	3 blades - fine cutting	10	686004
686.50	3 blades - medium cutting - 80 mm length	10	686509

HSS HIGH SPEED STEEL**CV - for wood**

687.00	3 blades - coarse cutting	10	687001
688.00	3 blades - medium cutting	10	688008
689.00	3 blades - fine cutting	10	689005
689.10	3 blades - coarse cutting - grounded blade	10	689104
689.20	3 blades - medium cutting - grounded blade	10	689203
689.50	3 blades - medium cutting - 100 mm length	10	689500
720.00	3 blades - medium cutting - for cutting curves	10	720005
720.50	2 blades - double edge teeth - 115 mm length - for extreme curved cuts	5	720500

CV CHROME VANADIUM**CV** CHROME VANADIUM**CV** CHROME VANADIUM**CV** CHROME VANADIUM**HARD METAL - for glass, tiles, bricks and plastic laminates**

724.00	1 blade	5	724003
---------------	---------	---	--------

HM HARD METAL**KIT 10 JIGSAW BLADES - BLACK & DECKER - SKIL FITTING**

720.90	3 CV blades coarse cutting for wood + 3 CV blades medium cutting for wood + 2 CV blades cutting curves for wood + 2 HSS blades fine cutting for metal	3	720906
---------------	---	---	--------

 PG pack neutral pack

JIGSAW BLADES - WIDE BOSCH FITTING

HSS - for metal

694.00	3 blades - coarse cutting	10	694009
695.00	3 blades - medium cutting	10	695006
696.00	3 blades - fine cutting	10	696003
696.50	3 blades - medium cutting - 80 mm length	10	696508

CV - for wood

697.00	3 blades - coarse cutting	10	697000
698.00	3 blades - medium cutting	10	698007
699.00	3 blades - fine cutting	10	699004
699.10	3 blades - coarse cutting - grounded blade	10	699103
699.20	3 blades - medium cutting - grounded blade	10	699202
699.50	3 blades - medium cutting - 100 mm length	10	699509
699.60	2 blades - medium cutting - 220 mm length - for insulating materials and styrofoam	10	087399
721.00	3 blades - medium cutting - for cutting curves	10	721002
721.50	2 blades - double edge teeth - 115 mm length - for extreme curved cuts	5	721507

HARD METAL - for glass, tiles, bricks and plastic laminates

725.00	1 blade	5	725000
---------------	----------------	----------	--------

KIT 10 JIGSAW BLADES - WIDE BOSCH FITTING

721.90	3 CV blades coarse cutting for wood + 3 CV blades medium cutting for wood + 2 CV blades cutting curves for wood + 2 HSS blades fine cutting for metal	3	721903
---------------	---	----------	--------

PG pack

neutral pack

ref.

description

pack
q.tyEAN13
8011017**JIGSAW BLADES****JIGSAW BLADES - MAKITA FITTING****HSS** - for metal

714.00	3 blades - coarse cutting	10	714004
715.00	3 blades - medium cutting	10	715001
716.00	3 blades - fine cutting	10	716008

HSS HIGH SPEED STEEL**CV** - for wood

717.00	3 blades - coarse cutting	10	717005
718.00	3 blades - medium cutting	10	718002
719.00	3 blades - fine cutting	10	719009
722.00	3 blades - medium cutting - for cutting curves	10	722009

CV CHROME VANADIUM**CV** CHROME VANADIUM**JIGSAW BLADES - NARROW BOSCH FITTING****HSS** - for metal

704.00	3 blades - coarse cutting	10	704005
705.00	3 blades - medium cutting	10	705002
706.00	3 blades - fine cutting	10	706009

HSS HIGH SPEED STEEL**CV** - for wood

707.00	3 blades - coarse cutting	10	707006
708.00	3 blades - medium cutting	10	708003

CV CHROME VANADIUM PG pack neutral pack

HOLE SAW

For wood, plasterboards, plastic



730.00	with 7 blades from \varnothing 25 mm to \varnothing 62 mm height 25 mm	<input type="checkbox"/>	10	730004
732.00	with 7 blades from \varnothing 25 mm to \varnothing 62 mm height 50 mm	<input type="checkbox"/>	10	732008
735.00	with 5 blades from \varnothing 60 mm to \varnothing 95 mm height 40 mm	<input type="checkbox"/>	5	735009

CIRCULAR TILE CUTTER

With pilot drill and carbide tipped cutter



217.00	from \varnothing 30 mm to \varnothing 100 mm - 450 RPM	<input type="checkbox"/>	1	217000
217.10	cutting tool for art. 217.00	<input type="checkbox"/>	1	217109

BIMETAL HOLE SAW ARBOR

13.780	\varnothing 14/30 mm - shank \varnothing 6,35 mm	<input type="checkbox"/>	1	137803
13.785	\varnothing 32/152 mm - shank \varnothing 6,35 mm	<input type="checkbox"/>	1	137858
13.790	\varnothing 14/30 mm - shank hex. 12 mm	<input type="checkbox"/>	1	137902
13.795	\varnothing 32/152 mm - shank hex. 12 mm	<input type="checkbox"/>	1	137957

REPLACEMENT DRILL FOR BIMETAL ARBOR

13.800	length 115 mm	<input type="checkbox"/>	1	138008
13.805	length 70 mm	<input type="checkbox"/>	1	138053

ref.

description

pack
q.tyEAN13
8011017**HOLE SAWS****BIMETAL HOLE SAW**

13.500	ø 14 mm	1	135007
13.505	ø 16 mm	1	135052
13.510	ø 17 mm	1	135106
13.515	ø 19 mm	1	135151
13.520	ø 20 mm	1	135205
13.525	ø 21 mm	1	135250
13.530	ø 22 mm	1	135304
13.535	ø 24 mm	1	135359
13.540	ø 25 mm	1	135403
13.545	ø 27 mm	1	135458
13.550	ø 29 mm	1	135502
13.555	ø 30 mm	1	135557
13.560	ø 32 mm	1	135601
13.565	ø 33 mm	1	135656
13.570	ø 35 mm	1	135700
13.575	ø 37 mm	1	135755
13.580	ø 38 mm	1	135809
13.585	ø 40 mm	1	135854
13.590	ø 41 mm	1	135908
13.595	ø 43 mm	1	135953
13.600	ø 44 mm	1	136004
13.605	ø 46 mm	1	136059
13.610	ø 48 mm	1	136103
13.615	ø 51 mm	1	136158
13.620	ø 52 mm	1	136202
13.625	ø 54 mm	1	136257
13.630	ø 57 mm	1	136301
13.635	ø 59 mm	1	136356
13.640	ø 60 mm	1	136400
13.645	ø 64 mm	1	136455
13.650	ø 65 mm	1	136509
13.655	ø 67 mm	1	136554
13.660	ø 70 mm	1	136608
13.665	ø 73 mm	1	136653
13.670	ø 76 mm	1	136707
13.675	ø 79 mm	1	136752
13.680	ø 83 mm	1	136806
13.685	ø 86 mm	1	136851
13.690	ø 89 mm	1	136905
13.695	ø 92 mm	1	136950
13.700	ø 95 mm	1	137001
13.705	ø 98 mm	1	137056
13.710	ø 102 mm	1	137100
13.715	ø 105 mm	1	137155
13.720	ø 108 mm	1	137209
13.725	ø 111 mm	1	137254
13.730	ø 114 mm	1	137308
13.735	ø 121 mm	1	137353
13.740	ø 127 mm	1	137407
13.745	ø 140 mm	1	137452
13.750	ø 152 mm	1	137506

 PG pack

 neutral pack



CV CIRCULAR SAW BLADE

ø mm		n. teeth	RPM	ref.	q.ty	EAN13 8011017
est.	bore					
125	20	24	7000	740.00	5	740003
125	20	80	7000	745.00	5	745008
150	20	24	7000	750.00	5	750002
150	20	80	7000	755.00	5	755007

With **2** bushes for adapting the bore: **20/13** mm and **20/16** mm



**CARBIDE TIPPED CIRCULAR SAW BLADE
ALTERNATE TEETH**

ø mm		n. teeth	suitable with:	RPM	ref.	q.ty	EAN13 8011017
est.	bore						
125	20	18	Bosch - Festo - Haffner - Hitachi - Mafell - Metabo - Ulmia	13000	756.02	1	756028
140	20	18	AEG - Bosch - Peugeot - Holz Her - Makita - Metabo - Stayer	13000	756.06	1	756066
150	20	20	AEG - B&D - Bosch - Elu - Fein - Hitachi - Kress - Mafell - Metabo - Peugeot - Scheer - Skil - Wegoma	13000	756.10	1	756103
150	30	36		13000	756.12	1	756127
160	20	24	AEG - B&D - Bosch - Einhell - Fein - Festo - Haffner - Hitachi - Holz Her - Kress - Mafell - Makita - Narex - Peugeot - Protool - Rockwell - Ryobi - Scheer - Skil - Ulmia	9500	756.14	1	756141
160	20	36		9500	756.16	1	756165
170	30	18	Bosch - Elu - Festo - Haffner - Hitachi - Holz Her - Mafell - Makita - Metabo - Skil	9500	756.18	1	756189
170	30	36		9500	756.20	1	756202
180	30	22	B&D - Bosch - Elu - Festo - Haffner - Hitachi - Holz Her - Mafell - Makita - Metabo - Peugeot - Ryobi - Skil	9500	756.22	1	756226
180	30	36		9500	756.24	1	756240
180	30	52		9500	756.26	1	756264
190	30	30	AEG - B&D - Bosch - DeWalt - Elu - Festo - Hitachi - Holz Her - Kress - Mafell - Makita - Metabo - Protool - Scheer - Skil - Stayer	9500	756.28	1	756288
190	30	42		9500	756.30	1	756301
200	30	42	AEG - B&D - Bosch - Festo - Haffner - Hanning - Holz Her - Kity - Mafell - Makita - Ryobi - Scheer - Ulmia	9500	756.32	1	756325
200	30	60		9500	756.34	1	756349
210	30	20	AEG - B&D - Bosch - Elektra Beckum - Elu - Fein - Haffner - Hitachi - Holz Her - Mafell - Makita - Metabo - Skil - Stayer	9500	756.36	1	756363
210	30	30		9500	756.38	1	756387
210	30	42		9500	756.40	1	756400
230	30	20	AEG - B&D - Bosch - Festo - Haffner - Holz Her - Mafell - Peugeot - Scheer - Skil - Stayer	9500	756.42	1	756424
230	30	34		9500	756.44	1	756448
230	30	40		9500	756.46	1	756462
250	30	24	Elektra Beckum - Elu - Mafell - Metabo	8000	756.48	1	756486
250	30	48		8000	756.50	1	756509
250	30	60		8000	756.52	1	756523
300	30	48	Elektra Beckum - Elu	4000	756.54	1	756547
300	30	72		4000	756.56	1	756561
300	30	96		4000	756.58	1	756585
350	30	84	Festo	4000	756.60	1	756608
350	30	108		4000	756.62	1	756622

ref.

description

pack
q.tyEAN13
8011017**CHUCKS****KEYLESS CHUCK**

Male threaded

760.00	3/8" x 24 - ø 10 mm for Black & Decker	1	760001
---------------	--	---	--------

**KEYLESS CHUCK**

Female threaded

762.00	3/8" x 24 - ø 10 mm for Skil, Metabo, Makita, Wolf	1	762005
764.00	3/8" x 24 - ø 13 mm for Skil, Metabo, Makita, Wolf	1	764009
766.00	1/2" x 20 - ø 10 mm for Atlas Copco, Bosch, Fein, Kress, Metabo	1	766003
768.00	1/2" x 20 - ø 13 mm for Atlas Copco, Bosch, Fein, Kress, Metabo	1	768007

**KEYLESS CHUCK for reversing power tools**

Male threaded

773.00	3/8" x 24 - ø 10 mm for Black & Decker	1	773001
---------------	--	---	--------

**KEYLESS CHUCK for reversing power tools**

Female threaded

774.00	3/8" x 24 - ø 10 mm for Skil, Metabo, Makita, Wolf	1	774008
774.50	3/8" x 24 - ø 13 mm for Skil, Metabo, Makita, Wolf	1	774503
775.00	1/2" x 20 - ø 10 mm for Atlas Copco, Bosch, Fein, Kress, Metabo	1	775005
775.50	1/2" x 20 - ø 13 mm - metal body - SUITABLE ALSO FOR HAMMER DRILLS for Atlas Copco, Bosch, Fein, Kress, Metabo	1	775500
775.60	1/2" x 20 - ø 13 mm for Atlas Copco, Bosch, Fein, Kress, Metabo	1	775609

**KEYLESS CHUCK**

SDS PLUS shank

775.51	ø 13 mm - metal body - SUITABLE ALSO FOR HAMMER DRILLS	1	775517
775.61	ø 13 mm	1	775616

 PG pack

 neutral pack

CHUCK WITH KEY

Male threaded



780.00	3/8" x 24 - ø 10 mm for Black & Decker	1	780009
781.00	3/8" x 24 - ø 13 mm for Black & Decker	1	781006

CHUCK WITH KEY

Female threaded



783.00	3/8" x 24 - ø 10 mm for Skil, Metabo, Makita, Wolf (38 mm)	1	783000
784.00	3/8" x 24 - ø 13 mm for Skil, Metabo, Makita, Wolf (38 mm)	1	784007
786.00	1/2" x 20 - ø 10 mm for Atlas Copco, Bosch, Fein, Kress, Metabo (43 mm)	1	786001
787.00	1/2" x 20 - ø 13 mm for Atlas Copco, Bosch, Fein, Kress, Metabo (43 mm)	1	787008

CHUCK WITH KEY

SDS PLUS shank



787.01	ø 13 mm	1	787015
---------------	----------------	----------	--------

CHUCK WITH KEY

Exagonal shank



788.00	ø 10 mm	1	788005
---------------	----------------	----------	--------

DRILL CHUCK

Exagonal shank



788.50	ø 0,5-6,5 mm	5	788500
---------------	---------------------	----------	--------

ref.

description

pack
q.tyEAN13
8011017**CHUCKS****CHUCK ADAPTOR**

789.00	SDS PLUS fitting 1/2" x 20	5	789002
789.10	M6 left hand locking screw for chucks	1	789101
789.50	male 3/8" - male 1/2"	1	789507
789.60	male 3/8" - male 3/8"	1	789606
789.70	male 1/2" - female 3/8"	1	789705

**DRILL CHUCK KEY**

790.00	10 mm - for Black & Decker	10	790008
791.00	13 mm - for Black & Decker	10	791005
792.00	13 mm - universal	10	792002
793.00	16 mm - universal	5	793009
794.00	universal	5	794006

**FLEXIBLE SHAFT**

550.00	90 cm length - chuck \varnothing 6 mm 4000 RPM - CE	1	550008
555.00	130 cm length - chuck \varnothing 8 mm professional model - 4000 RPM - CE	1	555003
560.00	130 cm length - chuck \varnothing 8 mm professional model with ball bearings - 8000 RPM - CE	1	560007

**REPLACEMENT CHUCK**

550.06	\varnothing 6 mm	1	550060
555.08	\varnothing 8 mm	1	555089



PG pack

neutral pack

MARKING PEN WITH CARBIDE TIP

598.50	marking pen to mark on metal, glass and tiles	5	598505
---------------	---	----------	--------

GLUE GUN

Nozzle with heat protection, drip block. Mechanical aid. Shockproof plastic casing. For bonding paper, plastic, wood, ceramic, textiles



599.00	20 W - with 2 glue sticks \varnothing 7 mm	1	599007
---------------	---	----------	--------

599.20	40 W - with 2 glue sticks \varnothing 11 mm	1	599205
---------------	--	----------	--------

HOT MELT GLUE STICKS

600.00	12 sticks \varnothing 7 mm - lenght 100 mm	10	600000
---------------	---	-----------	--------

600.20	12 sticks \varnothing 11 mm - lenght 100 mm	10	600208
---------------	--	-----------	--------

WET GRINDING WHEEL

880.00	\varnothing 100 x 20 x 16 mm for drills with \varnothing 43 mm collar - CE	1	880006
---------------	--	----------	--------

882.00	replacement grinding wheel \varnothing 100 x 20 x 16 mm for art. 880.00	1	882000
---------------	--	----------	--------

DRILL POWERED PUMP

890.00	shank \varnothing 8 mm - for pipes 1/2" - 2500 l/h 3000 RPM - CE	5	890005
---------------	--	----------	--------



ref.

description



pack
q.tyEAN13
8011017**TOOLS AND
ACCESSORIES****HAND DRILL**

921.00	ø 6 mm chuck plastic handle - with bit storage	5	921006
924.00	ø 8 mm chuck plastic handle - with bit storage	1	924007
928.00	ø 13 mm chuck two speeds - with support	1	928005

**REPLACEMENT CHUCK FOR HAND DRILL**

930.00	ø 6 mm	1	930008
932.00	ø 8 mm	1	932002
936.00	ø 13 mm	1	936000

**CV KEY WRENCHES**

946.00	8 key wrenches for hexagonal screws 1,5 - 2 - 2,5 - 3 - 4 - 5 - 5,5 - 6		10	946009
946.50	10 key wrenches for hexagonal screws 1,5 - 2 - 2,5 - 3 - 4 - 5 - 5,5 - 6 - 8 - 10		10	946504
947.00	8 key wrenches for Torx screws T9 - T10 - T15 - T20 - T25 - T27 - T30 - T40		10	947006

 PG pack neutral pack

CARPENTER CLAMP

948.00	max opening 150 mm	6	948003
948.10	max opening 200 mm	6	948102
948.20	max opening 250 mm	6	948201
948.30	max opening 300 mm	6	948300
948.40	max opening 400 mm	4	948409
948.50	max opening 500 mm	4	948508
948.60	max opening 600 mm	4	948607
948.65	max opening 700 mm	2	948652
948.70	max opening 800 mm	2	948706
948.80	max opening 1000 mm	2	948805
948.82	max opening 1200 mm	2	948829
948.84	max opening 1500 mm	2	948843
948.86	max opening 2000 mm	2	948867
948.88	max opening 2500 mm	2	948881
948.90	max opening 3000 mm	2	948904

ONE HAND CLAMP

948.93	max opening 150 mm	4	948935
948.95	max opening 300 mm	4	948959
948.97	max opening 450 mm	4	948973

ALUMINIUM "C" CLAMP

With quick adjustment and steel spindle

949.00	80 x 65 mm	1	949000
949.10	105 x 75 mm	1	949109
949.20	160 x 75 mm	1	949208

ref.

description

pack
q.tyEAN13
8011017**CLAMPING****CLAMP**

949.50	max opening 50 mm	5	949505
949.60	max opening 75 mm	5	949604
949.70	max opening 100 mm	5	949703

**CLAMP**

951.00	max opening 25 mm	10	951003
952.00	max opening 50 mm	10	952000
953.00	max opening 75 mm	10	953007



QUICK PRESS VICE in die-cast aluminium
with quick adjuster and steel jaws to clamp round material

954.00	max opening 70 mm	1	954004
---------------	--------------------------	---	--------

**MOBILE CLAMP**

955.00	mobile clamp for 90° corner joints saw guide for 45° and work bench vice	1	955001
---------------	---	---	--------

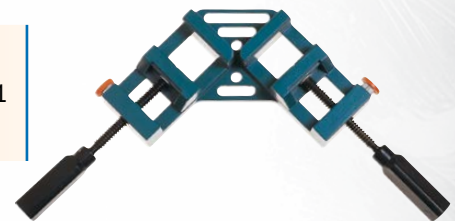
**CORNER CLAMP**

956.00	max opening 75 mm	5	956008
---------------	--------------------------	---	--------

 PG pack

 neutral pack



QUICK ADJUSTING BAND CLAMP

For gluing picture frames, furniture, shelves

957.00	4 m length	1	957005
---------------	------------	----------	--------



RATCHET CLAMP

957.50	max opening 50 mm	5	957500
---------------	--------------------------	----------	--------



RATCHET CLAMP

957.70	max opening 70 mm	5	957708
---------------	--------------------------	----------	--------



MINI SPRING CLAMPS

958.00	kit 4 mini spring clamps - max opening 18 mm	10	958002
---------------	--	-----------	--------

SPRING CLAMPS



958.05	max opening 30 mm	10	958057
958.07	max opening 40 mm	10	958071
958.10	max opening 60 mm	10	958101
958.14	max opening 70 mm	10	958149

ref.

description

pack
q.tyEAN13
8011017**DRILL STANDS****ROTARY DRILL CLAMP**

960.00	with collar \varnothing 43 mm	1	960005
---------------	---------------------------------	---	--------

**WOODTURNING LATHE ATTACHMENT**

965.00	adjustable distance between centers with collar \varnothing 43 mm	1	965000
---------------	--	---	--------

**MILL ATTACHMENT**

970.00	with collar \varnothing 43 mm	1	970004
---------------	---------------------------------	---	--------

**MOBILE DRILL STAND**

972.00	for drilling and hole-sawing, horizontally, vertically 0-45° - with collar \varnothing 43 mm	1	972008
---------------	--	---	--------

**UNIVERSAL ANGLE GRINDER STAND**

For cutting metal. Working surface with quick action clamping device

50.060	disc \varnothing 150/230 mm - vice jaw opening 113 mm - cast iron base 335 x 292 mm - professional model	1	500607
---------------	---	---	--------

50.080	disc \varnothing 150/230 mm - vice jaw opening 100 mm - sheet metal base 290 x 295 mm - DIY model	1	500805
---------------	--	---	--------

50.090	disc \varnothing 115/125 mm - vice jaw opening 77 mm - zamak base 240 x 190 mm - DIY model	1	500904
---------------	---	---	--------

 PG pack

 neutral pack

UNIVERSAL DRILL STAND

For precision and safety drilling. Working surface with clamping grooves for fastening clamping blocks or vices

50.010	with rotary collar \varnothing 43 mm - height 440 mm - stroke 65 mm - depth 99,5 mm - working height 260 mm - column \varnothing 22 mm - with return spring - aluminium base 250 x 180 mm - professional model	<input checked="" type="checkbox"/>	500102
50.020	with rotary collar \varnothing 43 mm - height 420 mm - stroke 60 mm - depth 96 mm - working height 240 mm - column \varnothing 22 mm - with return spring - aluminium base 220 x 175 mm - DIY model	<input checked="" type="checkbox"/>	500201
50.030	with rotary collar \varnothing 60 mm - with 3 reducing collars \varnothing 43-50-53 mm - height 500 mm - stroke 65 mm - depth 95 mm - working height 320 mm - column \varnothing 30 mm - with return spring - aluminium base 250 x 180 mm - professional model	<input checked="" type="checkbox"/>	500300
50.040	with rotary collar \varnothing 60 mm - with 3 reducing collars \varnothing 43-50-53 mm - height 500 mm - stroke 65 mm - depth 95 mm - working height 320 mm - column \varnothing 30 mm - with return spring - cast iron base 250 x 180 mm - professional model	<input checked="" type="checkbox"/>	500409

REDUCING COLLAR for drill stands

43.034	\varnothing 43 x 34 mm	<input checked="" type="checkbox"/>	430348
43.037	\varnothing 43 x 37 mm	<input checked="" type="checkbox"/>	430379
43.038	\varnothing 43 x 38 mm	<input checked="" type="checkbox"/>	430386
43.384	\varnothing 43 x 38,4 mm	<input checked="" type="checkbox"/>	433844
60.043	\varnothing 60 x 43 mm	<input checked="" type="checkbox"/>	600437
60.046	\varnothing 60 x 46 mm	<input checked="" type="checkbox"/>	600468
60.050	\varnothing 60 x 50 mm	<input checked="" type="checkbox"/>	600505
60.053	\varnothing 60 x 53 mm	<input checked="" type="checkbox"/>	600536
60.054	\varnothing 60 x 54 mm	<input checked="" type="checkbox"/>	600543
60.056	\varnothing 60 x 56 mm	<input checked="" type="checkbox"/>	600567



ref.

description

pack
q.tyEAN13
8011017**DRILLING****DUST CATCHER****565.00** for drill bits from \varnothing 4 mm to \varnothing 10 mm

10

565002

**TILE AND GLASS DRILL**

728.00	\varnothing 3 mm	5	728001
728.10	\varnothing 4 mm	5	728100
728.20	\varnothing 5 mm	5	728209
728.30	\varnothing 6 mm	5	728308
728.40	\varnothing 8 mm	5	728407
728.50	\varnothing 10 mm	5	728506
728.60	\varnothing 12 mm	5	728605

**TILE AND GLASS DRILL**Hexagonal shank **1/4"**

728.80	\varnothing 3 mm	5	728803
728.81	\varnothing 4 mm	5	728810
728.82	\varnothing 5 mm	5	728827
728.83	\varnothing 6 mm	5	728834
728.85	\varnothing 8 mm	5	728858
728.87	\varnothing 10 mm	5	728872
728.89	\varnothing 12 mm	5	728896

 PG pack

 neutral pack



HSS - DIN 338 HIGH SPEED STEEL TWIST DRILL

Hexagonal shank 1/4"

465.02	∅ 2 mm	<input checked="" type="checkbox"/>	465029
465.03	∅ 3 mm	<input checked="" type="checkbox"/>	465036
465.04	∅ 4 mm	<input checked="" type="checkbox"/>	465043
465.05	∅ 5 mm	<input checked="" type="checkbox"/>	465050



HSS - DIN 338 HIGH SPEED STEEL TWIST DRILL

∅ mm	PG BLISTER		BULK		q.ty
	ref.	EAN13 8011017	ref.	EAN13 8011017	
1	10.010 - 2 drills	100104	17.010	170107	10
1,5	10.015 - 2 drills	100159	17.015	170152	10
2	10.020 - 2 drills	100203	17.020	170206	10
2,5	10.025 - 2 drills	100258	17.025	170251	10
3	10.030 - 2 drills	100302	17.030	170305	10
3,5	10.035 - 2 drills	100357	17.035	170350	10
4	10.040 - 2 drills	100401	17.040	170404	10
4,5	10.045	100456	17.045	170459	10
5	10.050	100500	17.050	170503	10
5,5	10.055	100555	17.055	170558	10
6	10.060	100609	17.060	170602	10
6,5	10.065	100654	17.065	170657	10
7	10.070	100708	17.070	170701	10
7,5	10.075	100753	17.075	170756	10
8	10.080	100807	17.080	170800	10
8,5	10.085	100852	17.085	170855	10
9	10.090	100906	17.090	170909	10
9,5	10.095	100951	17.095	170954	10
10	10.100	101002	17.100	171005	10
10,5	10.105	101057	17.105	171050	10
11	10.110	101101	17.110	171104	10
11,5	10.115	101156	17.115	171159	10
12	10.120	101200	17.120	171203	10
12,5	10.125	101255	17.125	171258	10
13	10.130	101309	17.130	171302	10
13,5			17.135	171357	5
14			17.140	171401	5
14,5			17.145	171456	5
15			17.150	171500	5
15,5			17.155	171555	5
16			17.160	171609	5



MASONRY CARBIDE TIPPED PLATE DRILL - DIN 8039 - for marble, granite, cement, rock, concrete, bricks and tiles - rotopercussion use

ø mm	PG BLISTER		BULK		q.ty
	ref.	EAN13 8011017	ref.	EAN13 8011017	
3	15.030	150307	16.030	160306	10
4	15.040	150406	16.040	160405	10
5	15.050	150505	16.050	160504	10
5,5			16.055	160559	10
6	15.060	150604	16.060	160603	10
6,5			16.065	160658	10
7	15.070	150703	16.070	160702	10
8	15.080	150802	16.080	160801	10
9	15.090	150901	16.090	160900	10
10	15.100	151007	16.100	161006	10
11			16.110	161105	10
12	15.120	151205	16.120	161204	10
13			16.130	161303	10
14	15.140	151403	16.140	161402	10
15			16.150	161501	10
16			16.160	161600	10
18			16.180	161808	10
20			16.200	162003	10



MASONRY CARBIDE TIPPED PLATE DRILL - DIN 8039 - 400 mm length

ø mm	ref.	EAN13 8011017	q.ty
8	16.408	164083	1
10	16.410	164106	1
12	16.412	164120	1
14	16.414	164144	1
16	16.416	164168	1
18	16.418	164182	1
20	16.420	164205	1
22	16.422	164229	1
25	16.425	164250	1



MASONRY CARBIDE TIPPED PLATE DRILL - DIN 8039 - 600 mm length

ø mm	ref.	EAN13 8011017	q.ty
10	16.610	166100	1
12	16.612	166124	1
14	16.614	166148	1
16	16.616	166162	1
18	16.618	166186	1
20	16.620	166209	1

CV WOOD DRILL - DIN 7487



ø mm	PG BLISTER		BULK		q.ty
	ref.	EAN13 8011017	ref.	EAN13 8011017	
3	630.03	630038	14.003	140032	10
4	630.04	630045	14.004	140049	10
5	630.05	630052	14.005	140056	10
6	630.06	630069	14.006	140063	10
7	630.07	630076	14.007	140070	10
8	630.08	630083	14.008	140087	10
9	630.09	630090	14.009	140094	10
10	630.10	630106	14.010	140100	10
11	630.11	630113	14.011	140117	10
12	630.12	630120	14.012	140124	10
13	630.13	630137	14.013	140131	10
14	630.14	630144	14.014	140148	10
15			14.015	140155	10
16			14.016	140162	10
18			14.018	140186	5
20			14.020	140209	5
22			14.022	140223	5
24			14.024	140247	5
26			14.026	140261	2
28			14.028	140285	2
30			14.030	140308	2

CV WOOD DRILL - 250 mm length



ø mm	ref.	EAN13 8011017	q.ty
6	14.206	142067	10
7	14.207	142074	10
8	14.208	142081	10
9	14.209	142098	10
10	14.210	142104	10
11	14.211	142111	10
12	14.212	142128	10
13	14.213	142135	5
14	14.214	142142	5
15	14.215	142159	5
16	14.216	142166	5
18	14.218	142180	2
20	14.220	142203	2
22	14.222	142227	2
24	14.224	142241	2

DRILLS ASSORTMENT

15.606	5 WOOD drill bits ø 4 - 5 - 6 - 8 - 10 mm	2	156064
15.607	8 WOOD drill bits ø 3 - 4 - 5 - 6 - 7 - 8 - 9 - 10 mm	2	156071
15.608	5 MASONRY drill bits ø 4 - 5 - 6 - 8 - 10 mm	2	156088
15.610	8 MASONRY drill bits ø 3 - 4 - 5 - 6 - 7 - 8 - 9 - 10 mm	2	156101
15.615	13 HSS drill bits ø 1,5 - 2 - 2,5 - 3 - 3,3 - 3,5 - 4 - 4,2 - 4,5 - 5 - 5,5 - 6 - 6,5 mm	2	156156
15.620	13 HSS drill bits ø 2 - 2,5 - 3 - 3,5 - 4 - 4,5 - 5 - 5,5 - 6 - 6,5 - 7 - 7,5 - 8 mm	2	156200
15.630	9 MASONRY - HSS drill bits HSS ø 3 - 4 - 5 - 6 - 8 mm MASONRY ø 4 - 5 - 6 - 8 mm	2	156309
15.640	9 WOOD - MASONRY - HSS drill bits ø 5 - 6 - 8 mm	2	156408



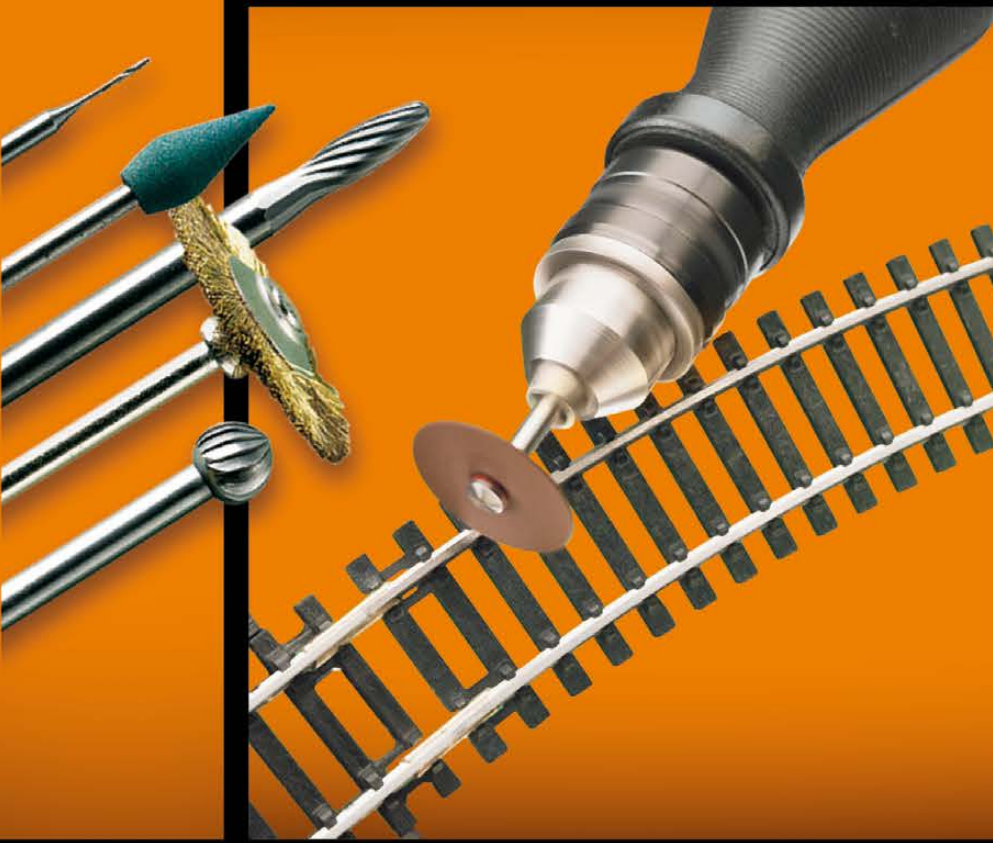

CARVING ENGRAVING MILLING



GRINDING SHARPENING



SANDING



CLEANING POLISHING



CUTTING ROUGHING



HSS DRILL BITS



ACCESSORIES



TOOLS TRANSFORMERS KITS



mini

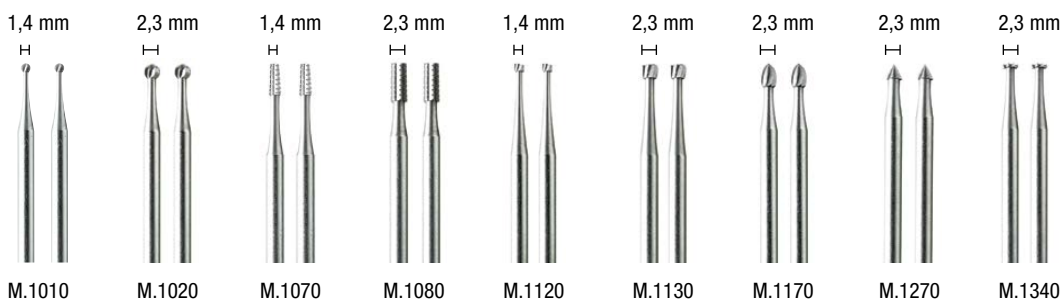

STEEL ENGRAVING CUTTERS

For carving, engraving and routing on wood, fiberglass, soft metal, plaster and plastic

M.1010	2 engraving cutters \varnothing 1,4 mm ball - shank \varnothing 2,35 mm	5	090009
M.1020	2 engraving cutters \varnothing 2,3 mm ball - shank \varnothing 2,35 mm	5	090016
M.1070	2 engraving cutters \varnothing 1,4 mm cylindrical - shank \varnothing 2,35 mm	5	090023
M.1080	2 engraving cutters \varnothing 2,3 mm cylindrical - shank \varnothing 2,35 mm	5	090030
M.1120	2 engraving cutters \varnothing 1,4 mm reverse taper - shank \varnothing 2,35 mm	5	090047
M.1130	2 engraving cutters \varnothing 2,3 mm reverse taper - shank \varnothing 2,35 mm	5	090054
M.1170	2 engraving cutters \varnothing 2,3 mm flame - shank \varnothing 2,35 mm	5	090061
M.1270	2 engraving cutters \varnothing 2,3 mm countersink - shank \varnothing 2,35 mm	5	090078
M.1340	2 engraving cutters \varnothing 2,3 mm wheel - shank \varnothing 2,35 mm	5	090085



STEEL CUTTERS

For carving, engraving, milling, slotting and countersinking on wood, fiberglass, soft metal, plaster and plastic

M.1030	\varnothing 4,0 mm ball - shank \varnothing 2,35 mm	5	090092
M.1050	\varnothing 6,0 mm ball - shank \varnothing 3,0 mm	5	090108
M.1065	\varnothing 7,8 mm oval - shank \varnothing 3,20 mm	5	092928
M.1100	\varnothing 6,0 mm cylindrical - shank \varnothing 3,0 mm	5	090115
M.1105	\varnothing 7,8 mm cylindrical - shank \varnothing 3,20 mm	5	092935
M.1140	\varnothing 4,0 mm reverse taper - shank \varnothing 2,35 mm	5	090122
M.1190	\varnothing 4,0 mm flame - shank \varnothing 2,35 mm	5	090139
M.1240	\varnothing 6,0 mm cone - shank \varnothing 3,0 mm	5	090146
M.1310	\varnothing 6,0 mm point - shank \varnothing 3,0 mm	5	090153
M.1370	\varnothing 6,0 mm wheel - shank \varnothing 3,0 mm	5	090160
M.1375	\varnothing 9,5 mm wheel - shank \varnothing 3,20 mm	5	092942

ref.

description

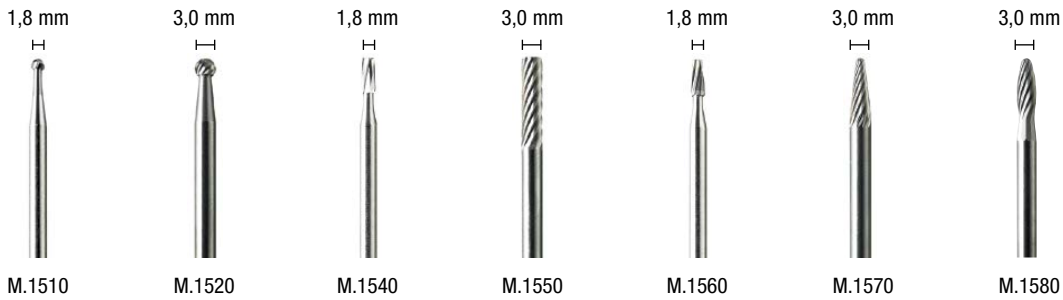
pack
q.tyEAN13
8011017**CARVING
ENGRAVING
MILLING****TUNGSTEN CARBIDE CUTTERS**

For material removal, smoothing and shaping. Particularly indicated for hardened and stainless steel, cast iron, non-ferrous metal, fired ceramic, wood, plastic and other hard materials

M.1510	∅ 1,8 mm ball - shank ∅ 2,35 mm	5	090177
M.1520	∅ 3,0 mm ball - shank ∅ 3,0 mm	5	090184
M.1540	∅ 1,8 mm cylindrical - shank ∅ 2,35 mm	5	090191
M.1550	∅ 3,0 mm cylindrical - shank ∅ 3,0 mm	5	090207
M.1560	∅ 1,8 mm cone - shank ∅ 2,35 mm	5	090214
M.1570	∅ 3,0 mm cone - shank ∅ 3,0 mm	5	090221
M.1580	∅ 3,0 mm flame - shank ∅ 3,0 mm	5	090238

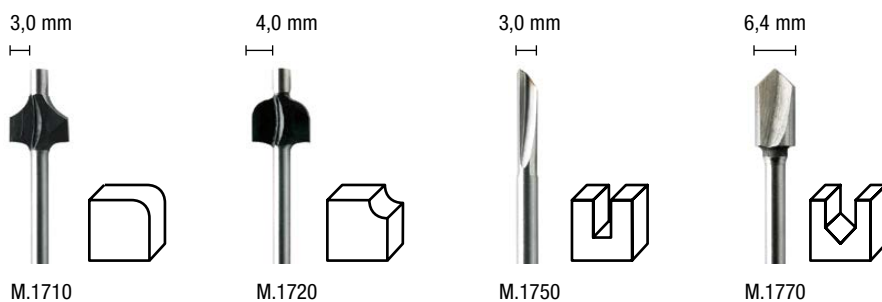
**HSS ROUTER BITS**

For finishing wooden edges and for different kinds of grooves and profiles

M.1710	r = 3,0 mm convex profiles - shank ∅ 3,0 mm	2	090320
M.1720	r = 4,0 mm concave profiles - shank ∅ 3,0 mm	2	090337
M.1750	∅ 3,0 mm straight grooves - shank ∅ 3,0 mm	2	090344
M.1770	∅ 6,4 mm V grooves - shank ∅ 3,0 mm	2	090351



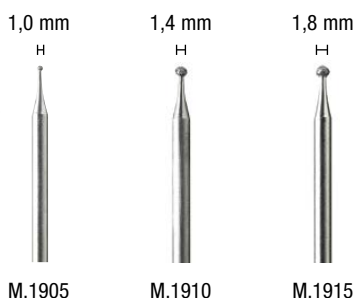

DIAMOND POINTS

Coated with diamond particles, especially indicated for fine detail works like engraving, carving, or finishing materials like glass, ceramic, semi-precious stones, metal, wood and other hard materials

M.1905	ø 1,0 ball - shank ø 2,35 mm	5	090245
M.1910	ø 1,4 ball - shank ø 2,35 mm	5	090252
M.1915	ø 1,8 ball - shank ø 2,35 mm	5	090269

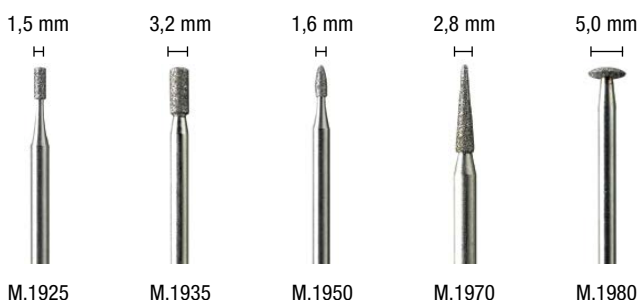

DIAMOND POINTS

Coated with diamond particles, especially indicated for fine detail works like engraving, carving, or finishing materials like glass, ceramic, semi-precious stones, metal, wood and other hard materials

M.1925	ø 1,5 cylindrical - shank ø 2,35 mm	5	090276
M.1935	ø 3,2 cylindrical - shank ø 2,35 mm	5	090283
M.1950	ø 1,6 flame - shank ø 2,35 mm	5	090290
M.1970	ø 2,8 point - shank ø 2,35 mm	5	090306
M.1980	ø 5,0 disc - shank ø 2,35 mm	5	090313

ref.

description

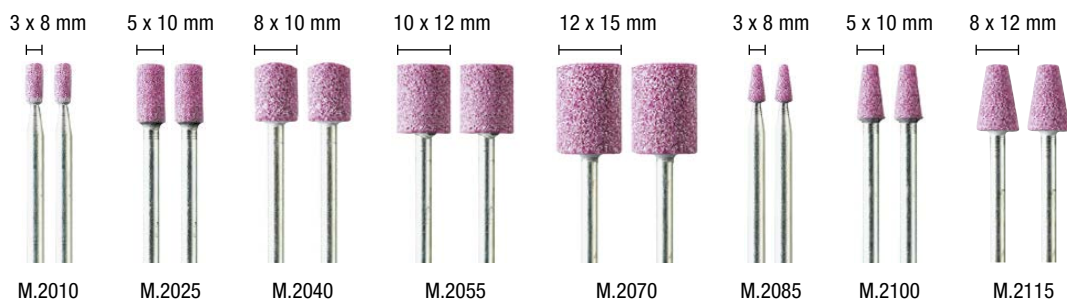
pack
q.tyEAN13
8011017**GRINDING
SHARPENING****RUBY GRINDING STONES**

High abrasive power. For sharpening, deburring and general grinding of most materials. Particularly indicated for precision grinding

M.2010	2 grinding stones \varnothing 3 x 8 mm - cylindrical - shank \varnothing 3,0 mm	5	090368
M.2025	2 grinding stones \varnothing 5 x 10 mm - cylindrical - shank \varnothing 3,0 mm	5	090375
M.2040	2 grinding stones \varnothing 8 x 10 mm - cylindrical - shank \varnothing 3,0 mm	5	090382
M.2055	2 grinding stones \varnothing 10 x 12 mm - cylindrical - shank \varnothing 3,0 mm	5	090399
M.2070	2 grinding stones \varnothing 12 x 15 mm - cylindrical - shank \varnothing 3,0 mm	5	090405
M.2085	2 grinding stones \varnothing 3 x 8 mm - cone - shank \varnothing 2,35 mm	5	090412
M.2100	2 grinding stones \varnothing 5 x 10 mm - cone - shank \varnothing 2,35 mm	5	090429
M.2115	2 grinding stones \varnothing 8 x 12 mm - cone - shank \varnothing 3,0 mm	5	090436

**RUBY GRINDING STONES**

High abrasive power. For sharpening, deburring and general grinding of most materials. Particularly indicated for precision grinding

M.2130	2 grinding stones \varnothing 6 x 10 mm - bullet - shank \varnothing 3,0 mm	5	090443
M.2145	2 grinding stones \varnothing 10 x 20 mm - bullet - shank \varnothing 3,0 mm	5	090450
M.2160	2 grinding stones \varnothing 6 mm - ball - shank \varnothing 3,0 mm	5	090467
M.2175	2 grinding stones \varnothing 10 mm - ball - shank \varnothing 3,0 mm	5	090474
M.2190	2 grinding stones \varnothing 6 x 12 mm - cylin./cone - shank \varnothing 3,0 mm	5	090481
M.2205	2 grinding stones \varnothing 8 x 15 mm - cylin./cone - shank \varnothing 3,0 mm	5	090498
M.2220	2 grinding stones \varnothing 10 x 20 mm - cylin./cone - shank \varnothing 3,0 mm	5	090504
M.2235	2 grinding stones \varnothing 8 x 6 mm - reverse taper - shank \varnothing 3,0 mm	5	090511





SILICON CARBIDE GRINDING STONES

Very high abrasive power. For sharpening hard metal tools and for finishing and precision works. For engraving and working stone, glass, crystals, ceramic and porcelain

M.2410	2 grinding stones ø 3 x 8 mm - cone - shank ø 2,35 mm	5	090528
M.2420	2 grinding stones ø 5 x 10 mm - cone - shank ø 2,35 mm	5	090535
M.2435	2 grinding stones ø 4 mm - ball - shank ø 3,0 mm	5	090542
M.2450	2 grinding stones ø 8 x 6 mm - reverse taper - shank ø 3,0 mm	5	090559
M.2465	2 grinding stones ø 6 x 10 mm - round head - shank ø 3,0 mm	5	090566
M.2480	2 grinding stones ø 5 x 10 mm - flame - shank ø 3,0 mm	5	090573

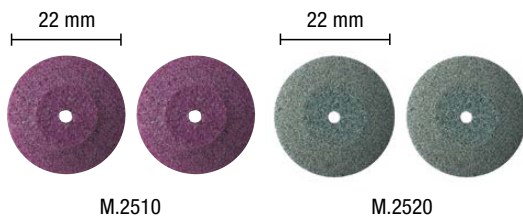

LENTICULAR GRINDING STONES

M.2510	2 grinding stones ø 22 mm - ruby abrasive	5	090580
M.2520	2 grinding stones ø 22 mm - silicon carbide	5	090597

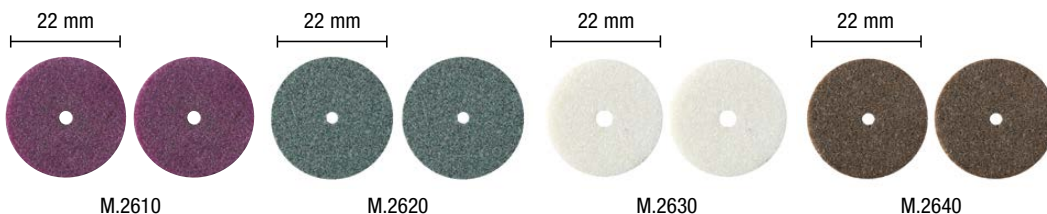

WHEEL GRINDING STONES

M.2610	2 grinding stones ø 22 mm - ruby abrasive	5	090603
M.2620	2 grinding stones ø 22 mm - silicon carbide	5	090610
M.2630	2 grinding stones ø 22 mm - white abrasive	5	090627
M.2640	2 grinding stones ø 22 mm - brown abrasive	5	090634

ref.

description

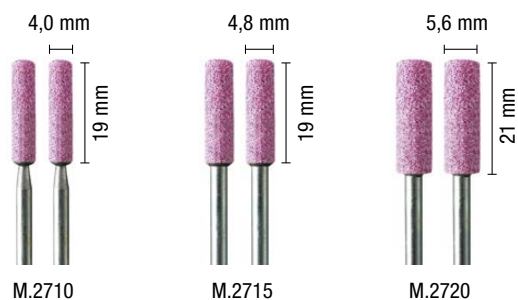
pack
q.tyEAN13
8011017**GRINDING
SHARPENING****CHAIN SAW RUBY SHARPENING STONES**

High abrasive power. For sharpening of chain saw blades

M.2710	2 grinding stones 4,0 x 19 mm - cylindrical - shank ø 3,0 mm	5	090641
M.2715	2 grinding stones 4,8 x 19 mm - cylindrical - shank ø 3,0 mm	5	090658
M.2720	2 grinding stones 5,6 x 21 mm - cylindrical - shank ø 3,0 mm	5	090665

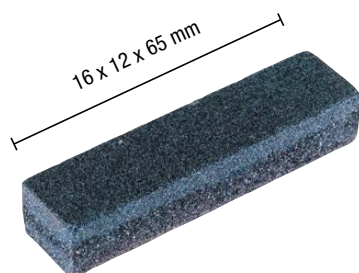

M.2910

STONE DRESSER

For restoring, cleaning and reshaping of grinding stones

M.2910	16 x 12 x 65 mm - double grain	5	090672
---------------	---------------------------------------	---	--------





FLAP GRINDING WHEELS

For grinding and polishing of metal, rubber and plastic flat and contoured surfaces and for rust removal

M.3020	ø 20 x 5 mm - grain 80 - shank ø 3,0 mm	5	090689
M.3030	ø 30 x 10 mm - grain 80 - shank ø 3,0 mm	5	090696

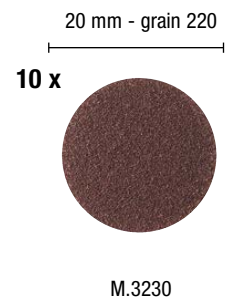
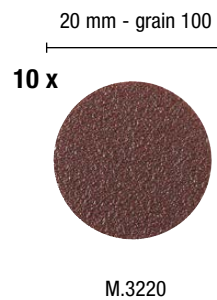
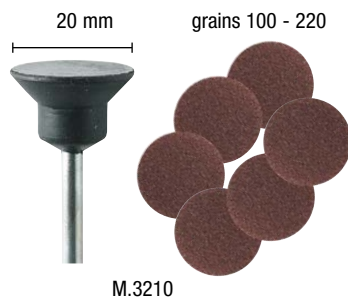

RUBBER BACKING PAD AND ADHESIVE SANDING DISCS

For sanding, grinding, shaping wood, plastic, rubber and removing rust from metal surfaces

M.3210	rubber backing pad ø 20 mm - shank ø 3,2 mm - 6 abrasive discs - assorted grades	5	090702
M.3220	10 abrasive discs ø 20 mm - grain 100	5	090719
M.3230	10 abrasive discs ø 20 mm - grain 220	5	090726

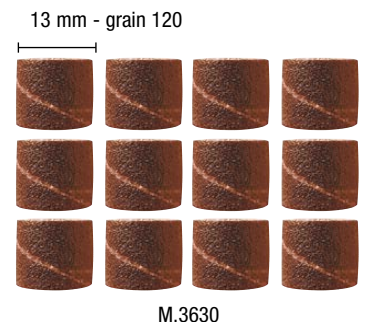
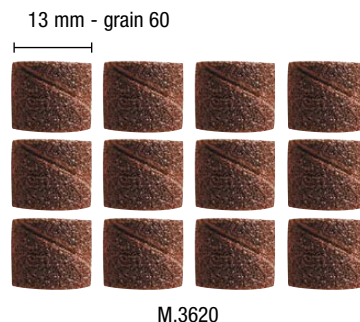

SANDING DRUM MANDREL AND SANDING BELTS

For sanding, grinding, shaping wood, plastic, rubber and removing rust from metal surfaces

M.3610	sanding drum mandrel ø 13 x 13 mm - shank ø 3,2 mm	5	090733
M.3620	12 sanding belts ø 13 mm - grain 60	5	090740
M.3630	12 sanding belts ø 13 mm - grain 120	5	090757

ref.

description

pack
q.tyEAN13
8011017**SANDING**

M.3640

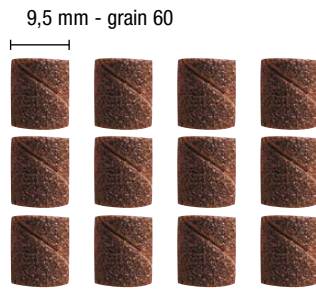

M.3650

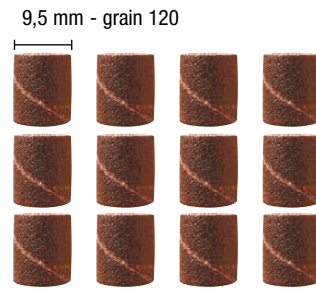

M.3660

**SANDING DRUM MANDREL AND SANDING BELTS**

For sanding, grinding, shaping wood, plastic, rubber and removing rust from metal surfaces

M.3640	sanding drum mandrel \varnothing 9,5 x 13 mm - shank \varnothing 3,2 mm	5	092959
M.3650	12 sanding belts \varnothing 9,5 mm - grain 60	5	092966
M.3660	12 sanding belts \varnothing 9,5 mm - grain 120	5	092973

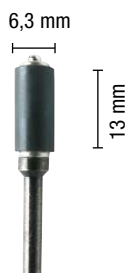

M.3670

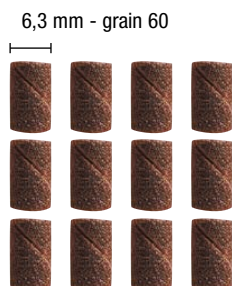

M.3680

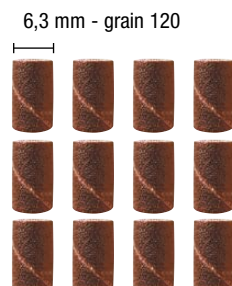

M.3690

**SANDING DRUM MANDREL AND SANDING BELTS**

For sanding, grinding, shaping wood, plastic, rubber and removing rust from metal surfaces

M.3670	sanding drum mandrel \varnothing 6,3 x 13 mm - shank \varnothing 3,2 mm	5	092980
M.3680	12 sanding belts \varnothing 6,3 mm - grain 60	5	092997
M.3690	12 sanding belts \varnothing 6,3 mm - grain 120	5	093000



STEEL BRUSHES: for cleaning and deburring metal, wood and plastic, for removing rust and corrosion and cleaning welding connections

BRASS BRUSHES: for cleaning, deburring and polishing wood, soft metals like gold, copper and brass without scratching and for cleaning electric components

M.4005	ø 5 mm - steel end brush - shank ø 2,35 mm	5	090764
M.4010	ø 12 mm - steel cup brush - shank ø 2,35 mm	5	090771
M.4015	ø 21 mm - steel wheel brush - shank ø 2,35 mm	5	090788
M.4020	3 assorted steel brushes	5	090795
M.4055	ø 5 mm - brass end brush - shank ø 2,35 mm	5	090801
M.4060	ø 12 mm - brass cup brush - shank ø 2,35 mm	5	090818
M.4065	ø 21 mm - brass wheel brush - shank ø 2,35 mm	5	090825
M.4070	3 assorted brass brushes	5	090832



BLACK BRISTLE BRUSHES: for light deburring, cleaning and polishing. Particularly indicated for silverware, jewelry and other precious materials

WHITE NYLON BRUSHES: for cleaning and polishing precious metals and other delicate surfaces

M.4105	ø 5 mm - black bristle end brush - shank ø 2,35 mm	5	090849
M.4110	ø 12 mm - black bristle cup brush - shank ø 2,35 mm	5	090856
M.4115	ø 21 mm - black bristle wheel brush - shank ø 2,35 mm	5	090863
M.4120	3 assorted black bristle brushes	5	090870
M.4155	ø 5 mm - white nylon end brush - shank ø 2,35 mm	5	090887
M.4160	ø 12 mm - white nylon cup brush - shank ø 2,35 mm	5	090894
M.4165	ø 21 mm - white nylon wheel brush - shank ø 2,35 mm	5	090900
M.4170	3 assorted white nylon brushes	5	090917

ref.

description

pack
q.tyEAN13
8011017**CLEANING
POLISHING****SILICON POLISHERS**

For polishing porcelain, ceramic, precious metals and enamels

M.4305	∅ 12 mm - disc - shank ∅ 2,35 mm	5	090924
M.4310	∅ 12 mm - lenticular - shank ∅ 2,35 mm	5	090931

**RUBBER POLISHING POINTS**

For finishing and polishing all ferrous metals, removing of scratches and imperfections and cleaning of carving on ceramic, ferrous materials and most stones

M.4505	∅ 6,0 mm - flame - shank ∅ 3,0 mm	5	090948
M.4510	∅ 5,0 mm - bullet - shank ∅ 3,0 mm	5	090955
M.4515	∅ 6,0 mm - cylindrical - shank ∅ 3,0 mm	5	090962

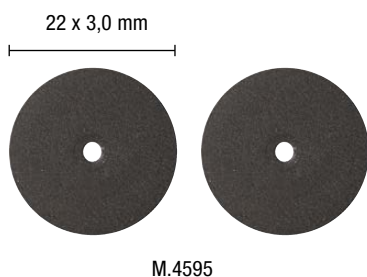
**BROWN RUBBER POLISHING DISC**

For polishing and removing scratches on ferrous materials, stones and ceramics

M.4595	2 discs ∅ 22 x 3,0 mm	5	090979
---------------	-----------------------	---	--------



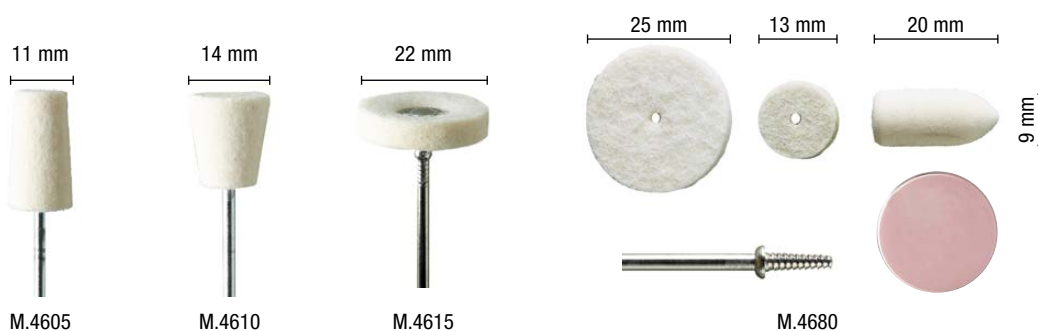

FELT DISCS

For polishing metal, glass, ceramics, marbles, precious metals, stones and plastic

M.4605	ø 11 mm - taper - shank ø 2,35 mm	5	090986
M.4610	ø 14 mm - reverse taper - shank ø 2,35 mm	5	090993
M.4615	ø 22 mm - wheel - shank ø 2,35 mm	5	091006
M.4680	kit 3 assorted felt points + mandrel + polishing paste	5	091013

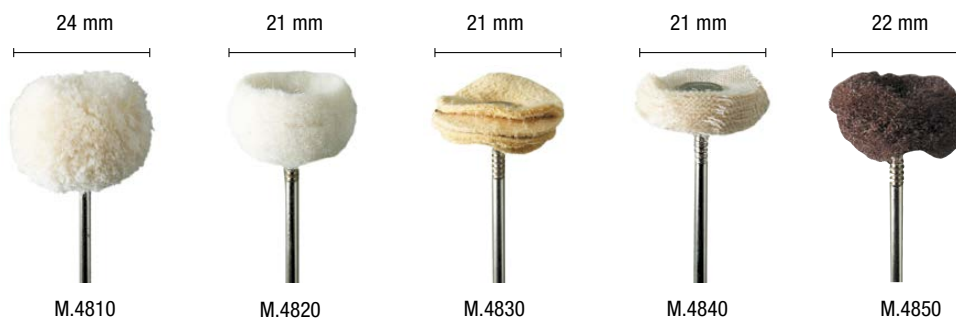

COTTON, SOFT FELT, CHAMOIS, AND COTTON FOLDS DISCS: for polishing metals, gold, silver, non-ferrous metals, brass, aluminium, glass

ABRASIVE DISC "SCOTCH FABRIC": for cleaning and light sanding of steel, stainless steel and other metals, glass, wood, aluminium and plastic

M.4810	ø 24 mm - cotton yarn disc - shank ø 2,35 mm	5	091020
M.4820	ø 21 mm - soft felt disc - shank ø 2,35 mm	5	091037
M.4830	ø 21 mm - chamois disc - shank ø 2,35 mm	5	091044
M.4840	ø 21 mm - cotton folds disc - shank ø 2,35 mm	5	091051
M.4850	ø 22 mm - abrasive disc "scotch fabric" - shank ø 2,35 mm	5	091068



POLISHING PASTE

To be used with felt or cotton accessories. For polishing metals and plastic and removing dullness and oxidations and light surface imperfections

M.4905	pink pre-polishing paste - universal	5	091075
M.4910	white final polishing paste - universal	5	091082
M.4915	red lapping paste for copper, brass, bronze	5	091099



ref.

description

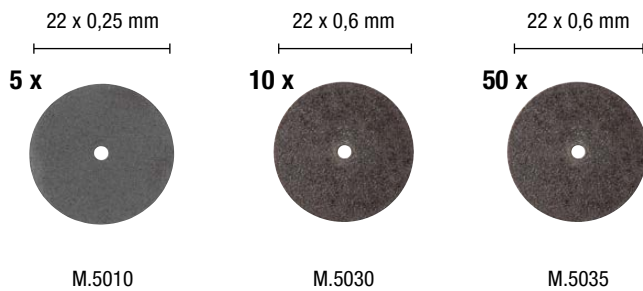
pack
q.tyEAN13
8011017**CUTTING
ROUGHING****CUTTING DISCS****M.5010** For cutting and grooving glass. Suitable also for metal plates, wood and plastic**M.5030 - M.5035** For cutting and slotting bolts, screws, metal plates, thin wood and plastic

M.5010	5 discs ø 22 x 0,25 mm - slim	5	091105
M.5030	10 discs ø 22 x 0,6 mm	5	091112
M.5035	50 discs ø 22 x 0,6 mm	5	091129

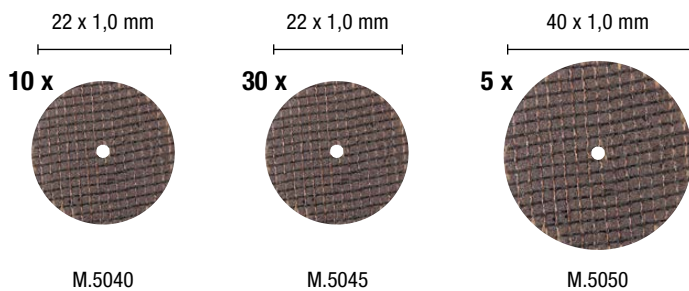
**FIBERGLASS REINFORCED CUTTING DISCS**

For cutting and slotting bolts, screws, metal plates, thin wood and plastic

M.5040	10 discs ø 22 x 1,0 mm	5	093680
M.5045	30 discs ø 22 x 1,0 mm	5	093697
M.5050	5 discs ø 40 x 1,0 mm	5	091136

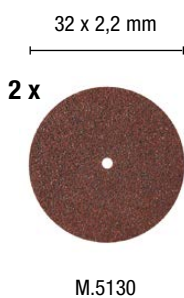
**ROUGHING DISCS**

For roughing and slotting metal, ceramic and plastic

M.5130	2 discs ø 32 x 2,2 mm	5	091143
---------------	-----------------------	---	--------



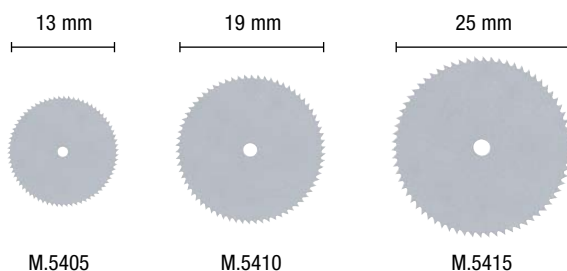

MINI STEEL SAW BLADES

For cutting plastic (electronic boards), wood and non ferrous metals

M.5405	∅ 13 mm	5	091150
M.5410	∅ 19 mm	5	091167
M.5415	∅ 25 mm	5	091174

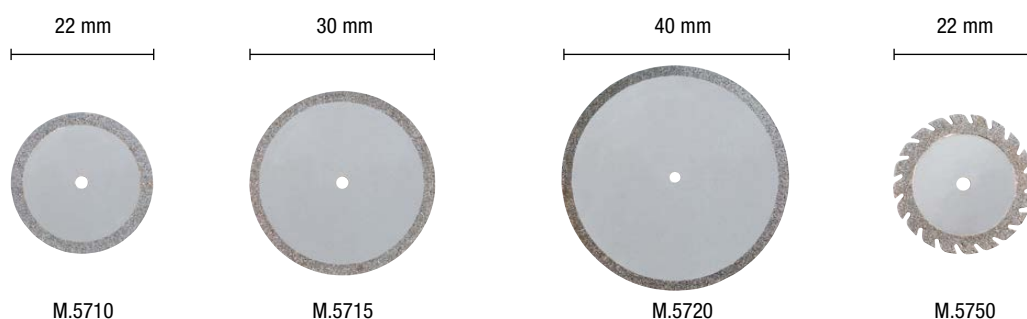

DIAMOND DISC

For cutting and grinding materials harder than metal, like marble, stone, porcelain, ceramic and hard resins. It allows an extreme precision while cutting and a long life

M.5710	∅ 22 mm	5	091181
M.5715	∅ 30 mm	5	093314
M.5720	∅ 40 mm	5	093321
M.5750	∅ 22 mm - segmented	5	093338

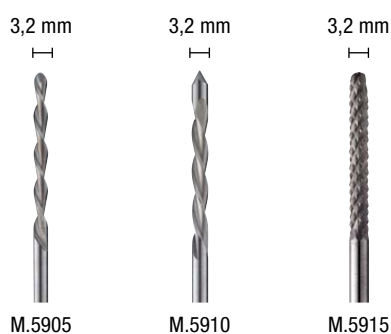

SPIRAL CUTTING BITS

M.5905 For cutting wood, plastic and fiberglass

M.5910 For cutting drywall

M.5915 For cutting ceramic tile, plaster and cement board

M.5905	∅ 3,2 mm - shank ∅ 3,2 mm	5	093345
M.5910	∅ 3,2 mm - shank ∅ 3,2 mm	5	093352
M.5915	∅ 3,2 mm - shank ∅ 3,2 mm	5	093369

ref.

description

pack
q.tyEAN13
8011017**HSS DRILL BITS**

A complete range of HSS drill bits to hole with precision wood, metal and plastic

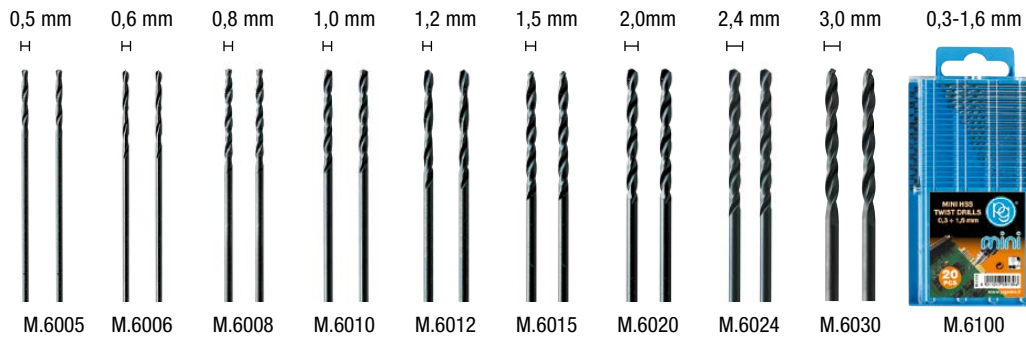
**HSS DRILL BITS**

M.6005	2 drill bits \varnothing 0,5 mm	5	091198
M.6006	2 drill bits \varnothing 0,6 mm	5	091204
M.6008	2 drill bits \varnothing 0,8 mm	5	091211
M.6010	2 drill bits \varnothing 1,0 mm	5	091228
M.6012	2 drill bits \varnothing 1,2 mm	5	091235
M.6015	2 drill bits \varnothing 1,5 mm	5	091242
M.6020	2 drill bits \varnothing 2,0 mm	5	091259
M.6024	2 drill bits \varnothing 2,4 mm	5	091266
M.6030	2 drill bits \varnothing 3,0 mm	5	091273
M.6100	kit 20 drill bits \varnothing 0,3 - 0,35 - 0,4 - 0,45 - 0,5 - 0,55 - 0,6 - 0,65 - 0,7 - 0,75 - 0,8 - 0,85 - 0,9 - 0,95 - 1,0 - 1,2 - 1,3 - 1,4 - 1,5 - 1,6 mm	2	091396

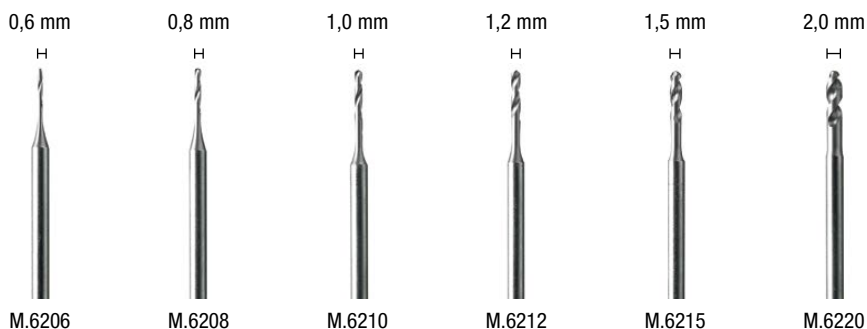
**HSS REINFORCED DRILL BITS**

M.6206	\varnothing 0,6 mm - shank \varnothing 2,35 mm	5	091280
M.6208	\varnothing 0,8 mm - shank \varnothing 2,35 mm	5	091297
M.6210	\varnothing 1,0 mm - shank \varnothing 2,35 mm	5	091303
M.6212	\varnothing 1,2 mm - shank \varnothing 2,35 mm	5	091310
M.6215	\varnothing 1,5 mm - shank \varnothing 2,35 mm	5	091327
M.6220	\varnothing 2,0 mm - shank \varnothing 2,35 mm	5	091334



1,0 mm 1,5 mm 2,35 mm 3,0 mm 3,2 mm



M.8010 (Minicraft, PG Mini, Proxxon)

0,8 mm 2,35 mm 3,0 mm 3,2 mm



M.8020 (B&D, Dremel)

COLLETS

M.8010	collets set \varnothing 1,0 - 1,5 - 2,35 - 3,0 - 3,2 mm and collet nut	2	093017
M.8020	collets set \varnothing 0,8 - 2,35 - 3,0 - 3,2 mm and collet nut	2	093024



M.8100



M.8110



M.8120

MANDRELS

M.8100	screw mandrel - shank \varnothing 3,0 mm	5	091358
M.8110	screw reinforced mandrel - shank \varnothing 2,35 mm	5	091365
M.8120	pyramidal mandrel - shank \varnothing 3,0 mm	5	091372



CABLE

M.8305	extension cable 5 m	1	091402
---------------	---------------------	---	--------

ref.

description

pack
q.ty

EAN13
8011017

ACCESSORIES

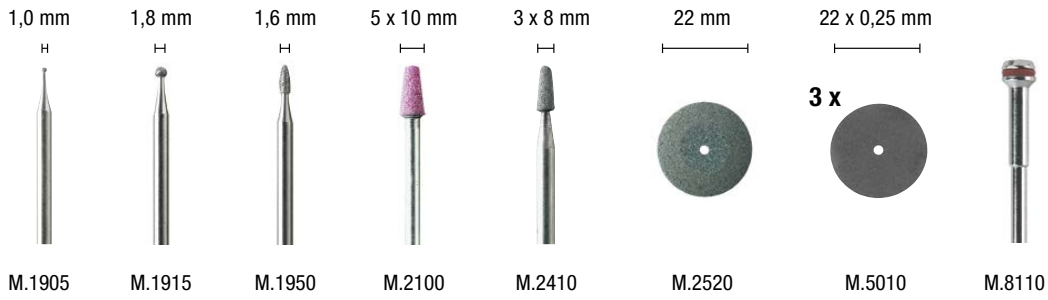

M.8210

M.8210 kit 10 accessories for engraving

2

093031



M.8230

M.8230 kit 10 accessories for grinding and sharpening

2

093048

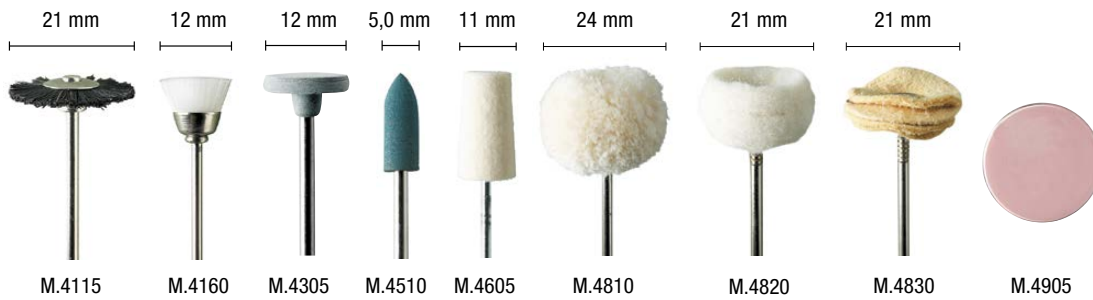

M.8250

M.8250 kit 9 accessories for cleaning and polishing

2

093055

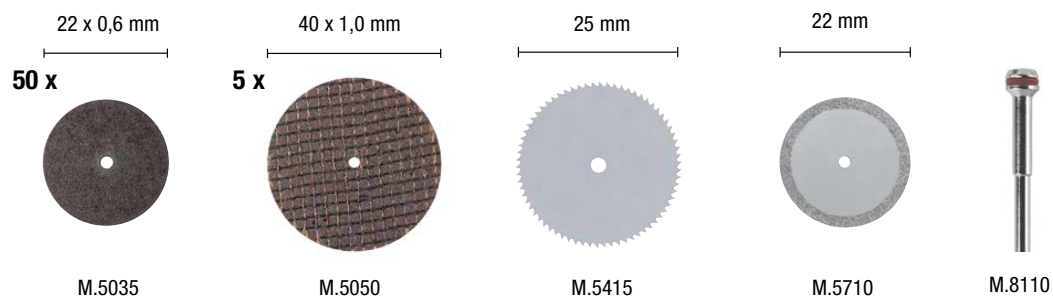

M.8270

M.8270 kit 58 accessories for cutting

2

093062





FLEXIBLE DRIVE SHAFT ideal for close up and detailed work

M.8500	- 80 cm length - with 3 assorted collets (ø 2,35 - 3,0 - 3,2 mm) and 1 nut - 30.000 RPM	1	091426
---------------	--	---	--------



0,4-3,2 mm



M.8550 (Minicraft, PG Mini, Proxon)

0,4-3,2 mm



M.8560 (B&D, Dremel)

0,4-6,0 mm



M.8580 (M.9400, M.9500, M.9600)

CHUCKS

M.8550	keyless chuck ø 0,4-3,2 mm - thread 8 x 0,75 - 10.000 RPM	1	091389
M.8560	keyless chuck ø 0,4-3,2 mm - thread 9/32" x 40 - 10.000 RPM	1	093376
M.8580	chuck with key and adaptor - ø 0,4-6,0 mm - thread 8 x 0,75 - 10.000 RPM	1	093598



MINI STORAGE CASE FOR ACCESSORIES

M.BOX01	- modular - in plastic anti-shock with anti-slip reinforcements - dimensions 16,5 x 12 x 6,5 cm	1	088228
----------------	--	---	--------

ref.

description

pack
q.tyEAN13
8011017**ACCESSORIES**

M.8600



M.8710

**MINI DRILL STAND**

M.8600	- multi directional tool positioning - ideal when working with flexible shaft art. M.8500 - collar \varnothing 43 mm + reducing collar \varnothing 33 mm	1	091433
M.8710	rotary collar \varnothing 32/48 mm - adjustable angle and height - toothed rack mechanism with return spring and depth stop - height 260 mm - stroke 27 mm - depth 115 mm - working height 100 mm - column \varnothing 16 mm - aluminium base 250 x 180 mm	1	093666

**MINI VICE**

M.8750	- clamp width 45 mm - max opening 50 mm	1	093383
---------------	--	---	--------

**SCREW AND UNSCREW KIT - 45 PCS**

M.8775	1 flexible shaft - 1 precision tweezers 35 assorted bits - 1 screwdriver - 7 socket bits	1	093574
---------------	--	---	--------





PRECISION CUTTERS KIT - 18 PCS

Ideal for working on plastic, ABS panels, wood, plywood, plain paperboard or cardboard

M.8790	<ul style="list-style-type: none"> 1 holder with anti-slip handle for light weight materials, quick attachment of blades 1 holder with anti-slip handle for heavy weight materials, quick attachment of blades 14 assorted precision blades 1 precision screwdriver 1 precision tweezers 	1	093581



Voltage	230 V / 50 Hz
Output	30 Watt
Temperature	450/500 °C
Cable lenght	1,2 m
Weight	94 g

WOODBURNING PEN

To engrave wood, cork, genuine leather, gourds, heavy weight paper, wicker and rattan

M.8800	<ul style="list-style-type: none"> - ABS body - with 2 tips (universal and conical) - with stand 	1	093550

ref.

description

pack
q.tyEAN13
8011017**ACCESSORIES****GLUE GUNS**

Nozzle with heat protection, drip block. Mechanical aid. Shockproof plastic casing. For bonding paper, plastic, wood, ceramic, textiles.



Voltage	230 V / 50 Hz
Output	20 Watt
Cable length	1,8 m
Weight	170 g

**M.8820** glue gun with **2** glue sticks \varnothing **7** mm**1**

093529



Voltage	230 V / 50 Hz
Output	30 Watt
Cable length	1,8 m
Weight	200 g

**M.8815**

- glue gun with **2** glue sticks \varnothing **7** mm
- with ON/OFF button
- self-supporting stand

1

093703



Voltage	230 V / 50 Hz
Output	60 Watt
Cable length	1,8 m
Weight	330 g

**M.8845**

- glue gun with **2** glue sticks \varnothing **11** mm
- with ON/OFF button
- self-supporting stand

1

093710

HOT MELT GLUE STICKS**M.8822** **12** glue sticks \varnothing **7** mm - length **100** mm**10**

600000

M.8857 **12** glue sticks \varnothing **11** mm - length **100** mm**10**

600208



Voltage	230 V / 50 Hz
Secondary Voltage	15 V DC
Outputs	max 12 VA
Speed	single *
Cable length	2 m
Weight	520 g

* Speed depends on tool used

SINGLE SPEED TRANSFORMER

M.9000	- sufficient power for all 6, 25, 30 and 40 Watt tools	1	091440
	- built-in overload cut-off facility for extra safety and extended tool life		



Voltage	0-18 V DC
Output	6 Watt
No load speed	0-17.000 RPM
Shaft holder capacity	ø 2,35 mm
Cable length	1,8 m
Weight	75 g

ENGRAVING PEN

M.9200	- lightweight pen-styled design for comfortable handling	1	091488
	- touch sensitive ON/OFF switch for easy use		
	- simple push in/pull out shaft holder for easy accessory changeover		
	- fast rotary action for effective engraving work		
	- includes 1 diamond engraving bit		
	- available in kit form art. M.9250		

ref.

description

pack
q.tyEAN13
8011017
TOOLS
TRANSFORMERS
KITS

Voltage	230 V / 50 Hz
Output	6 Watt
No load speed	0-17.000 RPM
Shaft holder capacity	ø 2,35 mm
Cable length	1,8 m
Weight	220 g

ENGRAVING PEN WITH TRANSFORMER

M.9220

- lightweight pen-styled design for comfortable handling
- touch sensitive ON/OFF switch for easy use
- simple push in/pull out shaft holder for easy accessory changeover
- fast rotary action for effective engraving work
- includes **1** diamond engraving bit
- available in kit form art. **M.9250**

1

093628



ENGRAVING KIT 6 W

M.9250

- **M.9200** engraving pen
- plug in transformer
- **1** diamond bit
- **3** grinding stones
- **2** stencils
- handy carry and storage case

1

091495



Voltage	0-18 V DC
Output	30 Watt
No load speed	0-30.000 RPM
Chuck type	keyless
Chuck capacity	Ø 0,4-3,2 mm
Cable length	1,8 m
Weight	125 g

HIGH TORQUE ROTARY TOOL

M.9100

- keyless chuck for easy accessory changeover
- high speed for a variety of applications
- pencil grip for an easy use
- includes **3** assorted collets (Ø **2,35 - 3,0 - 3,2 mm**) and **1** nut for extra flexibility
- available in kit form art. **M.9150**

1

091464



MINI ROTARY TOOL KIT 30 W

M.9150

- **M.9100** high torque rotary tool
- **M.9000** single speed transformer
- **29** selected accessories
- handy carry and storage case

1

091471

ref.

description

pack
q.tyEAN13
8011017
**TOOLS
TRANSFORMERS
KITS**

Voltage	230 V / 50 Hz
Output	60 Watt
No load speed	8.000-18.000 RPM
Chuck type	collet
Cable length	1,8 m
Weight	805 g

PRECISION ROTARY TOOL WITH TRANSFORMER

M.9300

- ergonomically designed housing for comfortable gripping
- variable speed for greater accuracy
- shaft locking button
- includes **5** assorted collets (ø 1,0 - 1,5 - 2,35 - 3,0 - 3,2 mm) and 1 nut for extra flexibility
- available in kit form art. **M.9350**

1

093604



PRECISION MINI ROTARY TOOL KIT 60 W

M.9350

- **M.9300** precision rotary tool
- transformer
- **62** selected accessories
- handy carry and storage case

1

093611



Voltage	230 V / 50 Hz
Output	130 Watt
No load speed	8.000-32.000 RPM
Chuck type	keyless
Chuck capacity	ø 0,4-3,2 mm
Cable length	1,9 m
Weight	630 g

HIGH TORQUE ROTARY TOOL

M.9500

- keyless chuck for easy accessory changeover
- ergonomically designed housing for comfortable gripping
- powerful motor and variable speed for increased versatility
- shaft locking button
- includes **3** assorted collets (ø **2,35 - 3,0 - 3,2** mm) and **1** nut for extra flexibility
- **230 V** no need of transformer or adaptors
- available in kit form art. **M.9550**

1

093116



HIGH TORQUE ROTARY TOOL KIT 130 W

M.9550

- **M.9500** variable speed high torque tool
- **60** selected accessories
- handy carry and storage case

1

093123

ref.

description

pack
q.tyEAN13
8011017**TOOLS
TRANSFORMERS
KITS**

Voltage	230 V / 50 Hz
Output	170 Watt
No load speed	8.000-32.000 RPM
Chuck type	keyless
Chuck capacity	ø 0,4-3,2 mm
Cable length	1,9 m
Weight	665 g

**HIGH TORQUE ROTARY TOOL****M.9600**

- keyless chuck for easy accessory changeover
- LCD display/speed control: for more accurate working on different materials
- ergonomically designed housing for comfortable gripping
- powerful motor and variable speed for increased versatility
- shaft locking button
- includes **3** assorted collets (ø **2,35 - 3,0 - 3,2** mm) and **1** nut for extra flexibility
- **230 V** no need of transformer or adaptors
- available in kit form art. **M.9650**

1

093413

**HIGH TORQUE ROTARY TOOL KIT LCD DISPLAY 170 W****M.9650**

- **M.9600** variable speed high torque tool with LCD display
- **60** selected accessories
- handy carry and storage case

1

093420



Total items 36		Total pcs 162	
5x M.1010	5x M.1030	5x M.1080	5x M.1100
5x M.2040	5x M.2070	5x M.2100	5x M.2410
5x M.3630	5x M.4020	5x M.4070	5x M.4680
5x M.5415	5x M.5710	5x M.5715	4x M.8010
4x M.8020	5x M.8100	5x M.8110	4x M.6100
5x M.1240	5x M.1270	5x M.1915	5x M.1970
5x M.3030	5x M.3210	5x M.3610	5x M.3620
5x M.5010	5x M.5030	5x M.5050	5x M.5410
2x M.9150	2x M.9250	1x M.9350	1x M.9550

DISPLAYER*

ESPO.M3A

- height **82** cm
- width **46** cm
- depth **32** cm

1

093727



Total items 32		Total pcs 141	
5x M.1010	5x M.1030	5x M.1080	5x M.1100
5x M.2070	5x M.2100	5x M.2610	5x M.3030
5x M.4020	5x M.4070	5x M.4680	5x M.5030
4x M.8210	4x M.8230	4x M.8250	4x M.8270
5x M.1240	5x M.1270	5x M.1915	5x M.1970
5x M.3640	5x M.3650	5x M.3660	
5x M.5050	5x M.5410	5x M.5710	5x M.8100
1x M.9150	2x M.9250	1x M.9350	1x M.9550

DISPLAYER*

ESPO.M3B

- height **85** cm
- width **46** cm
- depth **32** cm

1

093734

ref.

description

pack
q.ty

EAN13
8011017

DISPLAYERS



Total items
148

Total pcs
709

mini											
4x M. 6100	5x M. 4680	5x M. 4060	5x M. 2910	5x M. 1905	5x M. 1010	5x M. 6005	5x M. 4810	5x M. 4065	5x M. 3020	5x M. 1910	5x M. 1020
5x M. 6006	5x M. 4820	5x M. 4070	5x M. 3030	5x M. 1915	5x M. 1070	5x M. 6008	5x M. 4830	5x M. 4105	5x M. 3210	5x M. 1925	5x M. 1080
5x M. 6010	5x M. 4840	5x M. 4110	5x M. 3220	5x M. 1935	5x M. 1120	5x M. 6012	5x M. 4850	5x M. 4115	5x M. 3230	5x M. 1950	5x M. 1170
5x M. 6020	5x M. 4905	5x M. 4120	5x M. 3610	5x M. 1970	5x M. 1270	5x M. 6206	5x M. 4910	5x M. 4155	5x M. 3620	5x M. 1980	5x M. 1030
5x M. 6208	5x M. 4915	5x M. 4160	5x M. 3630	5x M. 2025	5x M. 1050	5x M. 6210	5x M. 4915	5x M. 4160	5x M. 3640	5x M. 2040	5x M. 1065
5x M. 6212	5x M. 5010	5x M. 4165	5x M. 3650	5x M. 2055	5x M. 1100	5x M. 6215	5x M. 5030	5x M. 4170	5x M. 3660	5x M. 2070	5x M. 1105
4x M. 8010	5x M. 5050	5x M. 4305	5x M. 3670	5x M. 2085	5x M. 1190	4x M. 8020	5x M. 5130	5x M. 4310	5x M. 3680	5x M. 2100	5x M. 1240
4x M. 8100	5x M. 5405	5x M. 4505	5x M. 3690	5x M. 2145	5x M. 1310	5x M. 8110	5x M. 5410	5x M. 4510	5x M. 4005	5x M. 2410	5x M. 1375
5x M. 8110	5x M. 5415	5x M. 4515	5x M. 4005	5x M. 2410	5x M. 1510	5x M. 8120	5x M. 5415	5x M. 4515	5x M. 4010	5x M. 2420	5x M. 1510
4x M. 8550	5x M. 5710	5x M. 4595	5x M. 4010	5x M. 2420	5x M. 1540	4x M. 8550	5x M. 5715	5x M. 4605	5x M. 4015	5x M. 2465	5x M. 1540
4x M. 8560	5x M. 5720	5x M. 4610	5x M. 4020	5x M. 2610	5x M. 1550	4x M. 8560	5x M. 5720	5x M. 4610	5x M. 4020	5x M. 2610	5x M. 1550
4x M. 8580	5x M. 5730	5x M. 4615	5x M. 4055	5x M. 2620	5x M. 1580	3x M. 9300	3x M. 8790	3x M. 8845	20x M. 8857	20x M. 8822	2x M. 9250
3x M. 9500	4x M. 8210	4x M. 8230	4x M. 8250	4x M. 8270	3x M. 9000	3x M. 9600	3x M. 8775	3x M. 8815	3x M. 8845	20x M. 8857	2x M. 9150
3x M. 9600	3x M. 8800	3x M. 8500	3x M. 8750	3x M. 8600	3x M. 9100	3x M. 9200	3x M. 8815	3x M. 8845	20x M. 8857	20x M. 8822	2x M. 9550
3x M. 9000	3x M. 8800	3x M. 8500	3x M. 8750	3x M. 8600	3x M. 9100	3x M. 9200	3x M. 8790	3x M. 8775	3x M. 8815	3x M. 8845	2x M. 9650
3x M. 9100	3x M. 8800	3x M. 8500	3x M. 8750	3x M. 8600	3x M. 9100	3x M. 9200	3x M. 8790	3x M. 8775	3x M. 8815	3x M. 8845	2x M. 9350
3x M. 9200	3x M. 8800	3x M. 8500	3x M. 8750	3x M. 8600	3x M. 9100	3x M. 9200	3x M. 8790	3x M. 8775	3x M. 8815	3x M. 8845	2x M. 9550
3x M. 9220	3x M. 8800	3x M. 8500	3x M. 8750	3x M. 8600	3x M. 9100	3x M. 9200	3x M. 8790	3x M. 8775	3x M. 8815	3x M. 8845	2x M. 9550
2x M. 9250	2x M. 9150	2x M. 9650	2x M. 9350	2x M. 9550	2x M. 9650	2x M. 9350	2x M. 9550	2x M. 9650	2x M. 9350	2x M. 9550	

DISPLAYER*

ESPO.M3C	- height 206 cm - width 100 cm - depth 40 cm	1	093741
-----------------	---	----------	--------

* Standard layout of displayers is flexible and adaptable to any requirement.

INDEX: REFERENCES, QUANTITIES AND BAR CODES

Place number 8011017 before EAN code

ref.	description	ean	page	ref.	description	ean	page
10.010	2 HSS DRILL BITS 1 MM	100104	88	13.740	BIMETAL HOLE SAW 127MM	137407	75
10.015	2 HSS DRILL BITS 1,5 MM	100159	88	13.745	BIMETAL HOLE SAW 140MM	137452	75
10.020	2 HSS DRILL BITS 2 MM	100203	88	13.750	BIMETAL HOLE SAW 152MM	137506	75
10.025	2 HSS DRILL BITS 2,5 MM	100258	88	13.780	BIMETAL ARBOR 14/30MM	137803	74
10.030	2 HSS DRILL BITS 3 MM	100302	88	13.785	BIMETAL ARBOR 32/152MM	137858	74
10.035	2 HSS DRILL BITS 3,5 MM	100357	88	13.790	BIMETAL ARBOR 14/30MM	137902	74
10.040	2 HSS DRILL BITS 4 MM	100401	88	13.795	BIMETAL ARBOR 32/152MM	137957	74
10.045	HSS DRILL BIT 4,5 MM	100456	88	13.800	DRILL FOR BIMETAL ARBOR 115MM	138008	74
10.050	HSS DRILL BIT 5 MM	100500	88	13.805	DRILL FOR BIMETAL ARBOR 70MM	138053	74
10.055	HSS DRILL BIT 5,5 MM	100555	88	14.003	WOOD DRILL BIT 3MM BULK	140032	90
10.060	HSS DRILL BIT 6 MM	100609	88	14.004	WOOD DRILL BIT 4MM BULK	140049	90
10.065	HSS DRILL BIT 6,5 MM	100654	88	14.005	WOOD DRILL BIT 5MM BULK	140056	90
10.070	HSS DRILL BIT 7 MM	100708	88	14.006	WOOD DRILL BIT 6MM BULK	140063	90
10.075	HSS DRILL BIT 7,5 MM	100753	88	14.007	WOOD DRILL BIT 7MM BULK	140070	90
10.080	HSS DRILL BIT 8 MM	100807	88	14.008	WOOD DRILL BIT 8MM BULK	140087	90
10.085	HSS DRILL BIT 8,5 MM	100852	88	14.009	WOOD DRILL BIT 9MM BULK	140094	90
10.090	HSS DRILL BIT 9 MM	100906	88	14.010	WOOD DRILL BIT 10MM BULK	140100	90
10.095	HSS DRILL BIT 9,5 MM	100951	88	14.011	WOOD DRILL BIT 11MM BULK	140117	90
10.100	HSS DRILL BIT 10 MM	101002	88	14.012	WOOD DRILL BIT 12MM BULK	140124	90
10.105	HSS DRILL BIT 10,5MM	101057	88	14.013	WOOD DRILL BIT 13MM BULK	140131	90
10.110	HSS DRILL BIT 11 MM	101101	88	14.014	WOOD DRILL BIT 14MM BULK	140148	90
10.115	HSS DRILL BIT 11,5MM	101156	88	14.015	WOOD DRILL BIT 15MM BULK	140155	90
10.120	HSS DRILL BIT 12 MM	101200	88	14.016	WOOD DRILL BIT 16MM BULK	140162	90
10.125	HSS DRILL BIT 12,5MM	101255	88	14.018	WOOD DRILL BIT 18MM BULK	140186	90
10.130	HSS DRILL BIT 13 MM	101309	88	14.020	WOOD DRILL BIT 20MM BULK	140209	90
103.1/4	TAP RE-SEATING TOOL 1/2	103143	8	14.022	WOOD DRILL BIT 22MM BULK	140223	90
103.6MA	TAP RE-SEATING TOOL 1/2	103006	8	14.024	WOOD DRILL BIT 24MM BULK	140247	90
11.010	CUTTER 10MM GMA	110103	9	14.026	WOOD DRILL BIT 26MM BULK	140261	90
11.012	CUTTER 12MM GMA	110127	9	14.028	WOOD DRILL BIT 28MM BULK	140285	90
11.014	CUTTER 14MM GMA 3/8	110141	9	14.030	WOOD DRILL BIT 30MM BULK	140308	90
11.017	CUTTER 17MM GMA 1/2	110172	9	14.206	WOOD DRILL BIT 6X250MM	142067	90
11.024	CUTTER 24MM GMA 3/4	110240	9	14.207	WOOD DRILL BIT 7X250MM	142074	90
11.028	CUTTER 28MM GMA 1"	110288	9	14.208	WOOD DRILL BIT 8X250MM	142081	90
11.034	CUTTER 34MM 1/4 1"1/8"	110349	9	14.209	WOOD DRILL BIT 9X250MM	142098	90
11.038	CUTTER 38MM 1/4 1"1/4	110387	9	14.210	WOOD DRILL BIT 10X250MM	142104	90
11.043	CUTTER 43MM 1/4 1"1/2	110431	9	14.211	WOOD DRILL BIT 11X250MM	142111	90
11.055	CUTTER 55MM 1/4 2"	110554	9	14.212	WOOD DRILL BIT 12X250MM	142128	90
12.010	FORSTNER BIT 10MM	120102	42	14.213	WOOD DRILL BIT 13X250MM	142135	90
12.012	FORSTNER BIT 12MM	120126	42	14.214	WOOD DRILL BIT 14X250MM	142142	90
12.014	FORSTNER BIT 14MM	120140	42	14.215	WOOD DRILL BIT 15X250MM	142159	90
12.015	FORSTNER BIT 15MM	120157	42	14.216	WOOD DRILL BIT 16X250MM	142166	90
12.016	FORSTNER BIT 16MM	120164	42	14.218	WOOD DRILL BIT 18X250MM	142180	90
12.018	FORSTNER BIT 18MM	120188	42	14.220	WOOD DRILL BIT 20X250MM	142203	90
12.020	FORSTNER BIT 20MM	120201	42	14.222	WOOD DRILL BIT 22X250MM	142227	90
12.022	FORSTNER BIT 22MM	120225	42	14.224	WOOD DRILL BIT 24X250MM	142241	90
12.024	FORSTNER BIT 24MM	120249	42	15.030	MASONRY DRILL BIT 3MM	150307	89
12.025	FORSTNER BIT 25MM	120256	42	15.040	MASONRY DRILL BIT 4MM	150406	89
12.026	FORSTNER BIT 26MM	120263	42	15.050	MASONRY DRILL BIT 5MM	150505	89
12.028	FORSTNER BIT 28MM	120287	42	15.060	MASONRY DRILL BIT 6MM	150604	89
12.030	FORSTNER BIT 30MM	120300	42	15.070	MASONRY DRILL BIT 7MM	150703	89
12.032	FORSTNER BIT 32MM	120324	42	15.080	MASONRY DRILL BIT 8MM	150802	89
12.034	FORSTNER BIT 34MM	120348	42	15.090	MASONRY DRILL BIT 9MM	150901	89
12.035	FORSTNER BIT 35MM	120355	42	15.100	MASONRY DRILL BIT 10MM	151007	89
12.036	FORSTNER BIT 36MM	120362	42	15.120	MASONRY DRILL BIT 12MM	151205	89
12.040	FORSTNER BIT 40MM	120409	42	15.140	MASONRY DRILL BIT 14MM	151403	89
12.045	FORSTNER BIT 45MM	120454	42	15.606	SET 5 WOOD DRILLS 4/10MM	156064	91
12.050	FORSTNER BIT 50MM	120508	42	15.607	SET 8 WOOD DRILLS 3/10MM	156071	91
13.500	BIMETAL HOLE SAW 14MM	135007	75	15.608	SET 5 MASONRY DRILLS 4/10MM	156088	91
13.505	BIMETAL HOLE SAW 16MM	135052	75	15.610	SET 8 MASONRY DRILLS 3/10MM	156101	91
13.510	BIMETAL HOLE SAW 17MM	135106	75	15.615	SET 13 HSS TW.DRILLS 1,5/6,5MM	156156	91
13.515	BIMETAL HOLE SAW 19MM	135151	75	15.620	SET 13 HSS TWIST DRILLS 2/8MM	156200	91
13.520	BIMETAL HOLE SAW 20MM	135205	75	15.630	SET 9 MASONRY-HSS DRILLS	156309	91
13.525	BIMETAL HOLE SAW 21MM	135250	75	15.640	SET 9 HSS-WOOD-MASONRY DRILLS	156408	91
13.530	BIMETAL HOLE SAW 22MM	135304	75	16.030	MASONRY DRILL BIT 3MM BULK	160306	89
13.535	BIMETAL HOLE SAW 24MM	135359	75	16.040	MASONRY DRILL BIT 4MM BULK	160405	89
13.540	BIMETAL HOLE SAW 25MM	135403	75	16.050	MASONRY DRILL BIT 5MM BULK	160504	89
13.545	BIMETAL HOLE SAW 27MM	135458	75	16.055	MASONRY DRILL BIT 5,5MM BULK	160559	89
13.550	BIMETAL HOLE SAW 29MM	135502	75	16.060	MASONRY DRILL BIT 6MM BULK	160603	89
13.555	BIMETAL HOLE SAW 30MM	135557	75	16.065	MASONRY DRILL BIT 6,5MM BULK	160658	89
13.560	BIMETAL HOLE SAW 32MM	135601	75	16.070	MASONRY DRILL BIT 7MM BULK	160702	89
13.565	BIMETAL HOLE SAW 33MM	135656	75	16.080	MASONRY DRILL BIT 8MM BULK	160801	89
13.570	BIMETAL HOLE SAW 35MM	135700	75	16.090	MASONRY DRILL BIT 9MM BULK	160900	89
13.575	BIMETAL HOLE SAW 37MM	135755	75	16.100	MASONRY DRILL BIT 10MM BULK	161006	89
13.580	BIMETAL HOLE SAW 38MM	135809	75	16.110	MASONRY DRILL BIT 11MM BULK	161105	89
13.585	BIMETAL HOLE SAW 40MM	135854	75	16.120	MASONRY DRILL BIT 12MM BULK	161204	89
13.590	BIMETAL HOLE SAW 41MM	135908	75	16.130	MASONRY DRILL BIT 13MM BULK	161303	89
13.595	BIMETAL HOLE SAW 43MM	135953	75	16.140	MASONRY DRILL BIT 14MM BULK	161402	89
13.600	BIMETAL HOLE SAW 44MM	136004	75	16.150	MASONRY DRILL BIT 15MM BULK	161501	89
13.605	BIMETAL HOLE SAW 46MM	136059	75	16.160	MASONRY DRILL BIT 16MM BULK	161600	89
13.610	BIMETAL HOLE SAW 48MM	136103	75	16.180	MASONRY DRILL BIT 18MM BULK	161808	89
13.615	BIMETAL HOLE SAW 51MM	136158	75	16.200	MASONRY DRILL BIT 20MM BULK	162003	89
13.620	BIMETAL HOLE SAW 52MM	136202	75	16.408	MASONRY DRILL BIT 8X400MM	164083	89
13.625	BIMETAL HOLE SAW 54MM	136257	75	16.410	MASONRY DRILL BIT 10X400MM	164106	89
13.630	BIMETAL HOLE SAW 57MM	136301	75	16.412	MASONRY DRILL BIT 12X400MM	164120	89
13.635	BIMETAL HOLE SAW 59MM	136356	75	16.414	MASONRY DRILL BIT 14X400MM	164144	89
13.640	BIMETAL HOLE SAW 60MM	136400	75	16.416	MASONRY DRILL BIT 16X400MM	164168	89
13.645	BIMETAL HOLE SAW 64MM	136455	75	16.418	MASONRY DRILL BIT 18X400MM	164182	89
13.650	BIMETAL HOLE SAW 65MM	136509	75	16.420	MASONRY DRILL BIT 20X400MM	164205	89
13.655	BIMETAL HOLE SAW 67MM	136554	75	16.422	MASONRY DRILL BIT 22X400MM	164229	89
13.660	BIMETAL HOLE SAW 70MM	136608	75	16.425	MASONRY DRILL BIT 25X400MM	164250	89
13.665	BIMETAL HOLE SAW 73MM	136653	75	16.610	MASONRY DRILL BIT 10X600MM	166100	89
13.670	BIMETAL HOLE SAW 76MM	136707	75	16.612	MASONRY DRILL BIT 12X600MM	166124	89
13.675	BIMETAL HOLE SAW 79MM	136752	75	16.614	MASONRY DRILL BIT 14X600MM	166148	89
13.680	BIMETAL HOLE SAW 83MM	136806	75	16.616	MASONRY DRILL BIT 16X600MM	166162	89
13.685	BIMETAL HOLE SAW 86MM	136851	75	16.618	MASONRY DRILL BIT 18X600MM	166186	89
13.690	BIMETAL HOLE SAW 89MM	136905	75	16.620	MASONRY DRILL BIT 20X600MM	166209	89
13.695	BIMETAL HOLE SAW 92MM	136950	75	17.010	HSS DRILL BIT 1 MM BULK	170107	88
13.700	BIMETAL HOLE SAW 95MM	137001	75	17.015	HSS DRILL BIT 1,5 MM BULK	170152	88
13.705	BIMETAL HOLE SAW 98MM	137056	75	17.020	HSS DRILL BIT 2 MM BULK	170206	88
13.710	BIMETAL HOLE SAW 102MM	137100	75	17.025	HSS DRILL BIT 2,5 MM BULK	170251	88
13.715	BIMETAL HOLE SAW 105MM	137155	75	17.030	HSS DRILL BIT 3 MM BULK	170305	88
13.720	BIMETAL HOLE SAW 108MM	137209	75	17.035	HSS DRILL BIT 3,5 MM BULK	170350	88
13.725	BIMETAL HOLE SAW 111MM	137254	75	17.040	HSS DRILL BIT 4 MM BULK	170404	88
13.730	BIMETAL HOLE SAW 114MM	137308	75	17.045	HSS DRILL BIT 4,5 MM BULK	170459	88
13.735	BIMETAL HOLE SAW 121MM	137353	75	17.050	HSS DRILL BIT 5 MM BULK	170503	88

INDEX: REFERENCES, QUANTITIES AND BAR CODES

Place number 8011017 before EAN code

ref.	description	ean	page	ref.	description	ean	page
17.055	HSS DRILL BIT 5,5 MM BULK	10 170558	88	339.35	COTTON BUFFING WHEEL 100MM	10 339351	15
17.060	HSS DRILL BIT 6 MM BULK	10 170602	88	339.40	COTTON BUFFING WHEEL 120MM	10 339405	15
17.065	HSS DRILL BIT 6,5 MM BULK	10 170657	88	339.45	COTTON BUFFING WHEEL 150MM	10 339450	15
17.070	HSS DRILL BIT 7 MM BULK	10 170701	88	339.46	COTTON AND SISAL WHEEL 80MM	10 339467	16
17.075	HSS DRILL BIT 7,5 MM BULK	10 170756	88	339.49	COTTON AND SISAL WHEEL 150MM	10 339498	16
17.080	HSS DRILL BIT 8 MM BULK	10 170800	88	339.50	POLISHING CUSHION PAD 125MM	1 339504	16
17.085	HSS DRILL BIT 8,5 MM BULK	10 170855	88	339.60	POLISHING CUSHION PAD 175MM 14	1 339603	16
17.090	HSS DRILL BIT 9 MM BULK	10 170909	88	339.62	POLISHING CUSHION PAD 125MM	1 339627	16
17.095	HSS DRILL BIT 9,5 MM BULK	10 170954	88	339.64	POLISHING CUSHION PAD 175MM	1 339641	16
17.100	HSS DRILL BIT 10 MM BULK	10 171005	88	339.66	VELCRO POLISH.CUSHION PAD 115MM	1 339665	16
17.105	HSS DRILL BIT 10,5MM BULK	10 171050	88	339.67	VELCRO POLISH.CUSHION PAD 125M	1 339672	16
17.110	HSS DRILL BIT 11 MM BULK	10 171104	88	339.68	VELCRO POLISH.CUSHION PAD 160M	1 339689	16
17.115	HSS DRILL BIT 11,5MM BULK	10 171159	88	339.70	SMOOTHING BLOCK 125X70MM	10 339702	18
17.120	HSS DRILL BIT 12 MM BULK	10 171203	88	339.72	SMOOTHING BLOCK 125X70 VELCRO	5 339726	18
17.125	HSS DRILL BIT 12,5MM BULK	10 171258	88	339.73	SMOOTHING BLOCK 125MM VELCRO	5 339733	18
17.130	HSS DRILL BIT 13 MM BULK	10 171302	88	339.74	SMOOTHING BLOCK 125MM VELCRO	5 339740	18
17.135	HSS DRILL BIT 13,5MM BULK	5 171357	88	339.75	SMOOTHING BLOCK 125MM VELCRO	5 339757	18
17.140	HSS DRILL BIT 14 MM BULK	5 171401	88	339.76	SMOOTHING BLOCK 150MM VELCRO	5 339764	18
17.145	HSS DRILL BIT 14,5MM BULK	5 171456	88	339.79	MINI-SMOOTHING BLOCK VELCRO	5 339795	18
17.150	HSS DRILL BIT 15 MM BULK	5 171500	88	339.80	SANDING SPONGE GR.60/100	10 339801	18
17.155	HSS DRILL BIT 15,5MM BULK	5 171555	88	339.81	250 ABRASIVE SPONGES GR.60/100	1 339818	18
17.160	HSS DRILL BIT 16 MM BULK	5 171609	88	339.85	24 ABRASIVE SPONGES GR.60/100	1 339856	18
201.1/4	TAP RE-SEATING TOOL 3/8-1"	1 201146	8	339.90	2 AUTO SPONGES GR.100	10 339900	18
201.6MA	TAP RE-SEATING TOOL 3/8-1"	1 201009	8	339.91	250 ABRASIVE SPONGES GR.100	1 339917	18
202.1/4	TAP RE-SEATING TOOL 3/8-1"	1 202143	8	340.00	15 PAPER SAND. DISCS 125 G. 50	10 340005	19
202.6MA	TAP RE-SEATING TOOL 3/8-1"	1 202006	8	341.00	15 PAPER SAND. DISCS 125 G. 80	10 341002	19
203.6MA	TAP RE-SEATING TOOL 1/2-3/4	1 203003	8	342.00	15 PAPER SAND. DISCS 125 G.120	10 342009	19
204.1/4	TAP RE-SEATING TOOL 1"1/8-2"	1 204147	8	343.00	15 PAPER SANDING DISCS 125 ASS	10 343006	19
205.6MA	TAP RE-SEATING TOOL 3/8-1"	1 205007	8	344.00	5 PAPER SAND. DISCS 125 GR. 50	10 344003	19
207.6MA	TAP RE-SEATING TOOL 3/8-1"	1 207001	8	344.10	5 PAPER SAND. DISCS 125 GR. 80	10 344102	19
208.6MA	TAP RE-SEATING TOOL 10-16MM	1 208008	8	344.20	5 PAPER SAND. DISCS 125 GR.120	10 344201	19
209.6MA	TAP RE-SEATING TOOL 13-16MM	1 209005	8	344.30	5 PAPER SANDING DISCS 125 ASS.	10 344300	19
210.6MA	TAP RE-SEATING TOOL 3/8-1"	1 210001	9	345.10	TUNGSTEN CARBIDE DISC MEDIUM	10 345109	30
212.1/4	TAP RE-SEATING TOOL 3/8-1/2	10 212142	8	345.20	TUNGSTEN CARBIDE DISC FINE	10 345208	30
212.6MA	TAP RE-SEATING TOOL 3/8-1/2	10 212005	8	347.00	6 FIBRE BACKED DISCS 115 G. 36	10 347004	19
213.6MA	TAP RE-SEATING TOOL 3/8-1/2	10 213002	9	347.10	6 FIBRE BACKED DISCS 115 G. 60	10 347103	19
214.00	HOLE CUTTER 20/123MM	5 214009	12	347.20	6 FIBRE BACKED DISCS 115 G.100	10 347202	19
214.10	HSS CUTTING TOOL 5MM	5 214108	12	348.00	6 FIBRE BACKED DISCS 180 G. 36	10 348001	19
215.00	HOLE CUTTER 25/217MM	5 215006	12	348.10	6 FIBRE BACKED DISCS 180 G. 60	10 348100	19
215.10	HSS CUTTING TOOL 6MM	5 215105	12	348.20	6 FIBRE BACKED DISCS 180 G.100	10 348209	19
216.00	HOLE CUTTER 27/104MM	5 216003	12	348.25	10 VELCRO ABR. SHEETS 339.79	5 348254	18
216.10	HSS CUTTING TOOL 5MM	5 216102	12	348.26	10 VELCRO ABR. SHEETS 339.79	5 348261	18
217.00	TILE CUTTER 30/100MM	1 217000	74	348.27	10 VELCRO ABR. SHEETS 339.79	5 348278	18
217.10	CUTTING TOOL FOR ART.	1 217109	74	348.30	5 VELCRO ABRASIVE SHEETS 40	10 348308	20
218.00	CONE-SHAPED NUT 14MA	10 218007	13	348.31	25 VELCRO ABRASIVE SHEETS 40	1 348315	20
219.00	FLAT NUT 14MA	10 219004	13	348.35	5 VELCRO ABRASIVE SHEETS 60	10 348353	20
220.00	CONE-SHAPED NUT 8MA BULK	10 220000	13	348.36	25 VELCRO ABRASIVE SHEETS 60	1 348360	20
220.50	CONE-SHAPED NUT 10MA COL.16 B	10 220505	13	348.40	5 VELCRO ABRASIVE SHEETS 80	10 348407	20
221.00	CONE-SHAPED NUT 10MA BULK	10 221007	13	348.41	25 VELCRO ABRASIVE SHEETS 80	1 348414	20
222.00	CONE-SHAPED NUT 14MA BULK	10 222004	13	348.45	5 VELCRO ABRASIVE SHEETS 120	10 348452	20
223.00	CONE-SHAPED NUT 5/8 BULK	10 223001	13	348.46	25 VELCRO ABRASIVE SHEETS 120	1 348469	20
224.00	FLAT NUT 8MA BULK	10 224008	13	348.50	5 VELCRO ABRASIVE SHEETS 240	10 348506	20
225.00	FLAT NUT 10MA BULK	10 225005	13	348.51	25 VELCRO ABRASIVE SHEETS 240	1 348513	20
226.00	FLAT NUT 14MA BULK	10 226002	13	348.56	25 VELCRO ABRASIVE SHEETS ASS.	1 348568	20
227.00	FLAT NUT 5/8 BULK	10 227009	13	349.00	10 VELCRO ABR. DISCS 115 G. 40	10 349008	20
228.00	STEEL UNIVERSAL WRENCH 35MM	10 228006	13	349.01	25 VELCRO ABR. DISCS 115 G. 40	1 349015	20
229.00	STEEL UNIVERSAL WRENCH 35 BULK	10 229003	13	349.10	10 VELCRO ABR. DISCS 115 G.120	10 349107	20
230.00	ADJU. STEEL UNIV. WRENCH 20/35	10 230009	13	349.11	25 VELCRO ABR. DISCS 115 G.120	1 349114	20
231.00	ADJU. STEEL UNIV. WRENCH 20/35	10 231006	13	349.20	10 VELCRO ABR. DISCS 115 G.240	10 349206	20
250.00	BACK NUT FOR DISC 115MM	1 250007	13	349.21	25 VELCRO ABR. DISCS 115 G.240	1 349213	20
253.00	BACK NUT FOR DISC 230MM	1 253008	13	349.30	10 VELCRO ABR. DISCS 115 G.ASS	10 349305	20
300.00	PIPE FLARING KIT 10/16MM	1 300009	9	349.31	25 VELCRO ABR. DISCS 115 G.ASS	1 349312	20
304.00	PIPE FLARING KIT 10/22MM	1 304007	9	349.33	10 VELCRO ABR. DISCS 115 G. 40	10 349336	21
305.00	LAVABO WRENCH	5 305004	10	349.34	25 VELCRO ABR. DISCS 115 G. 40	1 349343	21
316.00	16MM PIPE CUTTER	5 316000	10	349.35	10 VELCRO ABR. DISCS 115 G. 80	10 349350	21
328.00	28MM PIPE CUTTER	5 328003	10	349.36	25 VELCRO ABR. DISCS 115 G. 80	1 349367	21
332.00	32MM PIPE CUTTER	5 332000	10	349.40	10 VELCRO ABR. DISCS 115 G.120	10 349404	21
332.35	35MM TELESCOPIC PIPE CUTTER	5 332352	10	349.41	25 VELCRO ABR. DISCS 115 G.120	1 349411	21
333.00	UNIVERSAL CUTTING WHEEL	10 333007	10	349.45	10 VELCRO ABR. DISCS 115 G.240	10 349459	21
334.00	42MM TELESCOPIC PIPE CUTTER	1 334004	10	349.46	25 VELCRO ABR. DISCS 115 G.240	1 349466	21
334.20	CUTTING WHEEL FOR 334.00	10 334202	10	349.50	10 VELCRO ABR. DISCS 115 G.ASS	10 349503	21
335.00	ARBOR 10X6MM	10 335001	13	349.51	25 VELCRO ABR. DISCS 115 G.ASS	1 349510	21
336.00	ARBOR 12,8X8MM	10 336008	13	349.55	10 VELCRO ABR. DISCS 125 G. 40	10 349558	20
337.00	ARBOR 22,2X8MM	10 337005	13	349.56	25 VELCRO ABR. DISCS 125 G. 40	1 349565	20
338.00	RUBBER BACKING PAD 125MM	10 338002	14	349.60	10 VELCRO ABR. DISCS 125 G.120	10 349602	20
338.05	RUBBER BACKING PAD 180MM	10 338057	14	349.61	25 VELCRO ABR. DISCS 125 G.120	1 349619	20
338.08	RUBBER BACKING PAD 180MM BULK	10 338088	14	349.65	10 VELCRO ABR. DISCS 125 G.240	10 349657	20
338.10	NYLON BACKING PAD 100X10MM	10 338101	14	349.66	25 VELCRO ABR. DISCS 125 G.240	1 349664	20
338.20	NYLON BACKING PAD 115X14MM	10 338200	14	349.70	10 VELCRO ABR. DISCS 125 G.ASS	10 349701	20
338.22	NYLON BACKING PAD 178X14MM	10 338224	14	349.71	25 VELCRO ABR. DISCS 125 G.ASS	1 349718	20
338.25	NYLON BACKING PAD 100X10 BULK	10 338255	14	349.73	10 VELCRO ABR. DISCS 125 G. 40	10 349732	21
338.30	NYLON BACKING PAD 115X10 BULK	10 338309	14	349.74	25 VELCRO ABR. DISCS 125 G. 40	1 349749	21
338.35	NYLON BACKING PAD 115X14 BULK	10 338354	14	349.75	10 VELCRO ABR. DISCS 125 G. 80	10 349756	21
338.40	NYLON BACKING PAD 115X16 BULK	10 338408	14	349.76	25 VELCRO ABR. DISCS 125 G. 80	1 349763	21
338.45	NYLON BACKING PAD 125X14 BULK	10 338453	14	349.80	10 VELCRO ABR. DISCS 125 G.120	10 349800	21
338.50	NYLON BACKING PAD 125X16 BULK	10 338507	14	349.81	25 VELCRO ABR. DISCS 125 G.120	1 349817	21
338.55	NYLON BACKING PAD 150X14 BULK	10 338552	14	349.85	10 VELCRO ABR. DISCS 125 G.240	10 349855	21
338.60	NYLON BACKING PAD 150X16 BULK	10 338606	14	349.86	25 VELCRO ABR. DISCS 125 G.240	1 349862	21
338.65	NYLON BACKING PAD 178X14 BULK	10 338651	14	349.90	10 VELCRO ABR. DISCS 125 G.ASS	10 349909	21
338.70	NYLON BACKING PAD 178X16 BULK	10 338705	14	349.91	25 VELCRO ABR. DISCS 125 G.ASS	1 349916	21
338.75	NYLON BACKING PAD 178X14 WHITE	10 338750	14	349.95	10 VELCRO ABR. DISCS 150 G. 40	10 349954	21
338.80	VELCRO BACKING PAD 115MM M14	5 338804	14	349.96	10 VELCRO ABR. DISCS 150 G. 80	10 349961	21
338.82	VELCRO BACKING PAD 125MM M14	5 338828	14	349.97	10 VELCRO ABR. DISCS 150 G.120	10 349978	21
338.85	VELCRO BACKING PAD 150MM M14	5 338859	14	349.98	10 VELCRO ABR. DISCS 150 G.240	10 349985	21
339.00	LAMBSWOOL BONNET 140MM	10 339009	15	349.99	10 VELCRO ABR. DISCS 150 G.ASS	10 349992	21
339.20	LAMBSWOOL BONNET 190MM	10 339207	15	350.00	6 EMERY CLOTH DISCS 125 GR. 40	10 350004	19
339.22	VELCRO LAMBSWOOL BONNET 115MM	10 339221	15	351.00	6 EMERY CLOTH DISCS 125 GR. 80	10 351001	19
339.23	VELCRO LAMBSWOOL BONNET 125MM	10 339238	15	352.00	6 EMERY CLOTH DISCS 125 GR.120	10 352008	19
339.24	VELCRO LAMBSWOOL BONNET 160MM	10 339245	15	353.00	6 EMERY CLOTH DISCS 125 ASS.	10 353005	19
339.25	FELT BUFFING DISC 80X10MM	10 339252	15	354.00	10 VEL.ABR. SHEETS 93X185 40	5 354002	25
339.26	VELCRO FELT BUFFING DISC 125MM	10 339269	15	354.03	10 VEL.ABR. SHEETS 93X185 80	5 354033	25
339.27	FELT BUFFING DISC 125X15MM	10 339276	15	354.06	10 VEL.ABR. SHEETS 93X185 120	5 354064	25
339.28	FELT BUFFING DISC 150X20MM	10 339283	15	354.09	10 VEL.ABR. SHEETS 93X185 180	5 354095	25
339.29	VELCRO FELT POLISHING PAD 93MM	10 339290	15	354.12	10 VEL.ABR. SHEETS 93X185 ASS	5 354125	25
339.30	COTTON BUFFING WHEEL 80MM	10 339306	15	354.15	10 VEL.ABR. SHEETS 93X185 40	5 354156	25

INDEX: REFERENCES, QUANTITIES AND BAR CODES

Place number 8011017 before EAN code

ref.	description	☐	ean	page	ref.	description	☐	ean	page
354.18	10 VEL.ABR. SHEETS 93X185 80	5	354187	25	358.20	FLAP SANDING DISC 115 NYLON120	10	358208	30
354.21	10 VEL.ABR. SHEETS 93X185 120	5	354217	25	358.25	FLAP SANDING DISC 180 NYLON 40	10	358253	30
354.24	10 VEL.ABR. SHEETS 93X185 180	5	354248	25	358.30	FLAP SANDING DISC 180 NYLON 80	10	358307	30
354.27	10 VEL.ABR. SHEETS 93X185 ASS	5	354279	25	358.35	FLAP SANDING DISC 180 NYLON120	10	358352	30
354.30	10 ABRASIVE SHEETS 93X230 40	5	354309	25	358.40	FLAP SANDING WHEEL 40X20MM 80	10	358406	29
354.33	10 ABRASIVE SHEETS 93X230 80	5	354330	25	358.50	FLAP SANDING WHEEL 50X20MM 80	10	358505	29
354.36	10 ABRASIVE SHEETS 93X230 120	5	354361	25	358.60	FLAP SANDING WHEEL 60X40MM 80	10	358604	29
354.39	10 ABRASIVE SHEETS 93X230 180	5	354392	25	358.80	FLAP SANDING WHEEL 80X30MM 80	10	358802	29
354.42	10 ABRASIVE SHEETS 93X230 ASS	5	354422	25	358.90	40 ASSORTED ROTARY FLAP SANDER	1	358901	29
354.45	10 ABRASIVE SHEETS 93X230 40	5	354453	26	359.00	FLAP SANDING DISC 115 FIBRE 80	10	359007	30
354.48	10 ABRASIVE SHEETS 93X230 80	5	354484	26	359.05	FLAP SANDING DISC 180 FIBRE 80	10	359052	30
354.51	10 ABRASIVE SHEETS 93X230 120	5	354514	26	359.10	FLAP SANDING DISC 115 FIBRE 40	10	359106	30
354.54	10 ABRASIVE SHEETS 93X230 180	5	354545	26	359.15	FLAP SANDING DISC 115 FIBRE 80	10	359151	30
354.57	10 ABRASIVE SHEETS 93X230 ASS	5	354576	26	359.20	FLAP SANDING DISC 115 FIBRE120	10	359205	30
354.60	10 VEL.ABR. SHEETS 115X230 40	5	354606	26	359.25	FLAP SANDING DISC 180 FIBRE 40	10	359250	30
354.63	10 VEL.ABR. SHEETS 115X230 80	5	354637	26	359.30	FLAP SANDING DISC 180 FIBRE 80	10	359304	30
354.66	10 VEL.ABR. SHEETS 115X230 120	5	354668	26	359.35	FLAP SANDING DISC 180 FIBRE120	10	359359	30
354.69	10 VEL.ABR. SHEETS 115X230 180	5	354699	26	359.36	2 PRE-POLISHING PASTES	10	359366	16
354.72	10 VEL.ABR. SHEETS 115X230 ASS	5	354729	26	359.37	2 FINAL POLISHING PASTES	10	359373	16
354.75	10 ABRASIVE SHEETS 115X280 40	5	354750	26	359.38	2 ASSORTED POLISHING PASTES	10	359380	16
354.78	10 ABRASIVE SHEETS 115X280 80	5	354781	26	359.40	FLAP WHEEL ABR.CLOTH 50X25	5	359403	17
354.81	10 ABRASIVE SHEETS 115X280 120	5	354811	26	359.42	FLAP WHEEL ABR.CLOTH 75X45	5	359427	17
354.84	10 ABRASIVE SHEETS 115X280 180	5	354842	26	359.44	FLAP WHEEL ABR.CLOTH 100X50	5	359441	17
354.87	10 ABRASIVE SHEETS 115X280 ASS	5	354873	26	359.46	FLAP WHEEL ABR./EME.CLOTH 50X25	5	359465	17
355.00	SAND.PAPER + EMERY CLOTH DISCS	10	355009	19	359.48	FLAP WHEEL ABR./EME.CLOTH 75X45	5	359489	17
355.10	3 SANDING BELTS 400X60 GR. 40	3	355108	27	359.50	FLAP WHEEL ABR./EME.CLOTH100X50	5	359502	17
355.11	3 SANDING BELTS 400X60 GR. 60	3	355115	27	359.70	FLAP WHEEL ABR.CLOTH 150X25	5	359700	17
355.12	3 SANDING BELTS 400X60 GR. 80	3	355122	27	359.72	FLAP WHEEL ABR./EME.CLOTH150X25	5	359724	17
355.13	3 SANDING BELTS 400X60 GR.100	3	355139	27	359.82	FIBRE NYLON DISC 100X13MM	5	359823	17
355.14	3 SANDING BELTS 400X60 GR.150	3	355146	27	359.86	FIBRE NYLON DISC 115X22MM	5	359861	17
355.15	3 SANDING BELTS 560X100 GR. 40	2	355153	27	360.00	HOLLOW BEADING CUTTER 35MM	5	360003	39
355.16	3 SANDING BELTS 560X100 GR. 60	2	355160	27	361.00	CONVEX CUTTER 35MM	5	361000	39
355.17	3 SANDING BELTS 560X100 GR. 80	2	355177	27	362.00	COVING CUTTER 35MM	5	362007	39
355.18	3 SANDING BELTS 560X100 GR.100	2	355184	27	363.00	ROUNDING OFF CUTTER 35MM	5	363004	39
355.19	3 SANDING BELTS 560X100 GR.150	2	355191	27	364.00	TRIMMING CUTTER 25MM	5	364001	39
355.20	3 SANDING BELTS 610X100 GR. 40	2	355207	27	364.50	ROUNDING OFF CUTTER 25MM	5	364506	39
355.21	3 SANDING BELTS 610X100 GR. 60	2	355214	27	365.00	CHAMFERING CUTTER 35MM	5	365008	39
355.22	3 SANDING BELTS 610X100 GR. 80	2	355221	27	366.00	STRAIGHT FACE CUTTER 35MM	5	366005	39
355.23	3 SANDING BELTS 610X100 GR.100	2	355238	27	367.00	TONGUE CUTTER 30MM	5	367002	39
355.24	3 SANDING BELTS 610X100 GR.150	2	355245	27	368.00	SLOTING CUTTER 30X1,5MM	5	368009	39
355.25	3 SANDING BELTS 620X100 GR. 40	2	355252	27	369.00	SLOTING CUTTER 30X2,5MM	5	369006	39
355.26	3 SANDING BELTS 620X100 GR. 60	2	355269	27	370.00	SLOTING SAW 45MM	5	370002	39
355.27	3 SANDING BELTS 620X100 GR. 80	2	355276	27	372.00	STRAIGHT CUTTER 2 FLUTES 6MM	5	372006	39
355.28	3 SANDING BELTS 620X100 GR.100	2	355283	27	373.00	ADJUSTABLE HAND SHAPER	1	373003	39
355.29	3 SANDING BELTS 620X100 GR.150	2	355290	27	374.03	ADJUSTABLE COUNTERSINK 3MM	10	374031	39
355.60	6 FINISHING PAPER SHEETS GR 60	10	355603	22	374.04	ADJUSTABLE COUNTERSINK 4MM	10	374048	39
355.62	6 FINISHING PAPER SHEETS GR100	10	355627	22	374.05	ADJUSTABLE COUNTERSINK 5MM	10	374055	39
355.64	6 FINISHING PAPER SHEETS GR150	10	355641	22	374.06	ADJUSTABLE COUNTERSINK 6MM	10	374062	39
355.66	6 FINISHING PAPER SHEETS ASS.	10	355665	22	375.00	COUNTERSINK 6MM	10	375007	40
355.70	6 WET+DRY PAPER SHEETS GR 180	10	355702	22	376.00	COUNTERSINK 12MM	10	376004	40
355.72	6 WET+DRY PAPER SHEETS GR 320	10	355726	22	377.00	COUNTERSINK 16MM	10	377001	40
355.74	6 WET+DRY PAPER SHEETS GR 600	10	355740	22	378.00	COUNTERSINK 19MM	10	378008	40
355.76	6 WET+DRY PAPER SHEETS ASS.	10	355764	22	379.00	COUNTERSINK 13MM	10	379005	40
355.80	6 EMERY CLOTH SHEETS GR 60	10	355801	23	379.50	HINGE BORING BIT 20MM	10	379500	40
355.82	6 EMERY CLOTH SHEETS GR 120	10	355825	23	380.00	HINGE BORING BIT 26MM	10	380001	40
355.84	6 EMERY CLOTH SHEETS GR 240	10	355849	23	381.00	HINGE BORING BIT 30MM	10	381008	40
355.86	6 EMERY CLOTH SHEETS ASS.	10	355863	23	382.00	HINGE BORING BIT 35MM	10	382005	40
355.90	PAPER ROLL 5M GR. 50	2	355900	24	383.00	HINGE BORING BIT 38MM	10	383002	40
355.92	PAPER ROLL 5M GR. 80	2	355924	24	384.00	BORING BIT CARBIDE TIPPED 26MM	5	384009	40
355.94	PAPER ROLL 5M GR.120	2	355948	24	384.10	BORING BIT CARBIDE TIPPED 30MM	5	384108	40
355.96	VELCRO PAPER ROLL 3M GR. 50	2	355962	24	384.20	BORING BIT CARBIDE TIPPED 35MM	5	384207	40
355.97	VELCRO PAPER ROLL 3M GR. 80	2	355979	24	384.50	FLAT WOOD DRILL BIT 6MM	10	384504	41
355.98	VELCRO PAPER ROLL 3M GR.120	2	355986	24	385.00	FLAT WOOD DRILL BIT 8MM	10	385006	41
356.00	10 SANDING SHEETS 93X230 50	10	356006	24	386.00	FLAT WOOD DRILL BIT 10MM	10	386003	41
356.01	25 SANDING SHEETS 93X230 50	1	356013	24	387.00	FLAT WOOD DRILL BIT 12MM	10	387000	41
356.10	10 SANDING SHEETS 93X230 80	10	356105	24	388.00	FLAT WOOD DRILL BIT 14MM	10	388007	41
356.11	25 SANDING SHEETS 93X230 80	1	356112	24	389.00	FLAT WOOD DRILL BIT 16MM	10	389004	41
356.20	10 SANDING SHEETS 93X230 120	10	356204	24	390.00	FLAT WOOD DRILL BIT 18MM	10	390000	41
356.21	25 SANDING SHEETS 93X230 120	1	356211	24	391.00	FLAT WOOD DRILL BIT 20MM	10	391007	41
356.30	10 SANDING SHEETS 93X230 ASS	10	356303	24	392.00	FLAT WOOD DRILL BIT 22MM	10	392004	41
356.31	25 SANDING SHEETS 93X230 ASS	1	356310	24	392.50	FLAT WOOD DRILL BIT 24MM	10	392509	41
357.00	10 SANDING SHEETS 115X280 50	10	357003	24	393.00	FLAT WOOD DRILL BIT 25MM	10	393001	41
357.01	25 SANDING SHEETS 115X280 50	1	357010	24	393.20	FLAT WOOD DRILL BIT 26MM	10	393209	41
357.10	10 SANDING SHEETS 115X280 80	10	357102	24	393.40	FLAT WOOD DRILL BIT 28MM	10	393407	41
357.11	25 SANDING SHEETS 115X280 80	1	357119	24	393.60	FLAT WOOD DRILL BIT 30MM	10	393605	41
357.20	10 SANDING SHEETS 115X280 120	10	357201	24	394.00	FLAT WOOD DRILL BIT 32MM	10	394008	41
357.21	25 SANDING SHEETS 115X280 120	1	357218	24	394.20	FLAT WOOD DRILL BIT 35MM	10	394206	41
357.30	10 SANDING SHEETS 115X280 ASS	10	357300	24	394.40	FLAT WOOD DRILL BIT 38MM	10	394404	41
357.31	25 SANDING SHEETS 115X280 ASS	1	357317	24	394.70	FLAT WOOD DRILL BIT 15/45MM	2	394701	41
357.35	3 SANDING BELTS 533X75 GR. 40	2	357355	28	394.80	FLAT WOOD DRILL BIT 22/76MM	2	394800	41
357.36	3 SANDING BELTS 533X75 GR. 60	2	357362	28	394.84	EXTENSION SHANK 150MM	5	394848	41
357.37	3 SANDING BELTS 533X75 GR. 80	2	357379	28	394.86	EXTENSION SHANK 300MM	5	394862	41
357.38	3 SANDING BELTS 533X75 GR.100	2	357386	28	395.00	KNIFE-SCISSOR SHARPENER	10	395005	31
357.39	3 SANDING BELTS 533X75 GR.150	2	357393	28	395.20	SHARPENING STONE	10	395203	31
357.40	3 SANDING BELTS 410X65 GR. 40	3	357409	28	395.40	SHARPENING STONE BULK	10	395401	31
357.45	3 SANDING BELTS 410X65 GR. 60	3	357454	28	396.00	100 MOUNTED GRINDING POINTS	1	396002	31
357.50	3 SANDING BELTS 410X65 GR. 80	3	357508	28	397.00	45 MOUNTED GRINDING POINTS	1	397009	31
357.55	3 SANDING BELTS 410X65 GR.100	3	357553	28	397.20	48 MOUNTED GRINDING POINTS 3MM	1	397207	31
357.57	3 SANDING BELTS 410X65 GR.150	3	357577	28	397.30	48 MOUNTED GRINDING POINTS 3MM	1	397306	31
357.60	3 SANDING BELTS 510X75 GR. 40	2	357607	28	397.60	3 CHAIN SAWS SHARPENING POINTS	10	397603	31
357.65	3 SANDING BELTS 510X75 GR. 60	2	357652	28	398.00	5 MOUNTED GRINDING POINTS 3MM	10	398006	31
357.70	3 SANDING BELTS 510X75 GR. 80	2	357706	28	399.00	5 MOUNTED GRINDING POINTS 6MM	10	399003	31
357.75	3 SANDING BELTS 510X75 GR.100	2	357751	28	400.00	GRINDING WHEEL 75X10X10MM A96	10	400006	34
357.77	3 SANDING BELTS 510X75 GR.150	2	357775	28	402.00	GRINDING WHEEL 75X10X13MM A96	10	402000	34
357.78	3 SANDING BELTS 457X75 GR. 40	2	357782	28	403.00	GRINDING WHEEL 75X10X10MM C49	10	403007	34
357.79	3 SANDING BELTS 457X75 GR. 60	2	357799	28	404.00	GRINDING WHEEL 100X12X13MM A96	10	404004	34
357.80	3 SANDING BELTS 457X75 GR. 80	2	357805	28	404.50	GRINDING WHEEL 125X15X16MM A96	10	404509	34
357.81	3 SANDING BELTS 457X75 GR.100	2	357812	28	405.00	GRINDING WHEEL 150X20X16MM A96	10	405001	34
357.82	3 SANDING BELTS 457X75 GR.150	2	357829	28	406.00	IRON CUTTING DISC 125X2,5X13	10	406008	34
357.96	DRUM SANDER 45X30X6	10	357966	29	406.95	IRON CUTTING DISC 115X1,0X22	10	406954	34
357.98	3 SANDING BELTS ASS. 357.96	10	357980	29	407.00	IRON CUTTING DISC 115X1,6X22	10	407005	34
358.00	FLAP SANDING DISC 115 NYLON 80	10	358000	30	407.05	IRON CUTTING DISC 115X1,6X22	10	407050	34
358.05	FLAP SANDING DISC 180 NYLON 80	10	358055	30	408.00	STONE CUTTING DISC 1			

INDEX: REFERENCES, QUANTITIES AND BAR CODES

Place number 8011017 before EAN code

ref.	description	☐	ean	page	ref.	description	☐	ean	page
413.00	IRON CUTTING DISC 115X3,2X22	10	413006	35	462.50	DOUBLE ENDED BIT 1,2X7,2 + PH3	10	462509	47
413.05	IRON CUTTING DISC 115X3,2X22	10	413051	35	463.00	ASSORTED BIT SET 7 PCS	5	463001	47
413.50	STONE CUTTING DISC 115X3,2X22	10	413501	35	463.50	ASSORTED BIT SET 7 PCS - TORX	5	463506	47
413.55	STONE CUTTING DISC 115X3,2X22	10	413556	35	464.00	ASSORTED BIT SET 10 PCS	5	464008	47
414.00	IRON GRINDING DISC 115X6,4X22	10	414003	35	465.02	HSS DRILL BIT 2MM HEX.SHANK	10	465029	88
414.05	IRON GRINDING DISC 115X6,4X22	10	414058	35	465.03	HSS DRILL BIT 3MM HEX.SHANK	10	465036	88
414.50	STONE GRINDING DISC 115X6.4X22	10	414508	35	465.04	HSS DRILL BIT 4MM HEX.SHANK	10	465043	88
414.55	STONE GRINDING DISC 115X6,4X22	10	414553	35	465.05	HSS DRILL BIT 5MM HEX.SHANK	10	465050	88
418.00	IRON CUTTING DISC 230X3,2X22	25	418001	35	466.00	CONICAL WHEEL BRUSH 90MM	10	466002	48
418.10	STONE CUTTING DISC 230X3,2X22	25	418100	35	466.01	20 CONICAL WHEEL BRUSHES 90MM	1	466019	48
419.60	UNIV.DIAMOND DISC TURBO 115MM	1	419602	38	467.00	CONICAL WHEEL BRUSH 90MM	10	467009	48
419.65	UNIV.DIAMOND DISC TURBO 230MM	1	419657	38	467.01	20 CONICAL WHEEL BRUSHES 90MM	1	467016	48
419.70	SEGMENTED DIAMOND DISC 115MM	1	419701	38	468.00	CONICAL WHEEL BRUSH 120MM	10	468006	48
419.75	SEGMENTED DIAMOND DISC 230MM	1	419756	38	468.01	20 CONICAL WHEEL BRUSHES 120MM	1	468013	48
419.80	DIAMOND DISC CONTIN.EDGE 115MM	1	419800	38	468.20	CONICAL WHEEL BRUSH 150MM	5	468204	48
419.85	DIAMOND DISC CONTIN.EDGE 230MM	1	419855	38	468.30	TWIS.CONIC.WHEEL BRUSH 100MM	5	468303	48
419.90	WOOD CUTTING DISC 115M	5	419909	38	468.35	TWIS.CONIC.WHEEL BRUSH 120MM	5	468358	48
419.95	WOOD CUTTING DISC 230M	1	419954	38	468.40	TWIS.CONIC.WHEEL BRUSH 150MM	5	468402	48
420.00	CYLINDRICAL ROTARY FILE	10	420004	43	468.50	WHEEL BRUSH 40MM	10	468501	49
422.00	CONICAL ROTARY FILE	10	422008	43	468.51	20 WHEEL BRUSHES 40MM	1	468518	49
424.00	CYLINDRICAL ROUNDED FILE	10	424002	43	469.00	WHEEL BRUSH 50MM	10	469003	49
426.00	SPHERICAL ROTARY FILE	10	426006	43	469.01	20 WHEEL BRUSHES 50MM	1	469010	49
43.034	REDUCING COLLAR 43X34MM	1	430348	86	470.00	WHEEL BRUSH 75MM	10	470009	49
43.037	REDUCING COLLAR 43X37MM	1	430379	86	470.01	20 WHEEL BRUSHES 75MM	1	470016	49
43.038	REDUCING COLLAR 43X38MM	1	430386	86	470.50	WHEEL BRUSH 75MM D.THICK	10	470504	49
43.384	REDUCING COLLAR 43X38,4MM	1	433844	86	475.00	WHEEL BRUSH 100MM	10	475004	49
430.00	CYLINDRICAL ROTARY RASP	10	430003	43	475.01	20 WHEEL BRUSHES 100MM	1	475011	49
432.00	CONICAL ROTARY RASP	10	432007	43	475.50	WHEEL BRUSH 100MM D.THICK	10	475509	49
434.00	SPHERICAL ROTARY RASP	10	434001	43	475.65	TWISTED WHEEL BRUSH 75MM	5	475653	49
436.00	DOME ROTARY RASP	10	436005	43	475.70	TWISTED WHEEL BRUSH 100MM	5	475707	49
438.00	ROTARY COUNTERSINK	10	438009	43	476.00	3 ASSORTED MINI BRUSHES	10	476001	50
440.00	WOOD DRILL SAW 6X90MM	10	440002	43	477.00	END BRUSH 16MM	10	477008	50
440.20	CONICAL ROTARY RASP HEX. SHANK	5	440200	43	477.01	20 END BRUSHES 16MM	1	477015	50
440.40	DOME ROTARY RASP HEX. SHANK	5	440408	43	478.00	END BRUSH 25MM	10	478005	50
445.00	METAL/WOOD DRILL FILE 6X85MM	10	445007	43	478.01	20 END BRUSHES 25MM	1	478012	50
445.20	CONICAL ROTARY FILE HEX. SHANK	5	445205	43	478.20	END BRUSH 30MM MUSHROOM	10	478203	50
445.30	DOME ROTARY FILE HEX. SHANK	5	445304	43	478.40	END BRUSH 40MM MUSHROOM	10	478401	50
446.00	SET 3 MINI ROTARY RASPS/FILES	10	446004	43	478.80	SPIRAL BRUSH 16MM	10	478807	50
447.00	SET 6 ROTARY RASPS/FILES	5	447001	43	478.90	SPIRAL BRUSH 20MM	10	478906	50
448.00	WOOD RASP 10/15MM	10	448008	44	479.00	SPIRAL BRUSH 28MM	10	479002	50
448.10	WOOD RASP 15/20MM	10	448107	44	479.01	20 SPIRAL BRUSHES 28MM	1	479019	50
448.20	WOOD RASP 20/25MM	10	448206	44	479.10	SPIRAL BRUSH 38MM	10	479101	50
449.06	FLAT FILE/RASP 150MM - 6"	10	449067	44	480.00	CUP BRUSH 50MM	10	480008	51
449.08	FLAT FILE/RASP 200MM - 8"	10	449081	44	480.01	20 CUP BRUSHES 50MM	1	480015	51
449.20	SET 6 ASSORTED FILES 100MM	5	449203	44	485.00	CUP BRUSH 70MM	10	485003	51
449.40	2 ROUND CHAIN SAW FILES 5/32"	10	449401	44	485.01	20 CUP BRUSHES 70MM	1	485010	51
449.45	12 ROUND CHAIN SAW FILES 5/32"	2	449456	44	485.20	CUP BRUSH 85MM	10	485201	51
449.50	2 ROUND CHAIN SAW FILES 3/16"	10	449500	44	485.21	20 CUP BRUSHES 85MM	1	485218	51
449.55	12 ROUND CHAIN SAW FILES 3/16"	2	449555	44	485.30	CUP BRUSH 60MM M14	10	485300	51
449.60	2 ROUND CHAIN SAW FILES 7/32"	10	449609	44	485.31	20 CUP BRUSHES 60MM M14	1	485317	51
449.65	12 ROUND CHAIN SAW FILES 7/32"	2	449654	44	485.40	CUP BRUSH 85MM M14	10	485409	51
451.00	HAND COUNTERSINK	10	451008	40	485.41	20 CUP BRUSHES 85MM M14	1	485416	51
451.10	COUNTERSINK 10MM HEXAG.SHANK	5	451107	40	485.50	CUP BRUSH 100MM M14	5	485508	51
451.20	COUNTERSINK 13MM HEXAG.SHANK	5	451206	40	485.51	10 CUP BRUSHES 100MM M14	1	485515	51
451.30	COUNTERSINK 16MM HEXAG.SHANK	5	451305	40	485.60	CUP BRUSH 120MM M14	5	485607	51
452.00	MAGNETIC BIT HOLDER	10	452005	45	485.61	5 CUP BRUSHES 120MM M14	1	485614	51
452.05	MAGNETIC BIT HOLDER QUICK REL.	5	452050	45	485.65	CUP BRUSH 150MM M14	5	485652	51
452.10	MAGNETIC BIT HOLDER-DEPTH STOP	5	452104	45	485.70	TWIS. CUP BRUSH 75MM M14	5	485706	51
452.15	FLEXIBLE BIT HOLDER 190MM	5	452159	45	485.75	TWIS. CUP BRUSH 85MM M14	5	485751	51
452.20	BIT HOLDER SDS ATTACHMENT	5	452203	45	485.76	TWIS. CUP BRUSH 100MM M14	1	485768	51
452.30	90° ANGLE SCREWDRIVER	5	452302	45	485.77	TWIS. CUP BRUSH 120MM M14	1	485775	51
452.40	2 TORX BITS 10	10	452401	45	485.80	WHEEL BRUSH 75X13MM	10	485805	49
452.50	2 TORX BITS 15	10	452500	45	486.00	WHEEL BRUSH 100X13MM	10	486000	49
452.60	2 TORX BITS 20	10	452609	45	487.00	WHEEL BRUSH 120X16MM	10	487007	49
452.70	2 TORX BITS 25	10	452708	45	488.00	WHEEL BRUSH 150X16MM	10	488004	49
452.80	2 TORX BITS 30	10	452807	45	489.00	WHEEL BRUSH 200X20X20MM	1	489001	49
452.90	2 TORX BITS 40	10	452906	45	489.50	WHEEL BRUSH 200X40X20MM	3	489506	49
452.92	2 TIN TORX BITS 10	5	452920	45	490.00	BRASS WHEEL BRUSH 75MM	10	490007	48
452.93	2 TIN TORX BITS 15	5	452937	45	495.00	BRASS CUP BRUSH 50MM	10	495002	48
452.94	2 TIN TORX BITS 20	5	452944	45	496.00	40 ASSORTED STEEL BRUSHES	1	496009	53
452.95	2 TIN TORX BITS 25	5	452951	45	496.50	30 ASSORTED NYLON BRUSHES	1	496504	53
452.96	2 TIN TORX BITS 30	5	452968	45	496.82	MINI STEEL HAND BRUSH	12	496825	55
452.97	2 TIN TORX BITS 40	5	452975	45	496.84	MINI S/STEEL HAND BRUSH	12	496849	55
453.00	2 ALLEN KEY BITS 2MM	10	453002	46	496.85	MINI BRASS HAND BRUSH	12	496912	55
453.10	2 ALLEN KEY BITS 2.5MM	10	453101	46	496.88	MINI NYLON HAND BRUSH	12	496887	55
453.20	2 ALLEN KEY BITS 3MM	10	453200	46	496.90	24 ASSORTED HAND BRUSHES	1	496900	53
453.30	2 ALLEN KEY BITS 4MM	10	453309	46	496.93	NYLON HAND BRUSH	24	496931	54
453.40	2 ALLEN KEY BITS 5MM	10	453408	46	496.96	BRASS HAND BRUSH	24	496962	54
453.50	2 ALLEN KEY BITS 6MM	10	453507	46	496.99	S/STEEL HAND BRUSH	24	496993	54
454.00	2 PHILLIPS BITS N.1	10	454009	46	497.00	STEEL HAND BRUSH	24	497006	54
455.00	2 PHILLIPS BITS N.2	10	455006	46	497.02	KIT 5 ASSORTED STEEL BRUSHES	3	497020	56
456.00	2 PHILLIPS BITS N.3	10	456003	46	497.04	KIT 4 ASSORTED STEEL BRUSHES	10	497044	56
456.20	PHILLIPS BIT N.4	10	456201	46	497.05	NYLON WHEEL BRUSH 75MM GR. 80	5	497051	52
456.50	2 PHILLIPS TIN BITS 1	5	456508	46	497.10	NYLON WHEEL BRUSH 75MM GR.150	5	497105	52
456.52	2 PHILLIPS TIN BITS 2	5	456522	46	497.15	NYLON WHEEL BRUSH 100MM GR. 80	5	497150	52
456.54	2 PHILLIPS TIN BITS 3	5	456546	46	497.20	NYLON WHEEL BRUSH 100MM GR.150	5	497204	52
457.00	2 SLOT BITS 0,8X4MM	10	457000	46	497.25	NYLON CUP BRUSH 50MM GR. 80	5	497259	52
458.00	2 SLOT BITS 0,8X5MM	10	458007	46	497.30	NYLON CUP BRUSH 50MM GR.150	5	497303	52
459.00	2 SLOT BITS 1,0X6MM	10	459004	46	497.35	NYLON CUP BRUSH 70MM GR. 80	5	497358	52
459.20	2 SLOT BITS 1,2X7,2MM	10	459202	46	497.40	NYLON CUP BRUSH 70MM GR.150	5	497402	52
459.40	2 SLOT BITS 1,6X8MM	10	459400	46	497.45	NYLON END BRUSH 25MM GR. 80	5	497457	52
459.50	2 SLOT TIN BITS 0,8X4 MM	5	459509	46	497.50	NYLON END BRUSH 25MM GR.150	5	497501	52
459.52	2 SLOT TIN BITS 0,8X5 MM	5	459523	46	497.55	NYLON FLAP BRUSH 100MM GR. 80	5	497556	52
459.54	2 SLOT TIN BITS 1,0X6 MM	5	459547	46	497.60	NYLON FLAP BRUSH 100MM GR.150	5	497600	52
459.90	2 POZIDRIV BITS N.0	10	459905	47	498.00	WELDING GOGGLES CE	5	498003	58
460.00	2 POZIDRIV BITS N.1	10	460000	47	498.50	WELDING GOGGLES CE	5	498508	58
460.10	2 POZIDRIV BITS N.2	10	460109	47	498.60	PROFESS. WELDING GOGGLES CE	1	498607	58
460.20	2 POZIDRIV BITS N.3	10	460208	47	50.010	DRILL STAND 43MM	1	500102	86
460.30	POZIDRIV BIT N.4	10	460307	47	50.020	DRILL STAND 43MM	1	500201	86
460.50	2 POZIDRIV TIN BITS 0	5	460505	47	50.030	DRILL STAND 60MM	1	500300	86
460.52	2 POZIDRIV TIN BITS 1	5	460529	47	50.040	DRILL STAND 60MM	1	500409	86
460.54	2 POZIDRIV TIN BITS 2	5	460543	47	50.060	ANGLE GRINDER STAND 230MM	1	500607	85
460.56	2 POZIDRIV TIN BITS 3	5	460567	47	50.080	ANGLE GRINDER STAND 230MM	1	500805	85
461.00	DOUBLE ENDED BIT 0,8X4 + PH1	10	461007	47	50.090	ANGLE GRINDER STAND 115MM	1	500904	85
462.00	DOUBLE ENDED BIT 0,8X5 + PH2	10	462004	47	500.00	PROFESSIONAL SAFETY GLASSES CE	1	500003	58

INDEX: REFERENCES, QUANTITIES AND BAR CODES

Place number 8011017 before EAN code

ref.	description	☐	ean	page	ref.	description	☐	ean	page
500.25	PROFESSIONAL SAFETY GLASSES CE	1	500256	58	600.00	12 GLUE STICKS 7X100MM	10	600000	80
500.35	PROFESSIONAL SAFETY GLASSES CE	1	500355	58	600.20	12 GLUE STICKS 11X100MM	10	600208	80
501.00	SAFETY GLASSES	5	501000	58	601.00	TACKER	1	601007	67
501.20	SAFETY GLASSES CE	1	501208	58	604.00	ADJUSTABLE TACKER METAL BODY	1	604008	67
501.40	SAFETY GLASSES CE	1	501406	58	607.30	5000 STAPLES 6MM	5	607306	67
501.60	PROFESSIONAL SAFETY GLASSES CE	1	501604	58	607.35	1000 STAPLES 6MM	10	607351	67
502.00	5 PROTECTION MASKS	10	502007	59	607.40	5000 STAPLES 8MM	5	607405	67
502.50	50 PROTECTION MASKS	1	502502	59	607.45	1000 STAPLES 8MM	10	607450	67
502.60	2 PROTECTION MASKS CE	10	502601	59	607.50	5000 STAPLES 10MM	5	607504	67
502.70	2 PROTECTION MASKS CE	5	502700	59	607.55	1000 STAPLES 10MM	10	607559	67
503.00	REINFORCED PROTECTION MASK	10	503004	59	607.60	5000 STAPLES 12MM	5	607603	67
504.00	RESPIRATOR WITH CARTRIDGE DUST	5	504001	59	607.65	1000 STAPLES 12MM	10	607658	67
504.20	REPLACEMENT DUST FILTER	5	504209	59	607.70	5000 STAPLES 14MM	5	607702	67
504.40	REPLACEMENT GAS FILTER	5	504407	59	607.75	1000 STAPLES 14MM	10	607757	67
504.50	RESPIRATOR WITH FILTER A1 CE	1	504506	59	611.10	TAPE-RULE MEASURE 3M	12	611105	68
504.55	REPLACEMENT FILTER A1 CE	2	504551	59	611.20	TAPE-RULE MEASURE 5M	6	611204	68
504.58	REPLACEMENT FILTER P3 CE	2	504582	59	611.25	24 TAPE-RULE MEASURES 5M	1	611259	68
504.70	RESPIRATOR 2 FILTERS A1 CE	1	504704	60	611.30	TAPE-RULE MEASURE 8M	4	611303	68
504.75	REPLACEMENT FILTER A1 CE	2	504759	60	620.00	3 DEPTH STOP RINGS 6-8-10MM	10	620008	70
504.78	REPLACEMENT FILTER P3 CE	2	504780	60	620.10	DEPTH STOP RING 12MM	10	620107	70
505.00	EAR PROTECTOR	5	505008	60	620.20	DEPTH STOP RING 14MM	10	620206	70
505.20	EAR PROTECTOR CE	1	505206	60	624.00	WOODEN PLANE 36MM	1	624006	66
505.40	PROFESSIONAL EAR PROTECTOR CE	1	505404	60	624.10	IRON 36MM FOR ART.624.00	1	624105	66
505.50	HEALTH AND SAFETY KIT 4 PCS	1	505503	60	625.00	WOODEN PLANE 45MM	1	625003	66
505.80	3 PAIRS EAR PLUGS CE	10	505800	60	625.10	IRON 45MM FOR ART.625.00	1	625102	66
505.83	5 PAIRS EAR PLUGS DOUBLE LAYER	10	505831	60	626.00	WOODEN PLANE 48MM	1	626000	66
505.86	1 PAIR EAR PLUGS TRIPLE FLANGE	10	505862	60	626.10	IRON 48MM FOR ART.626.00	1	626109	66
506.10	50 NITRILE GLOVES H.D. "M" CE	1	506104	61	628.00	WOODEN REBATE PLANE 24MM	1	628004	66
506.11	50 NITRILE GLOVES H.D. "L" CE	1	506111	61	628.10	IRON 24MM FOR ART.628.00	1	628103	66
506.12	50 NITRILE GLOVES H.D. "XL" CE	1	506128	61	629.00	WOODEN REBATE PLANE 27MM	1	629001	66
506.15	100 NITRILE GLOVES "M" CE	1	506159	61	629.10	IRON 27MM FOR ART.629.00	1	629100	66
506.16	100 NITRILE GLOVES "L" CE	1	506166	61	629.85	2 BLADES ELEC.PLANERS 75,5X5,5	5	629858	66
506.17	100 NITRILE GLOVES "XL" CE	1	506173	61	629.87	2 BLADES ELEC.PLANERS 80,5X5,9	5	629872	66
506.50	RUBBER KNEE PADS	1	506500	61	629.89	2 BLADES ELEC.PLANERS 82,0X5,5	5	629896	66
506.60	SAFETY HELMET CE	1	506609	61	629.93	2 BLADES ELEC.PLANERS 102X5,5	5	629933	66
507.00	MIXING PADDLE 80X400MM	5	507002	62	630.03	WOOD DRILL BIT 3MM	10	630038	90
508.00	MIXING PADDLE 100X500MM	2	508009	62	630.04	WOOD DRILL BIT 4MM	10	630045	90
509.00	MIXING PADDLE 120X600MM	2	509006	62	630.05	WOOD DRILL BIT 5MM	10	630052	90
509.40	MIXING PADDLE 130X600MM	2	509402	62	630.06	WOOD DRILL BIT 6MM	10	630069	90
510.00	MIXING PADDLE 60X350MM	10	510002	62	630.07	WOOD DRILL BIT 7MM	10	630076	90
511.00	MIXING PADDLE 60X400MM	5	511009	62	630.08	WOOD DRILL BIT 8MM	10	630083	90
512.00	MIXING PADDLE 80X400MM	5	512006	62	630.09	WOOD DRILL BIT 9MM	10	630090	90
513.00	MIXING PADDLE 100X600MM	2	513003	62	630.10	WOOD DRILL BIT 10MM	10	630106	90
514.00	MIXING PADDLE 120X600MM	2	514000	62	630.11	WOOD DRILL BIT 11MM	10	630113	90
514.10	MIXING PADDLE 125X600MM D.HEL	2	514109	62	630.12	WOOD DRILL BIT 12MM	10	630120	90
550.00	FLEXIBLE SHAFT 90CM	1	550008	79	630.13	WOOD DRILL BIT 13MM	10	630137	90
550.06	CHUCK 6MM FOR FLEXIBLE SHAFT	1	550060	79	630.14	WOOD DRILL BIT 14MM	10	630144	90
555.00	FLEXIBLE SHAFT 130CM	1	555003	79	649.00	CARPENTER PENCIL 180MM	144	009407	69
555.08	CHUCK 8MM FOR FLEXIBLE SHAFT	1	555089	79	649.06	6 CARPENTER PENCILS 180MM	5	649061	69
560.00	FLEXIBLE SHAFT 130CM PROFESS.	1	560007	79	650.00	DOWELLING JIG	1	650005	69
565.00	DUST CATCHER 4/10MM	10	565002	87	655.00	100 WOODEN DOWELS 6X30MM	10	655000	69
566.00	METAL AUTOMATIC-SAFETY KNIFE	4	566009	63	655.05	1000 WOODEN DOWELS 6X30MM	1	655055	69
566.05	PROFESSIONAL KNIFE + 5 BLADES	4	566054	63	660.00	60 WOODEN DOWELS 8X35MM	10	660004	69
566.11	CUTTER 5 BLADES - SELF LOADING	2	566115	63	660.05	1000 WOODEN DOWELS 8X35MM	1	660059	69
566.12	PROFESSIONAL CUTTER 25MM	12	566122	63	665.00	40 WOODEN DOWELS 10X40MM	10	665009	69
566.14	PROFES. CUTTER 9MM + 3 BLADES	24	566146	63	665.05	1000 WOODEN DOWELS 10X40MM	1	665054	69
566.16	PROFES. CUTTER 18MM + 3 BLADES	24	566160	63	666.00	30 WOODEN DOWELS 12X40MM	10	666006	69
566.17	CUTTER 9MM/3 BLADES SELF-LOAD	12	566177	63	666.05	500 WOODEN DOWELS 12X40MM	1	666051	69
566.18	CUTTER 18MM/3 BLADES SELF-LOAD	12	566184	63	668.00	100 WOODEN DOWELS 6X1000MM	1	668000	69
566.20	CUTTER 9MM METAL BODY	24	566207	63	668.10	100 WOODEN DOWELS 8X1000MM	1	668109	69
566.23	CUTTER 9MM ABS BODY	24	566238	63	668.20	100 WOODEN DOWELS 10X1000MM	1	668208	69
566.25	CUTTER 9MM METAL GUIDE	24	566252	63	668.30	50 WOODEN DOWELS 12X1000MM	1	668307	69
566.30	CUTTER 9MM ABS TRASP. BODY	24	566306	64	668.40	40 WOODEN DOWELS 14X1000MM	1	668406	69
566.40	CUTTER 18MM ABS TRASP. BODY	24	566405	64	668.50	40 WOODEN DOWELS 16X1000MM	1	668505	69
566.50	CUTTER 18MM METAL GUIDE	24	566504	64	669.00	50 JOINTING BISCUITS T. 0	10	669007	70
566.60	CUTTER 18MM METAL GUIDE	24	566603	64	669.05	1000 JOINTING BISCUITS T. 0	1	669052	70
567.00	SCRAPER WITH ADJUSTABLE BLADE	24	567006	64	669.10	50 JOINTING BISCUITS T.10	10	669106	70
568.00	5 MEDIUM HEAVY DUTY BLADES	12	568003	64	669.15	1000 JOINTING BISCUITS T.10	1	669151	70
568.10	5 LARGE HEAVY DUTY BLADES	12	568102	64	669.20	50 JOINTING BISCUITS T.20	10	669205	70
568.20	5 HOOK BLADES	12	568201	64	669.25	1000 JOINTING BISCUITS T.20	1	669250	70
568.30	10 CUTTER BLADES 9MM	12	568300	64	670.00	4 CENTER POINTS 6MM	10	670003	70
568.40	10 CUTTER BLADES 18MM	12	568409	64	675.00	4 CENTER POINTS 8MM	10	675008	70
568.50	5 CUTTER BLADES 25MM	12	568508	64	680.00	4 CENTER POINTS 10MM	10	680002	70
569.00	GLASS CUTTER	5	569000	64	680.10	4 CENTER POINTS 12MM	10	680101	70
570.00	SET 5 WOOD CARVING TOOLS	2	570006	65	680.20	2 CENTER POINTS 14MM	10	680200	70
572.00	SET 6 WOOD CARVING TOOLS	2	572000	65	681.00	DOWELLING KIT 6MM	5	681009	70
575.00	FLAT CHISEL 6MM	5	575001	65	682.00	DOWELLING KIT 8MM	5	682006	70
576.00	FLAT CHISEL 8MM	5	576008	65	683.00	DOWELLING KIT 10MM	5	683003	70
577.00	FLAT CHISEL 10MM	5	577005	65	684.00	3 HSS JIGSAW BLADES B&D	10	684000	71
578.00	FLAT CHISEL 12MM	5	578002	65	685.00	3 HSS JIGSAW BLADES B&D	10	685007	71
579.00	FLAT CHISEL 14MM	5	579009	65	686.00	3 HSS JIGSAW BLADES B&D	10	686004	71
580.00	FLAT CHISEL 16MM	5	580005	65	686.50	3 HSS JIGSAW BLADES B&D 80MM	10	686509	71
581.00	FLAT CHISEL 18MM	5	581002	65	687.00	3 CV JIGSAW BLADES B&D	10	687001	71
582.00	FLAT CHISEL 20MM	5	582009	65	688.00	3 CV JIGSAW BLADES B&D	10	688008	71
583.00	FLAT CHISEL 26MM	5	583006	65	689.00	3 CV JIGSAW BLADES B&D	10	689005	71
584.00	FLAT CHISEL 30MM	5	584003	65	689.10	3 CV JIGSAW GROUN. BLADES B&D	10	689104	71
585.00	FLAT CHISEL 32MM	5	585000	65	689.20	3 CV JIGSAW GROUN. BLADES B&D	10	689203	71
586.00	FLAT CHISEL 40MM	5	586007	65	689.50	3 CV JIGSAW BLADES B&D 100MM	10	689500	71
590.00	WOOD GIMLET 2MM	10	590004	65	694.00	3 HSS JIGSAW BLADES BOSCH	10	694009	72
591.00	WOOD GIMLET 3MM	10	591001	65	695.00	3 HSS JIGSAW BLADES BOSCH	10	695006	72
592.00	WOOD GIMLET 4MM	10	592008	65	696.00	3 HSS JIGSAW BLADES BOSCH	10	696003	72
593.00	WOOD GIMLET 5MM	10	593005	65	696.50	3 HSS JIGSAW BLADES BOSCH 80MM	10	696508	72
594.00	WOOD GIMLET 6MM	10	594002	65	697.00	3 CV JIGSAW BLADES BOSCH	10	697000	72
595.00	WOOD GIMLET 8MM	10	595009	65	698.00	3 CV JIGSAW BLADES BOSCH	10	698007	72
597.00	WOOD GIMLETS 2-3-4MM	10	597003	65	699.00	3 CV JIGSAW BLADES BOSCH	10	699004	72
598.00	TACK-LIFTER 190MM	10	598000	66	699.10	3 CV JIGSAW GROUN.BLADES BOSCH	10	699103	72
598.50	MARKING PEN CARBIDE TIPPED	5	598505	80	699.20	3 CV JIGSAW GROUN. BLADES BOSCH	10	699202	72
599.00	GLUE GUN 20W-7MM	1	599007	80	699.50	3 CV JIGSAW BLADES BOSCH 100MM	10	699509	72
599.20	GLUE GUN 40W-11MM	1	599205	80	699.60	2 CV JIGSAW BLADES BOSCH 220MM	10	699399	72
60.043	REDUCING COLLAR 60X43MM	1	600437	86	704.00	3 HSS JIGSAW BLADES BOSCH	10	704005	73
60.046	REDUCING COLLAR 60X46MM	1	600468	86	705.00	3 HSS JIGSAW BLADES BOSCH	10	705002	73
60.050	REDUCING COLLAR 60X50MM	1	600505	86	706.00	3 HSS JIGSAW BLADES BOSCH	10	706009	73
60.053	REDUCING COLLAR 60X53MM	1	600536	86	707.00	3 CV JIGSAW BLADES BOSCH	10	707006	73
60.054	REDUCING COLLAR 60X54MM	1	600543	86	708.00	3 CV JIGSAW BLADES BOSCH	10	708003	73
60.056	REDUCING COLLAR 60X56MM	1	600567	86	714.00	3 HSS JIGSAW BLADES MAKITA	10	714004	73

INDEX: REFERENCES, QUANTITIES AND BAR CODES

Place number 8011017 before EAN code

ref.	description	☒	ean	page	ref.	description	☒	ean	page
715.00	3 HSS JIGSAW BLADES MAKITA	10	715001	73	835.00	HSS ENLARGING CUTTER 0/25MM	5	835006	12
716.00	3 HSS JIGSAW BLADES MAKITA	10	716008	73	835.50	HSS ENLARGING CUTTER 6/32MM	1	835501	12
717.00	3 CV JIGSAW BLADES MAKITA	10	717005	73	835.60	HSS ENLARGING CUTTER 6/45MM	1	835600	12
718.00	3 CV JIGSAW BLADES MAKITA	10	718002	73	840.00	HSS COUNTERSINK 12MM	5	840000	12
719.00	3 CV JIGSAW BLADES MAKITA	10	719009	73	845.00	HSS COUNTERSINK 16MM	5	845005	12
720.00	3 CV JIGSAW BLADES B&D	10	720005	71	850.00	HSS COUNTERSINK 20MM	5	850009	12
720.50	2 CV JIGSAW BLADES B&D 115MM	5	720500	71	880.00	WET GRINDING WHEEL 100X20X16	1	880006	80
720.90	10 ASSORTED B&D JIG SAW BLADES	3	720906	71	882.00	GRINDING WHEEL FOR ART.880.00	1	882000	80
721.00	3 CV JIGSAW BLADES BOSCH	10	721002	72	890.00	DRILL POWERED WATER PUMP	5	890005	80
721.50	2 CV JIGSAW BLADES BOSCH 115MM	5	721507	72	921.00	6MM HAND DRILL	5	921006	81
721.90	10 ASS. BOSCH JIG SAW BLADES	3	721903	72	924.00	8MM HAND DRILL	1	924007	81
722.00	3 CV JIGSAW BLADES MAKITA	10	722009	73	928.00	13MM HAND DRILL	1	928005	81
724.00	TUNGSTEN CARBIDE BLADE B&D	5	724003	71	930.00	CHUCK 6MM FOR HAND DRILL	1	930008	81
725.00	TUNGSTEN CARBIDE BLADE BOSCH	5	725000	72	932.00	CHUCK 8MM FOR HAND DRILL	1	932002	81
728.00	GLASS DRILL BIT 3MM	5	728001	87	936.00	CHUCK 13MM FOR HAND DRILL	1	936000	81
728.10	GLASS DRILL BIT 4MM	5	728100	87	946.00	8 HEXAGONAL KEY WRENCHES	10	946009	81
728.20	GLASS DRILL BIT 5MM	5	728209	87	946.50	10 HEXAGONAL KEY WRENCHES	10	946504	81
728.30	GLASS DRILL BIT 6MM	5	728308	87	947.00	8 TORX KEY WRENCHES	10	947006	81
728.40	GLASS DRILL BIT 8MM	5	728407	87	948.00	CARPENTERS CLAMP 150MM	6	948003	82
728.50	GLASS DRILL BIT 10MM	5	728506	87	948.10	CARPENTERS CLAMP 200MM	6	948102	82
728.60	GLASS DRILL BIT 12MM	5	728605	87	948.20	CARPENTERS CLAMP 250MM	6	948201	82
728.80	GLASS DRILL BIT 3MM HEX.SHANK	5	728803	87	948.30	CARPENTERS CLAMP 300MM	6	948300	82
728.81	GLASS DRILL BIT 4MM HEX.SHANK	5	728810	87	948.40	CARPENTERS CLAMP 400MM	4	948409	82
728.82	GLASS DRILL BIT 5MM HEX.SHANK	5	728827	87	948.50	CARPENTERS CLAMP 500MM	4	948508	82
728.83	GLASS DRILL BIT 6MM HEX.SHANK	5	728834	87	948.60	CARPENTERS CLAMP 600MM	4	948607	82
728.85	GLASS DRILL BIT 8MM HEX.SHANK	5	728858	87	948.65	CARPENTERS CLAMP 700MM	2	948652	82
728.87	GLASS DRILL BIT 10MM HEX.SHANK	5	728872	87	948.70	CARPENTERS CLAMP 800MM	2	948706	82
728.89	GLASS DRILL BIT 12MM HEX.SHANK	5	728896	87	948.80	CARPENTERS CLAMP 1000MM	2	948805	82
730.00	HOLE SAW 25/62MM 25MM	10	730004	74	948.82	CARPENTERS CLAMP 1200MM	2	948829	82
732.00	HOLE SAW 25/62MM 50MM	10	732008	74	948.84	CARPENTERS CLAMP 1500MM	2	948843	82
735.00	HOLE SAW 60/95MM 40MM	5	735009	74	948.86	CARPENTERS CLAMP 2000MM	2	948867	82
740.00	C.V.CIRC.SAW BLADE 125X20 T.24	5	740003	76	948.88	CARPENTERS CLAMP 2500MM	2	948881	82
745.00	C.V.CIRC.SAW BLADE 125X20 T.80	5	745008	76	948.90	CARPENTERS CLAMP 3000MM	2	948904	82
750.00	C.V.CIRC.SAW BLADE 150X20 T.24	5	750002	76	948.93	ONE HAND CLAMP 150MM	4	948935	82
755.00	C.V.CIRC.SAW BLADE 150X20 T.80	5	755007	76	948.95	ONE HAND CLAMP 300MM	4	948959	82
756.02	H.M.CIRC.SAW BLADE 125X20 T.18	1	756028	76	948.97	ONE HAND CLAMP 450MM	4	948973	82
756.06	H.M.CIRC.SAW BLADE 140X20 T.18	1	756066	76	949.00	ALUMINIUM "C" CLAMP 80X65MM	1	949000	82
756.10	H.M.CIRC.SAW BLADE 150X20 T.20	1	756103	76	949.10	ALUMINIUM "C" CLAMP 105X75MM	1	949109	82
756.12	H.M.CIRC.SAW BLADE 150X30 T.34	1	756127	76	949.20	ALUMINIUM "C" CLAMP 160X75MM	1	949208	82
756.14	H.M.CIRC.SAW BLADE 160X20 T.24	1	756141	76	949.50	CLAMP 50MM	5	949505	83
756.16	H.M.CIRC.SAW BLADE 160X20 T.36	1	756165	76	949.60	CLAMP 75MM	5	949604	83
756.18	H.M.CIRC.SAW BLADE 170X30 T.18	1	756189	76	949.70	CLAMP 100MM	5	949703	83
756.20	H.M.CIRC.SAW BLADE 170X30 T.36	1	756202	76	951.00	CLAMP 25MM	10	951003	83
756.22	H.M.CIRC.SAW BLADE 180X30 T.22	1	756226	76	952.00	CLAMP 50MM	10	952000	83
756.24	H.M.CIRC.SAW BLADE 180X30 T.36	1	756240	76	953.00	CLAMP 75MM	10	953007	83
756.26	H.M.CIRC.SAW BLADE 180X30 T.52	1	756264	76	954.00	QUICK PRESS VICE 70MM	1	954004	83
756.28	H.M.CIRC.SAW BLADE 190X30 T.30	1	756288	76	955.00	MOBILE CLAMP 90°	1	955001	83
756.30	H.M.CIRC.SAW BLADE 190X30 T.42	1	756301	76	956.00	CORNER CLAMP	5	956008	83
756.32	H.M.CIRC.SAW BLADE 200X30 T.42	1	756325	76	957.00	QUICK ADJUSTING BAND CLAMP 4M	1	957005	84
756.34	H.M.CIRC.SAW BLADE 200X30 T.60	1	756349	76	957.50	RATCHET CLAMP 50MM	5	957500	84
756.36	H.M.CIRC.SAW BLADE 210X30 T.20	1	756363	76	957.70	RATCHET CLAMP 70MM	5	957708	84
756.38	H.M.CIRC.SAW BLADE 210X30 T.30	1	756387	76	958.00	4 MINI SPRING CLAMPS 18MM	10	958002	84
756.40	H.M.CIRC.SAW BLADE 210X30 T.42	1	756400	76	958.05	SPRING CLAMP 30MM	10	958057	84
756.42	H.M.CIRC.SAW BLADE 230X30 T.20	1	756424	76	958.07	SPRING CLAMP 40MM	10	958071	84
756.44	H.M.CIRC.SAW BLADE 230X30 T.34	1	756448	76	958.10	SPRING CLAMP 60MM	10	958101	84
756.46	H.M.CIRC.SAW BLADE 230X30 T.40	1	756462	76	958.14	SPRING CLAMP 70MM	10	958149	84
756.48	H.M.CIRC.SAW BLADE 250X30 T.24	1	756486	76	960.00	ROTARY DRILL CLAMP 43MM	1	960005	85
756.50	H.M.CIRC.SAW BLADE 250X30 T.48	1	756509	76	965.00	WOODTURNING LATHE ATTACHMENT	1	965000	85
756.52	H.M.CIRC.SAW BLADE 250X30 T.60	1	756523	76	970.00	DRILL AND MILL ATTACHMENT 43MM	1	970004	85
756.54	H.M.CIRC.SAW BLADE 300X30 T.48	1	756547	76	972.00	MOBILE DRILL STAND 43MM 0/45°	1	972008	85
756.56	H.M.CIRC.SAW BLADE 300X30 T.72	1	756561	76	A96/C49	GRINDING WHEELS	1	36	
756.58	H.M.CIRC.SAW BLADE 300X30 T.96	1	756585	76	C48/C48	DRESSING STONES	8	37	
756.60	H.M.CIRC.SAW BLADE 350X30 T.84	1	756608	76	DG/DG	GRINDING STONES	4	37	
756.62	H.M.CIRC.SAW BLADE 350X30 T.108	1	756622	76	ESPO.S1	DISPLAYER FOR BRUSHES 134 PCS	1	087450	57
760.00	KEYLESS CHUCK 10MM MALE THR.	1	760001	77	ESPO.S2	DISPLAYER FOR BRUSHES 94 PCS	1	087702	57
762.00	KEYLESS CHUCK 10MM FEMALE THR.	1	762005	77	FC.01	FINISHING PAPER SHEETS GR 40	100	083346	22
764.00	KEYLESS CHUCK 13MM FEMALE THR.	1	764009	77	FC.03	FINISHING PAPER SHEETS GR 60	100	083353	22
766.00	KEYLESS CHUCK 10MM FEMALE THR.	1	766003	77	FC.04	FINISHING PAPER SHEETS GR 80	100	083360	22
768.00	KEYLESS CHUCK 13MM FEMALE THR.	1	768007	77	FC.05	FINISHING PAPER SHEETS GR 100	100	083377	22
773.00	KEYLESS CHUCK 10MM MALE THR.	1	773001	77	FC.06	FINISHING PAPER SHEETS GR 120	100	083384	22
774.00	KEYLESS CHUCK 10MM FEMALE THR.	1	774008	77	FC.07	FINISHING PAPER SHEETS GR 150	100	083391	22
774.50	KEYLESS CHUCK 13MM FEMALE THR.	1	774503	77	FC.08	FINISHING PAPER SHEETS GR 180	100	083407	22
775.00	KEYLESS CHUCK 10MM FEMALE THR.	1	775005	77	LQU/LTR	GRINDING FILES	10	37	
775.50	KEYLESS CHUCK 13MM FEMALE THR.	1	775500	77	MA/MN	GRINDING POINTS	10	32	
775.51	KEYLESS CHUCK 13MM-SDS+	1	775517	77	PG32A	ASSORTED BIT SET 32 PCS	1	071046	47
775.60	KEYLESS CHUCK 13MM FEMALE THR.	1	775609	77	RC.01	PAPER ROLL 120X50 YDS GR 40	1	085159	23
775.61	KEYLESS CHUCK 13MM-SDS+	1	775616	77	RC.03	PAPER ROLL 120X50 YDS GR 60	1	085166	23
780.00	CHUCK WITH KEY 10MM MALE THR	1	780009	78	RC.04	PAPER ROLL 120X50 YDS GR 80	1	085173	23
781.00	CHUCK WITH KEY 13MM MALE THR	1	781006	78	RC.05	PAPER ROLL 120X50 YDS GR 100	1	085180	23
783.00	CHUCK WITH KEY 10MM FEMALE THR	1	783000	78	RC.06	PAPER ROLL 120X50 YDS GR 120	1	085197	23
784.00	CHUCK WITH KEY 13MM FEMALE THR	1	784007	78	RC.07	PAPER ROLL 120X50 YDS GR 150	1	085203	23
786.00	CHUCK WITH KEY 10MM FEMALE THR	1	786001	78	RC.08	PAPER ROLL 120X50 YDS GR 180	1	085210	23
787.00	CHUCK WITH KEY 13MM FEMALE THR	1	787008	78	RC.09	PAPER ROLL 120X50 YDS GR 240	1	085227	23
787.01	CHUCK WITH KEY 13MM-SDS+	1	787015	78	RG/RG	FLAP SANDING WHEELS	10	29	
788.00	CHUCK WITH KEY 10 HEXAG. SHANK	1	788005	78	T.01	EMERY CLOTH SHEETS 23X28 GR 30	50	085869	23
788.50	CHUCK 0,5-6,5MM - HEX. SHANK	5	788500	78	T.03	EMERY CLOTH SHEETS 23X28 GR 40	50	085876	23
789.00	CHUCK ADAPTOR SDS+ 1/2X20	5	789002	79	T.04	EMERY CLOTH SHEETS 23X28 GR 60	50	085883	23
789.10	M6 LEFT HAND SCREW FOR CHUCKS	1	789101	79	T.05	EMERY CLOTH SHEETS 23X28 GR 80	50	085890	23
789.50	CHUCK ADAPTOR M3/8-M1/2	1	789507	79	T.06	EMERY CLOTH SHEETS 23X28 GR100	50	085906	23
789.60	CHUCK ADAPTOR M3/8-M3/8	1	789606	79	T.07	EMERY CLOTH SHEETS 23X28 GR150	50	085913	23
789.70	CHUCK ADAPTOR M1/2-F3/8	1	789705	79	T.08	EMERY CLOTH SHEETS 23X28 GR180	50	085920	23
790.00	DRILL CHUCK KEY 10MM B&D	10	790008	79	T.09	EMERY CLOTH SHEETS 23X28 GR240	50	085937	23
791.00	DRILL CHUCK KEY 13MM B&D	10	791005	79	T.10	EMERY CLOTH SHEETS 23X28 GR320	50	085944	23
792.00	UNIVERSAL DRILL CHUCK KEY 13MM	10	792002	79	T.11	EMERY CLOTH SHEETS 23X28 GR240	50	085951	23
793.00	UNIVERSAL DRILL CHUCK KEY 16MM	5	793009	79	T.12	EMERY CLOTH SHEETS 23X28 GR320	50	085968	23
794.00	UNIVERSAL DRILL CHUCK KEY	5	794006	79	T.13	EMERY CLOTH SHEETS 23X28 GR400	50	085975	23
800.00	HSS ENLARGING CUTTER 3/14MM	1	800004	11	WSC.001	WET+DRY PAPER SHEETS GR 100	100	085982	22
805.00	HSS ENLARGING CUTTER 6/20MM	1	805009	11	WSC.002	WET+DRY PAPER SHEETS GR 120	100	085999	22
810.00	HSS ENLARGING CUTTER 8/30MM	1	810003	11	WSC.003	WET+DRY PAPER SHEETS GR 150	100	086002	22
820.00	HSS ENLARGING CUTTER 20/40MM	1	820002	11	WSC.004	WET+DRY PAPER SHEETS GR 180	100	086019	22
825.00	HSS ENLARGING CUTTER 20/50MM	1	825007	11	WSC.005	WET+DRY PAPER SHEETS GR 220	100	086026	22
825.50	HSS STEP DRILL BIT 4/12MM	1	825502	11	WSC.006	WET+DRY PAPER SHEETS GR 240	100	086033	22
826.00	HSS STEP DRILL BIT 4/20MM	1	826004	11	WSC.007	WET+DRY PAPER SHEETS GR 280	100	086040	22
828.00	HSS STEP DRILL BIT 6/30MM	1	828008	11	WSC.008	WET+DRY PAPER SHEETS GR 320	100	086057	22
829.00	HSS STEP DRILL BIT 3,5/40MM	1	829005	11	WSC.009	WET+DRY PAPER SHEETS GR 360	100	086064	22

INDEX: REFERENCES, QUANTITIES AND BAR CODES

Place number 8011017 before EAN code

ref.	description	☐	ean	page	ref.	description	☐	ean	page
WSC.010	WET+DRY PAPER SHEETS GR 400	100	086071	22	WSC.012	WET+DRY PAPER SHEETS GR 600	100	086095	22
WSC.011	WET+DRY PAPER GR 500	100	086088	22					
M.1010	2 STEEL BALL CUTTERS 1,4	5	090009	94	M.4155	WHITE NYLON END WIRE BRUSH 5MM	5	090887	102
M.1020	2 STEEL BALL CUTTERS 2,3	5	090016	94	M.4160	WHITE NYLON CUP BRUSH 12MM	5	090894	102
M.1030	STEEL BALL CUTTER 4,0	5	090092	94	M.4165	WHITE NYLON WHEEL BRUSH 21MM	5	090900	102
M.1050	STEEL BALL CUTTER 6,0	5	090108	94	M.4170	3 ASSORTED WHITE NYLON BRUSHES	5	090917	102
M.1065	STEEL OVAL CUTTER 7,8	5	092928	94	M.4305	SILICON DISC POLISHER 12MM	5	090924	103
M.1070	2 STEEL CYLINDR. CUTTERS 1,4	5	090023	94	M.4310	SILICON LENTICULAR POLISHER 12	5	090931	103
M.1080	2 STEEL CYLINDR. CUTTERS 2,3	5	090030	94	M.4505	RUBBER POLISHING POINT 6MM	5	090948	103
M.1100	STEEL CYLINDRICAL CUTTER 6,0	5	090115	94	M.4510	RUBBER POLISHING POINT 5MM	5	090955	103
M.1105	STEEL CYLINDRICAL CUTTER 7,8	5	092935	94	M.4515	RUBBER POLISHING POINT 6MM	5	090962	103
M.1120	2 STEEL REV. TAPER CUTTERS 1,4	5	090047	94	M.4595	2 RUBBER POLISHING DISCS 22X3	5	090979	103
M.1130	2 STEEL REV. TAPER CUTTERS 2,3	5	090054	94	M.4605	FELT TAPER POLISHER 11MM	5	090986	104
M.1140	STEEL REVER.TAPER CUTTERS 4,0	5	090122	94	M.4610	FELT REV.TAPER POLISHER 14MM	5	090993	104
M.1170	2 STEEL FLAME CUTTERS 2,3	5	090061	94	M.4615	FELT WHEEL POLISHER 22MM	5	091006	104
M.1190	STEEL FLAME CUTTER 4,0	5	090139	94	M.4680	3 FELT POINTS + MANDREL +PASTE	5	091013	104
M.1240	STEEL CONE CUTTER 6,0	5	090146	94	M.4810	COTTON YARN DISC 24MM	5	091020	104
M.1270	2 STEEL COUNTERS. CUTTERS 2,3	5	090078	94	M.4820	SOFT FELT WHEEL 21MM	5	091037	104
M.1310	STEEL POINT CUTTER 6,0	5	090153	94	M.4830	CHAMOIS LEATHER DISC 21MM	5	091044	104
M.1340	2 STEEL WHEEL CUTTERS 2,3	5	090085	94	M.4840	COTTON FOLDS DISC 21MM	5	091051	104
M.1370	STEEL WHEEL CUTTER 6,0	5	090160	94	M.4850	ABRASIVE DISC SCOTCH FABRIC 22	5	091068	104
M.1375	STEEL WHEEL CUTTER 9,5	5	092942	94	M.4905	UNIVERSAL PRE-POLISHING PASTE	5	091075	104
M.1510	TUNGSTEN CARBIDE CUTTER 1,8MM	5	090177	95	M.4910	UNIVERSAL PASTE FINAL POLISH.	5	091082	104
M.1520	TUNGSTEN CARBIDE CUTTER 3MM	5	090184	95	M.4915	LAPPING PASTE	5	091099	104
M.1540	TUNGSTEN CARBIDE CUTTER 1,8MM	5	090191	95	M.5010	5 SLIM CUT OFF DISCS 22X0,25MM	5	091105	105
M.1550	TUNGSTEN CARBIDE CUTTER 3MM	5	090207	95	M.5030	10 CUT OFF DISCS 22X0,6MM	5	091112	105
M.1560	TUNGSTEN CARBIDE CUTTER 1,8MM	5	090214	95	M.5035	50 CUT OFF DISCS 22X0,6MM	5	091129	105
M.1570	TUNGSTEN CARBIDE CUTTER 3MM	5	090221	95	M.5040	10 REINFORCED CUT OFF DISCS 22	5	093680	105
M.1580	TUNGSTEN CARBIDE CUTTER 3MM	5	090238	95	M.5045	30 REINFORCED CUT OFF DISCS 22	5	093697	105
M.1710	HSS ROUNDING OFF CUTTER 3MM	2	090320	95	M.5050	5 REINFORCED CUT OFF DISCS 40	5	091136	105
M.1720	HSS COUING CUTTER 4MM	2	090337	95	M.5130	2 METAL ROUGHING DISCS 32X2,2	5	091143	105
M.1750	HSS FLUTE BIT GROOVES 3MM	2	090344	95	M.5405	MINI STEEL SAW BLADE 13MM	5	091150	106
M.1770	HSS ROUTER BIT V GROOVES 6,4MM	2	090351	95	M.5410	MINI STEEL SAW BLADE 19MM	5	091167	106
M.1905	DIAMOND BALL BIT 1,0MM	5	090245	96	M.5415	MINI STEEL SAW BLADE 25MM	5	091174	106
M.1910	DIAMOND BALL BIT 1,4MM	5	090252	96	M.5710	DIAMOND DISC 22MM	5	091181	106
M.1915	DIAMOND BALL BIT 1,8MM	5	090269	96	M.5715	DIAMOND DISC 30MM	5	093314	106
M.1925	DIAMOND CYLINDRICAL BIT 1,5MM	5	090276	96	M.5720	DIAMOND DISC 40MM	5	093321	106
M.1935	DIAMOND CYLINDRICAL BIT 3,2MM	5	090283	96	M.5750	SEGMENTED DIAMOND DISC 22MM	5	093338	106
M.1950	DIAMOND FLAME BIT 1,6MM	5	090290	96	M.5905	SPIRAL WOOD CUTTING BIT 3,2MM	5	093345	106
M.1970	DIAMOND POINT BIT 2,8MM	5	090306	96	M.5910	SPIRAL DRYWALL CUTTING BIT 3,2	5	093352	106
M.1980	DIAMOND DISC BIT 5,0MM	5	090313	96	M.5915	SPIRAL TILE CUTTING BIT 3,2MM	5	093369	106
M.2010	2 RUBY GRINDING STONES 3X8MM	5	090368	97	M.6005	2 HSS DRILL BITS 0,5MM	5	091198	107
M.2025	2 RUBY GRINDING STONES 5X10MM	5	090375	97	M.6006	2 HSS DRILL BITS 0,6MM	5	091204	107
M.2040	2 RUBY GRINDING STONES 8X10MM	5	090382	97	M.6008	2 HSS DRILL BITS 0,8MM	5	091211	107
M.2055	2 RUBY GRINDING STONES 10X12MM	5	090399	97	M.6010	2 HSS DRILL BITS 1,0MM	5	091228	107
M.2070	2 RUBY GRINDING STONES 12X15MM	5	090405	97	M.6012	2 HSS DRILL BITS 1,2MM	5	091235	107
M.2085	2 RUBY GRINDING STONES 3X8MM	5	090412	97	M.6015	2 HSS DRILL BITS 1,5MM	5	091242	107
M.2100	2 RUBY GRINDING STONES 5X10MM	5	090429	97	M.6020	2 HSS DRILL BITS 2,0MM	5	091259	107
M.2115	2 RUBY GRINDING STONES 8X12MM	5	090436	97	M.6024	2 HSS DRILL BITS 2,4MM	5	091266	107
M.2130	2 RUBY GRINDING STONES 6X10MM	5	090443	97	M.6030	2 HSS DRILL BITS 3,0MM	5	091273	107
M.2145	2 RUBY GRINDING STONES 10X20MM	5	090450	97	M.6100	20 HSS DRILL BITS 0,3/1,6MM	2	091396	107
M.2160	2 RUBY GRINDING STONES 6MM	5	090467	97	M.6206	REINF. HSS DRILL BIT 0,6MM	5	091280	107
M.2175	2 RUBY GRINDING STONES 10MM	5	090474	97	M.6208	REINF. HSS DRILL BIT 0,8MM	5	091297	107
M.2190	2 RUBY GRINDING STONES 6X12MM	5	090481	97	M.6210	REINF. HSS DRILL BIT 1,0MM	5	091303	107
M.2205	2 RUBY GRINDING STONES 8X15MM	5	090498	97	M.6212	REINF. HSS DRILL BIT 1,2MM	5	091310	107
M.2220	2 RUBY GRINDING STONES 10X20MM	5	090504	97	M.6215	REINF. HSS DRILL BIT 1,5MM	5	091327	107
M.2235	2 RUBY GRINDING STONES 8X6MM	5	090511	97	M.6220	REINF. HSS DRILL BIT 2,0MM	5	091334	107
M.2410	2 SILICON CARBIDE STONES 3X8MM	5	090528	98	M.8010	5 COLLETS + COLLET NUT	2	093017	108
M.2420	2 SILICON CARBIDE STONES 5X10	5	090535	98	M.8020	4 COLLETS + COLLET NUT DREMEL	2	093024	108
M.2435	2 SILICON CARBIDE STONES 4MM	5	090542	98	M.8100	MANDREL	5	091358	108
M.2450	2 SILICON CARBIDE STONES 8X6MM	5	090559	98	M.8110	REINFORCED MANDREL	5	091365	108
M.2465	2 SILICON CARBIDE STONES 6X10	5	090566	98	M.8120	PYRAMIDAL MANDREL	5	091372	108
M.2480	2 SILICON CARBIDE STONES 5X10	5	090573	98	M.8210	KIT 10 ENGRAVING ACCESSORIES	2	093031	109
M.2510	2 RUBY GRINDING STONES 22MM	5	090580	98	M.8230	KIT 10 GRINDING ACCESSORIES	2	093048	109
M.2520	2 SILICON CARBIDE STONES 22MM	5	090597	98	M.8250	KIT 9 CLEANING ACCESSORIES	2	093055	109
M.2610	2 RUBY GRINDING STONES 22MM	5	090603	98	M.8270	KIT 58 CUTTING ACCESSORIES	2	093062	109
M.2620	2 SILICON CARBIDE STONES 22MM	5	090610	98	M.8305	5M EXTENSION CABLE	1	091402	108
M.2630	2 WHITE GRINDING STONES 22MM	5	090627	98	M.8500	MINI FLEXIBLE SHAFT 80CM	1	091426	110
M.2640	2 BROWN GRINDING STONES 22MM	5	090634	98	M.8550	KEYLESS CHUCK 0,4/3,2MM	1	091389	110
M.2710	2 CHAIN SHARP. WHEELS 4,0X19MM	5	090641	99	M.8560	KEYLESS CHUCK 0,4/3,2MM DREMEL	1	093376	110
M.2715	2 CHAIN SHARP. WHEELS 4,8X19MM	5	090658	99	M.8580	CHUCK WITH KEY 0,5/6MM	1	093598	110
M.2720	2 CHAIN SHARP. WHEELS 5,6X21MM	5	090665	99	M.8600	ROTARY DRILL HOLDER 43+33MM	1	091433	111
M.2910	DRESSING STONE DOUBLE GRAIN	5	090672	99	M.8710	MINI DRILL STAND	1	093666	111
M.3020	FLAP SANDING WHEEL 20X05MM 80	5	090689	100	M.8750	MINI VICE 50MM	1	093383	111
M.3030	FLAP SANDING WHEEL 30X10MM 80	5	090696	100	M.8775	PRECISION SCREWDRIVER SET 45	1	093574	111
M.3210	BACKING PAD + 6 SANDING DISCS	5	090702	100	M.8790	PRECISION CUTTERS KIT 18 PCS	1	093581	112
M.3220	10 ADHESIVE DISCS 20MM GR.100	5	090719	100	M.8800	WOODBURNING PEN 30W + 2 TIPS	1	093550	112
M.3230	10 ADHESIVE DISCS 20MM GR.220	5	090726	100	M.8815	GLUE GUN 30W - 7MM	1	093703	113
M.3610	DRUM SANDER 13X13MM	5	090733	100	M.8820	GLUE GUN 20W - 7MM	1	093529	113
M.3620	12 SANDING BELTS 13MM GR. 60	5	090740	100	M.8822	12 GLUE STICKS 7X100MM	10	600000	113
M.3630	12 SANDING BELTS 13MM GR.120	5	090757	100	M.8845	GLUE GUN 60W - 11MM	1	093710	113
M.3640	DRUM SANDER 9,5X13MM	5	092959	101	M.8857	12 GLUE STICKS 11X100MM	10	600208	113
M.3650	12 SANDING BELTS 9,5MM GR. 60	5	092966	101	M.9000	ONE SPEED TRANSFORMER	1	091440	114
M.3660	12 SANDING BELTS 9,5MM GR.120	5	092973	101	M.9100	HIGH TORQUE ROTARY TOOL 30W	1	091464	116
M.3670	DRUM SANDER 6,3X13MM	5	092980	101	M.9150	MINI ROTARY TOOL KIT 30W	1	091471	116
M.3680	12 SANDING BELTS 6,3MM GR. 60	5	092997	101	M.9200	ENGRAVING PEN 6W	1	091488	114
M.3690	12 SANDING BELTS 6,3MM GR.120	5	093000	101	M.9220	ENGRAVING PEN 6W + TRANSFORMER	1	093628	115
M.4005	STEEL END WIRE BRUSH 5MM	5	090764	102	M.9250	ENGRAVING TOOL KIT 6W	1	091495	115
M.4010	STEEL CUP BRUSH 12MM	5	090771	102	M.9300	PRECISION ROTARY TOOL 60W	1	093604	117
M.4015	STEEL WHEEL BRUSH 21MM	5	090788	102	M.9350	MINI ROTARY TOOL KIT 60W	1	093611	117
M.4020	3 ASSORTED STEEL BRUSHES	5	090795	102	M.9500	HIGH TORQUE ROTARY TOOL 130W	1	093116	118
M.4055	BRASS END WIRE BRUSH 5MM	5	090801	102	M.9550	MINI ROTARY TOOL KIT 130W	1	093123	118
M.4060	BRASS CUP BRUSH 12MM	5	090818	102	M.9600	HIGH TORQUE ROTARY TOOL 170W	1	093413	119
M.4065	BRASS WHEEL BRUSH 21MM	5	090825	102	M.9650	MINI ROTARY TOOL KIT 170W LCD	1	093420	119
M.4070	3 ASSORTED BRASS BRUSHES	5	090832	102	M.BOX01	MODULAR STORAGE CASE	1	082828	110
M.4105	BLACK BRISTLE END WIRE BRUSH 5	5	090849	102	ESPO.M3A	PG MINI DISPLAYER 162 PCS	1	093727	120
M.4110	BLACK BRISTLE CUP BRUSH 12MM	5	090856	102	ESPO.M3B	PG MINI DISPLAYER 141 PCS	1	093734	120
M.4115	BLACK BRISTLE WHEEL BRUSH 21MM	5	090863	102	ESPO.M3C	PG MINI DISPLAYER 709 PCS	1	093741	121
M.4120	3 ASSORTED BLACK BRISTLE BRUSH	5	090870	102					

GENERAL CONDITIONS OF SALE

P.G. SRL DECLINES ALL RESPONSIBILITY FOR DAMAGES CAUSED BY ITS OWN PRODUCTS IMPUTABLE TO AN ERRONEOUS AND/OR INCAUTIOUS AND/OR IMPROPER USE OF THE SAME

Orders are accepted only at the following conditions:

- The transport is effected by the mean of conveyance considered more suitable by P.G. Srl
- Delivery leads are never binding and could be not respected, therefore compensations for delays and/or partial deliveries and/or non-deliveries are excluded
- Any complaint for objections or discrepancies found out on the materials delivered shall reach us within eight days from the receiving of the goods
- Payments shall be made according to the agreed conditions
- No price reduction or rounding off is accepted, unless previously agreed
- In case of late payment default interest and incidental charges shall run from due date
- Any dispute shall be settled by the Court of Bologna as the only Court of competent jurisdiction, though the contract has been entered in a different place

ANY USE AND/OR REPRODUCTION ALSO PARTIAL OF THE TEXT, OF DRAWINGS AND PICTURES IS FORBIDDEN IF NOT AUTHORIZED BY P.G. SRL

PICTURES, DESCRIPTIONS, DRAWINGS AND BOARDS ARE ONLY INDICATIVES AND NOT BINDING, P.G. SRL MAY CHANGE THE PRODUCTS WITHOUT ANY NOTICE



P.G. Srl
Via Piretti, 12/A
40012 Calderara di Reno (BO) Italia
Tel. +39.051.727.102 - Fax +39.051.728.075
info@pgprofessional.it - www.pgprofessional.it
info@pgmini.it - www.pgmini.it