

2019
CATALOGO



mini



Professional

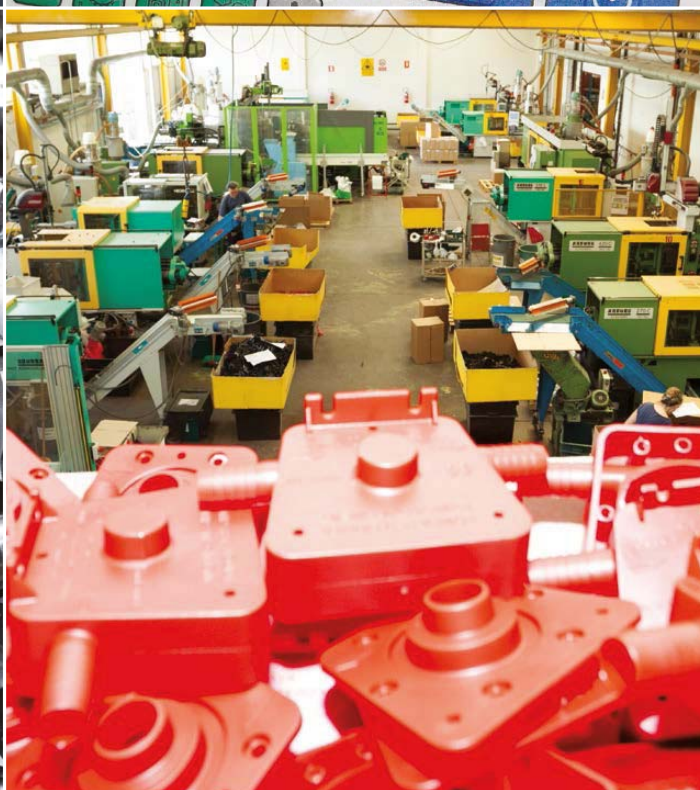
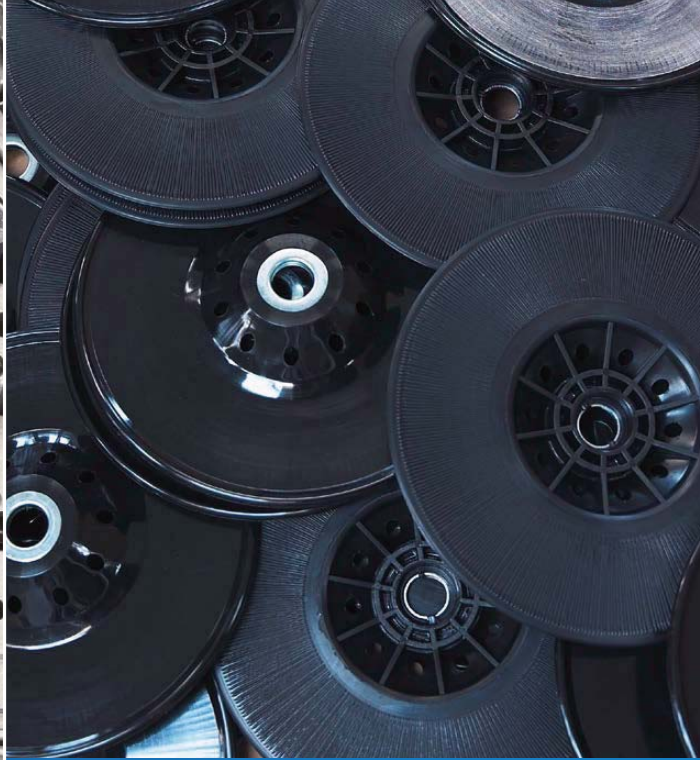

COMPETENZA, QUALITÀ E SPECIALIZZAZIONE. LA FORZA DI PG.

Produzione, qualità, gamma e specializzazione: su questi punti di forza PG ha fondato la propria struttura produttiva ed organizzativa.

L'affidabilità del marchio PG si sviluppa e si rafforza nel tempo: nata negli anni '50 come officina meccanica di precisione specializzata nella produzione di minuterie metalliche, all'inizio degli anni '80 pur proseguendo nella sua originaria attività, inizia la produzione e la vendita con il marchio PG di altri prodotti, ampliando e diversificando sempre più la gamma degli utensili ed accessori per trapano.

Una lunga esperienza e una realtà innovativa e dinamica in grado di garantire sempre risposte precise e specifiche, hanno consentito a PG di svolgere al proprio interno l'intero ciclo di produzione e controllo del prodotto cercando di ridurre il più possibile l'impatto ambientale durante il ciclo di fabbricazione, in un ambiente di lavoro sicuro, responsabile e collaborativo.

Identificazione e sviluppo dei nuovi progetti, selezione e qualifica delle materie prime, controlli in linea e sui prodotti finiti, ottimizzazione dei tempi operativi, adozione di metodi di gestione razionali e sicuri, scrupolosi test di approvazione e controlli rigorosi secondo gli attuali standard di sicurezza europei, sino ad arrivare ad un accurato studio del packaging per l'ottenimento di una esposizione ottimale nel punto vendita.

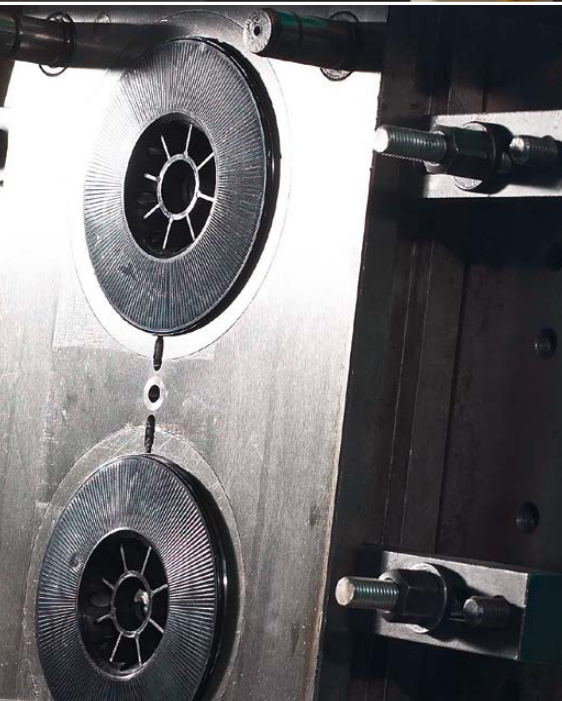
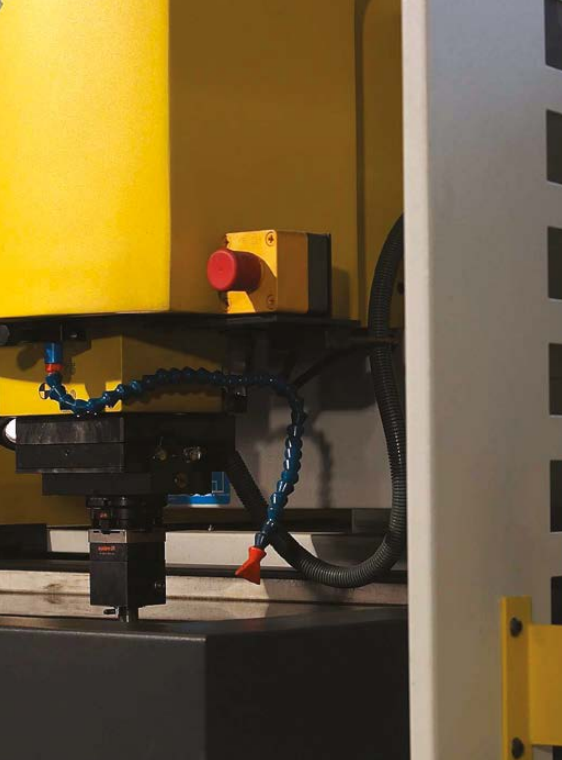
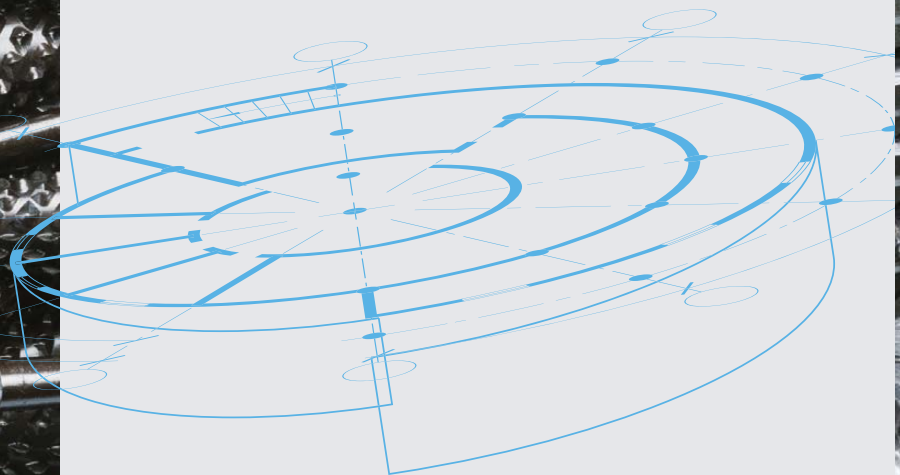
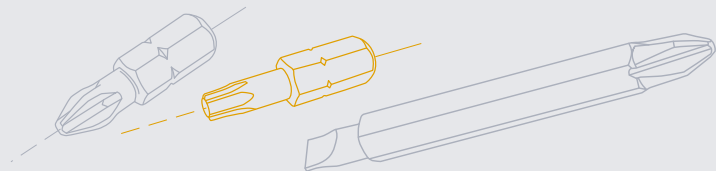



PG ha sviluppato e potenziato una rete di distribuzione capillare, efficiente e flessibile presente sui più importanti mercati che consente di offrire alla clientela una costante disponibilità al dialogo, un servizio di alto livello ed un elevato rapporto qualità-prezzo.

La gamma PG sempre in costante evoluzione è in grado di fornire un assortimento completo e compatibile con le più importanti marche di elettrotensili. Sono queste le caratteristiche e i vantaggi che fanno di PG una garanzia ed un punto di riferimento per chi desidera il meglio della produzione nel mercato del fai da te, ferramenta ed utensileria.

L'esperienza maturata da PG, lavorando quotidianamente al fianco dei propri clienti, le ha permesso di sviluppare un'approfondita conoscenza delle esigenze espositive e logistiche del punto vendita.

Lo studio attento del packaging, dei suoi colori e l'armonizzazione dei suoi formati, si è unito alla ricerca di soluzioni modulari e flessibili per l'esposizione. PG è così in grado di offrire un sistema di esposizione particolarmente efficace, che permette di presentare l'intera gamma di prodotti con un notevole impatto visivo per la clientela.

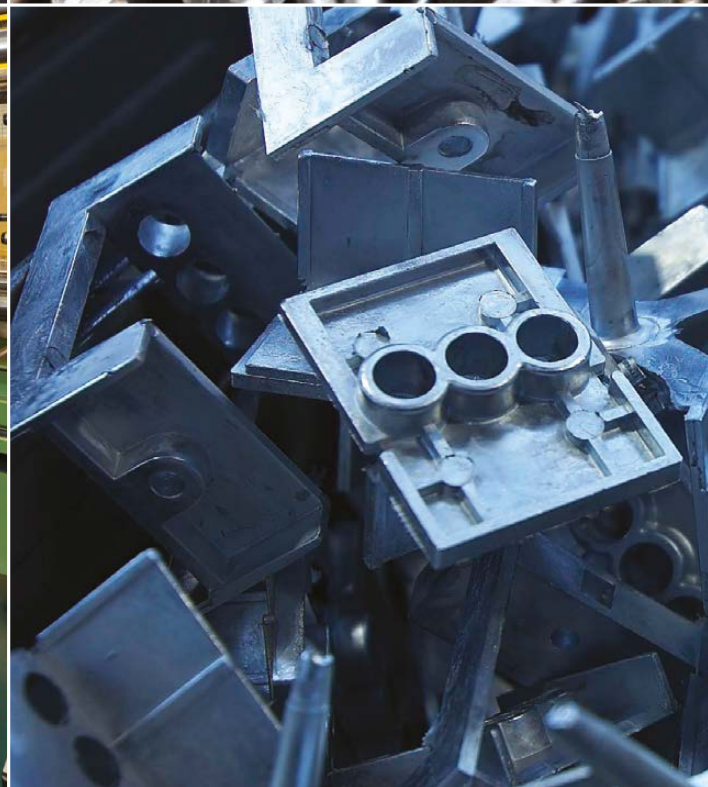
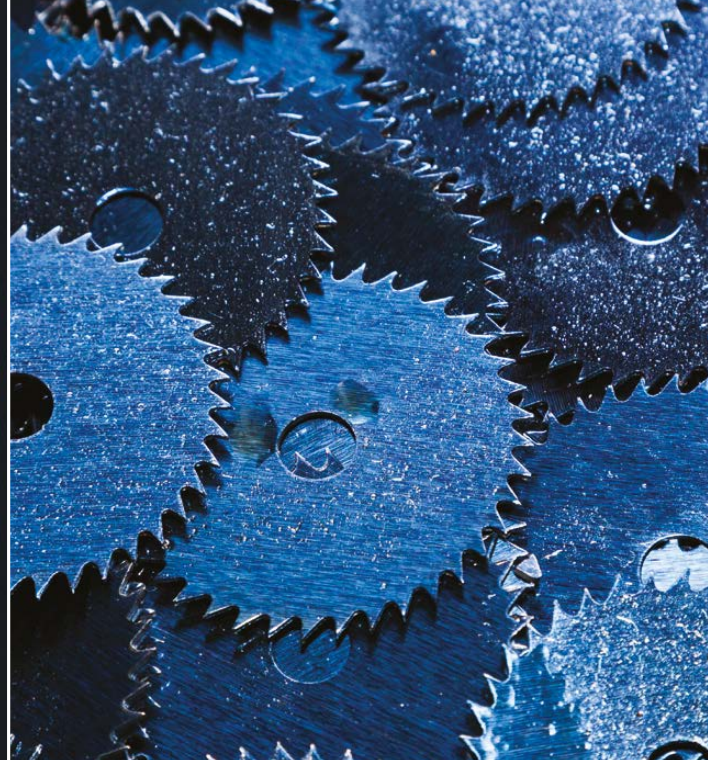
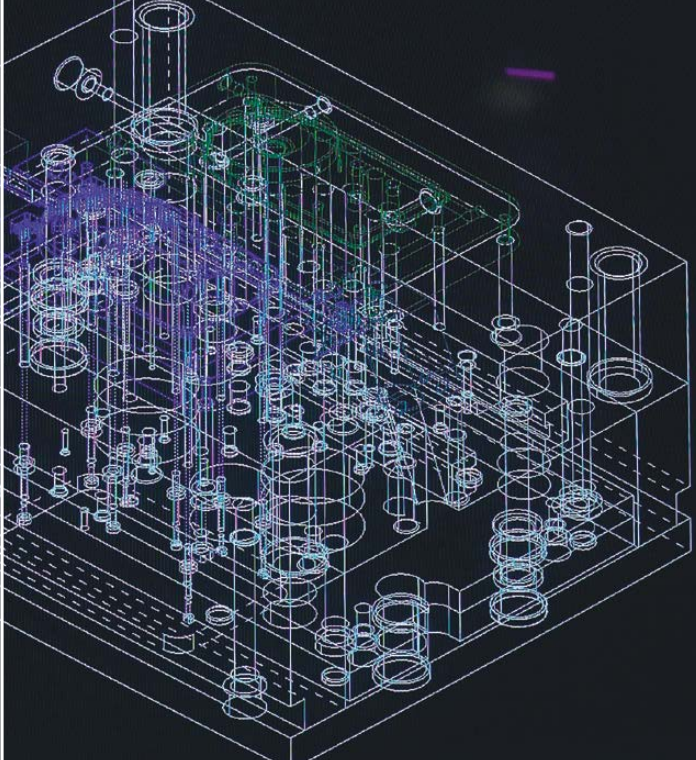



I TUOI COLLABORATORI PROFESSIONALI

Una gamma completa e specializzata di accessori e utensili per il fai da te compatibile con tutte le principali marche di elettroutensili e capace di rispondere con sicurezza e affidabilità a tutte le esigenze nel mercato del bricolage, ferramenta ed utensileria.

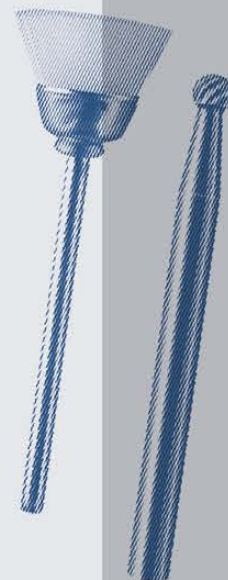

PICCOLI RESISTENTI E PRECISI

Una vasta linea di mini utensili ed accessori per modellismo, hobby, elettronica e artigianato, che unisce la massima precisione e resistenza alla forza dell'universalità, con un packaging moderno ed accattivante dal forte impatto visivo.



8
IDRAULICA



11
UTENSILI HSS



13
ACCESSORI UNIVERSALI



43
LIME E RASPE



45
INSERTI



48
SPAZZOLE



58
ANTI INFORTUNISTICA



69
SPINATURA



71
LAME PER SEGHETTI ALTERNATIVI



74
SEGHE A TAZZA



76
LAME PER SEGHE CIRCOLARI

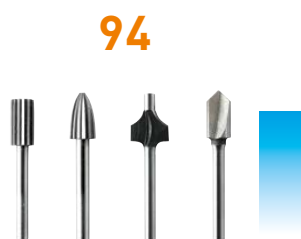

94
INTAGLIO
INCISIONE FRESATURA



97
SMERIGLIATURA
AFFILATURA



100
LEVIGATURA



108
ACCESSORI VARI



114
TRAPANI
TRASFORMATORI KIT

15



LUCIDATURA

18



LEVIGATURA
SMERIGLIATURA

30



TRONCATURA
SMERIGLIATURA

39



FRESE

41



MECCHIE E
PUNTE FORSTNER

62



MISCELATORI

63



CUTTER

65



UTENSILI PER LEGNO

67



GRAFFATRICI

68



FLESSOMETRI

77



MANDRINI

80



UTENSILI E
ACCESSORI VARI

82



SERRAGGIO

85



SUPPORTI

87



PUNTE

102



PULITURA LUCIDATURA

105



TAGLIO SGROSSATURA

107



PUNTE HSS PER FORATURA

FRESA PER RETTIFICARE LE SEDI DEI RUBINETTI

Filettatura esterna

103	con boccia conica \varnothing 28 x 25 mm fresa a 24 tagli 1/2	10	103006
212	con boccia conica \varnothing 28 x 25 mm 2 frese a 24 tagli 3/8 - 1/2 e 2 guarnizioni	10	212005
201	con boccia conica \varnothing 40 x 27 mm 4 frese a 24 tagli 3/8 - 1/2 - 3/4 - 1" 2 bocchie coniche \varnothing 27 - 32 mm	1	201009
203	con boccia conica \varnothing 32 x 27 mm 2 frese a 24 tagli 1/2 - 3/4 e 2 guarnizioni	1	203003
205	con boccia conica \varnothing 40 x 27 mm 4 frese a 24 tagli 3/8 - 1/2 - 3/4 - 1"	1	205007
204	con boccia conica \varnothing 65 x 65 mm 4 frese a 24 tagli 1" 1/8 - 1" 1/4 - 1" 1/2 - 2"	1	204147
207	con boccia conica \varnothing 40 x 27 mm 4 frese a 24 tagli 3/8 - 1/2 - 3/4 - 1"	1	207001
208	con doppio cono \varnothing 30 x 60 mm 6 frese a 24 tagli \varnothing 10 - 12 - 13 - 14 - 15 - 16 mm	1	208008
209	con doppio cono \varnothing 25 x 46 mm 3 frese a 24 tagli \varnothing 13 - 15 - 16 mm	1	209005

FRESA PER RETTIFICARE LE SEDI DEI RUBINETTI

Filettatura esterna - interna

202	con boccia conica \varnothing 42 x 42 mm 4 frese a 24 tagli 3/8 - 1/2 - 3/4 - 1"	1	202006
------------	---	---	--------

FRESA PER RETTIFICARE LE SEDI DEI RUBINETTI

Filettatura esterna - cilindrica

210	con boccola cilindrica \varnothing 33 x 38 mm 4 frese a 24 tagli 3/8 - 1/2 - 3/4 - 1"	1	210001
213	con boccola cilindrica \varnothing 28 x 24 mm 2 frese a 24 tagli 3/8 - 1/2 e 2 guarnizioni	10	213002

**FRESA A 24 TAGLI**

11.010	\varnothing 10 mm	10	110103
11.012	\varnothing 12 mm	10	110127
11.014	\varnothing 14 mm - 3/8	10	110141
11.017	\varnothing 17 mm - 1/2	10	110172
11.024	\varnothing 24 mm - 3/4	10	110240
11.028	\varnothing 28 mm - 1"	10	110288
11.034	\varnothing 34 mm - 1" 1/8	5	110349
11.038	\varnothing 38 mm - 1" 1/4	5	110387
11.043	\varnothing 43 mm - 1" 1/2	5	110431
11.055	\varnothing 55 mm - 2"	5	110554

**MORSETTO ALLARGATUBI** completo di punzone

300.00	per tubi \varnothing 10 - 12 - 14 - 16 mm	1	300009
304.00	per tubi \varnothing 10 - 12 - 14 - 16 - 18 - 20 - 22 mm	1	304007



CHIAVE PER LAVABO

305.00	uso destro e sinistro	5	305004
---------------	-----------------------	---	--------

TAGLIATUBO

Per tubi di rame, ottone, plastica e ferro



316.00	da 1/8 a 5/8 - 16 mm	5	316000
---------------	----------------------	---	--------

328.00	da 1/8 a 1" 1/8 - 28 mm	5	328003
---------------	-------------------------	---	--------

332.00	da 1/8 a 1" 1/4 - 32 mm	5	332000
---------------	-------------------------	---	--------

TAGLIATUBO TELESCOPICO

Per tubi di rame, ottone, plastica e ferro



332.35	da 1/8 a 1" 3/8 - 35 mm	5	332352
---------------	-------------------------	---	--------

334.00	da 1/4 a 1" 5/8 - 42 mm con 2 rotelle e svasatore estraibile	1	334004
---------------	---	---	--------

ROTELLA DI RICAMBIO

333.00	universale	10	333007
---------------	------------	----	--------

334.20	per art. 334.00	10	334202
---------------	-----------------	----	--------

UTENSILE CONICO PERFORATORE IN HSS per acciaio

800.00	da \varnothing 3 mm a \varnothing 14 mm - gambo \varnothing 6 mm - 550 RPM	1	800004
805.00	da \varnothing 6 mm a \varnothing 20 mm - gambo \varnothing 8 mm - 500 RPM	1	805009
810.00	da \varnothing 8 mm a \varnothing 30 mm - gambo \varnothing 10 mm - 400 RPM	1	810003
820.00	da \varnothing 20 mm a \varnothing 40 mm - gambo \varnothing 10 mm - 300 RPM	1	820002
825.00	da \varnothing 20 mm a \varnothing 50 mm - gambo \varnothing 10 mm - 200 RPM	1	825007

**FRESA A GRADINI IN HSS per acciaio**

825.50	da \varnothing 4 mm a \varnothing 12 mm - gambo \varnothing 6 mm - 800 RPM	1	825502
826.00	da \varnothing 4 mm a \varnothing 20 mm - gambo \varnothing 8 mm - 500 RPM	1	826004
828.00	da \varnothing 4 mm a \varnothing 30 mm - gambo \varnothing 10 mm - 400 RPM	1	828008
829.00	da \varnothing 3,5 mm a \varnothing 40 mm - gambo \varnothing 10 mm - 300 RPM	1	829005



FRESA CONICA IN HSS per acciaio

835.00	da \varnothing 0 mm a \varnothing 25 mm - gambo \varnothing 8 mm - 500 RPM	5	835006
835.50	da \varnothing 6 mm a \varnothing 32 mm - gambo \varnothing 10 mm - 500 RPM	1	835501
835.60	da \varnothing 6 mm a \varnothing 45 mm - gambo \varnothing 10 mm - 300 RPM	1	835600

SVASATORE IN HSS per acciaio - gambo \varnothing 8 mm

840.00	\varnothing 12 mm - 500 RPM	5	840000
845.00	\varnothing 16 mm - 500 RPM	5	845005
850.00	\varnothing 20 mm - 500 RPM	5	850009

FORALASTRA per tagliare laminati e metalli

214.00	attacco cilindrico \varnothing 8 mm - guida fissa centrante \varnothing 6 mm per forare da 20 mm a 123 mm - completo di punta HSS \varnothing 6 mm e chiave di servizio - utensile \square 5 mm in acciaio HSS al 5% di cobalto - 250 RPM	5	214009
215.00	attacco cilindrico \varnothing 12 mm - guida fissa centrante \varnothing 10 mm per forare da 25 mm a 217 mm - completo di punta HSS \varnothing 10 mm e chiave di servizio - utensile \square 6 mm in acciaio HSS al 5% di cobalto - 250 RPM	5	215006
216.00	attacco cilindrico \varnothing 8 mm - con punta HSS \varnothing 4 mm centrante per forare da 27 mm a 104 mm - utensile \square 5 mm in acciaio HSS al 5% di cobalto - 250 RPM	5	216003

UTENSILE DI RICAMBIO IN HSS al 5% di cobalto

214.10	\square 5 mm per art. 214.00	5	214108
215.10	\square 6 mm per art. 215.00	5	215105
216.10	\varnothing 5 mm per art. 216.00	5	216102

GHIERA CONICA per platorelli - collare ø **22** mm

218.00	14 MA	<input checked="" type="checkbox"/>	218007
220.00	8 MA	<input type="checkbox"/>	220000
220.50	10 MA - collare ø 16 mm	<input type="checkbox"/>	220505
221.00	10 MA	<input type="checkbox"/>	221007
222.00	14 MA	<input type="checkbox"/>	222004
223.00	5/8"	<input type="checkbox"/>	223001

**GHIERA PIANA** per mole a disco - collare ø **22** mm

219.00	14 MA	<input checked="" type="checkbox"/>	219004
224.00	8 MA	<input type="checkbox"/>	224008
225.00	10 MA	<input type="checkbox"/>	225005
226.00	14 MA	<input type="checkbox"/>	226002
227.00	5/8"	<input type="checkbox"/>	227009

**CHIAVE DI SERVIZIO** per ghiera

228.00	35 mm	<input checked="" type="checkbox"/>	228006
229.00	35 mm	<input type="checkbox"/>	229003
230.00	20/35 mm - regolabile	<input checked="" type="checkbox"/>	230009
231.00	20/35 mm - regolabile	<input type="checkbox"/>	231006

**FLANGIA POGGIA DISCO POSTERIORE**

250.00	per dischi ø 115 mm ø 41 mm - spessore 7,5 mm - foro ø 14 mm	<input type="checkbox"/>	250007
253.00	per dischi ø 230 mm ø 41 mm - spessore 9 mm - foro ø 14 mm	<input type="checkbox"/>	253008

**PERNO DI FISSAGGIO**

335.00	10,0 x 6 mm	<input checked="" type="checkbox"/>	335001
336.00	12,8 x 8 mm	<input type="checkbox"/>	336008
337.00	22,2 x 8 mm	<input type="checkbox"/>	337005



PLATORELLO DI GOMMA

338.00	Ø 125 mm - gambo Ø 6 mm	10	338002
338.05	Ø 180 mm - foro Ø 16 mm	10	338057
338.08	Ø 180 mm - foro Ø 16 mm	10	338088

PLATORELLO DI NYLON

338.10	Ø 100 mm - foro Ø 10 mm	10	338101
338.20	Ø 115 mm - foro Ø 14 mm	10	338200
338.22	Ø 178 mm - foro Ø 14 mm	10	338224
338.25	Ø 100 mm - foro Ø 10 mm	10	338255
338.30	Ø 115 mm - foro Ø 10 mm	10	338309
338.35	Ø 115 mm - foro Ø 14 mm	10	338354
338.40	Ø 115 mm - foro Ø 16 mm	10	338408
338.45	Ø 125 mm - foro Ø 14 mm	10	338453
338.50	Ø 125 mm - foro Ø 16 mm	10	338507
338.55	Ø 150 mm - foro Ø 14 mm	10	338552
338.60	Ø 150 mm - foro Ø 16 mm	10	338606
338.65	Ø 178 mm - foro Ø 14 mm	10	338651
338.70	Ø 178 mm - foro Ø 16 mm	10	338705
338.75	Ø 178 mm - foro Ø 14 mm - colore bianco	10	338750

PLATORELLO CON VELCRO BIADESIVO

perno Ø 10 mm - foro M14

338.80	Ø 115 mm	5	338804
338.82	Ø 125 mm	5	338828
338.85	Ø 150 mm	5	338859

CUFFIA CON LACCIO DI CHIUSURA

339.00	ø 140 mm	10	339009
339.20	ø 190 mm	10	339207

CUFFIA IN LANA D'AGNELLO CON FISSAGGIO VELCRO

339.22	ø 115 mm	10	339221
339.23	ø 125 mm	10	339238
339.24	ø 160 mm	10	339245

DISCO IN FELTRO

339.25	ø 80 x 10 mm - foro ø 13 mm	10	339252
339.27	ø 125 x 15 mm - foro ø 16 mm	10	339276
339.28	ø 150 x 20 mm - foro ø 16 mm	10	339283

DISCO IN FELTRO CON FISSAGGIO VELCRO

339.26	ø 125 mm	10	339269
---------------	----------	----	--------

PANNO IN FELTRO CON FISSAGGIO VELCRO per levigatrici a Delta

339.29	93 mm	10	339290
---------------	-------	----	--------

RUOTA IN TESSUTO

339.30	ø 80 mm - gambo ø 6 mm	10	339306
339.35	ø 100 mm - foro ø 20/13 mm	10	339351
339.40	ø 120 mm - foro ø 20/16 mm	10	339405
339.45	ø 150 mm - foro ø 20/16 mm	10	339450



**RUOTA IN SISAL E COTONE per pre-lucidatura**

339.46	Ø 80 mm - gambo Ø 6 mm	10	339467
---------------	------------------------	----	--------

339.49	Ø 150 mm - foro Ø 20/16 mm	10	339498
---------------	----------------------------	----	--------

**TAMPONE IN SPUGNA**

339.50	Ø 125 mm - gambo Ø 6 mm	1	339504
---------------	-------------------------	---	--------

339.60	Ø 175 mm - foro M14	1	339603
---------------	---------------------	---	--------

**TAMPONE DI RICAMBIO**

339.62	Ø 125 mm	1	339627
---------------	----------	---	--------

339.64	Ø 175 mm	1	339641
---------------	----------	---	--------

**TAMPONE CON FISSAGGIO VELCRO**

339.66	Ø 115 mm	1	339665
---------------	----------	---	--------

339.67	Ø 125 mm	1	339672
---------------	----------	---	--------

339.68	Ø 160 mm	1	339689
---------------	----------	---	--------

**PASTA PER LUCIDARE**

359.36	2 stick pasta marrone per pre-lucidatura	10	359366
---------------	--	----	--------

359.37	2 stick pasta blu per lucidatura finale	10	359373
---------------	---	----	--------

359.38	2 stick pasta assortiti	10	359380
---------------	-------------------------	----	--------

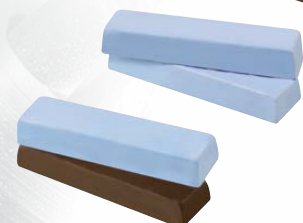

RUOTA A LAMELLE IN PANNO ABRASIVOAggressività leggera - grana **150**

359.40	ø 50 x 25 mm - gambo ø 6 mm	5	359403
359.42	ø 75 x 45 mm - gambo ø 6 mm	5	359427
359.44	ø 100 x 50 mm - gambo ø 6 mm	5	359441
359.70	ø 150 x 25 mm - foro ø 32/20 mm	5	359700

**RUOTA A LAMELLE IN PANNO E TELA ABRASIVA**Aggressività media - grana **150**

359.46	ø 50 x 25 mm - gambo ø 6 mm	5	359465
359.48	ø 75 x 45 mm - gambo ø 6 mm	5	359489
359.50	ø 100 x 50 mm - gambo ø 6 mm	5	359502
359.72	ø 150 x 25 mm - foro ø 32/20 mm	5	359724

**DISCO IN FIBRE DI NYLON**

359.82	piano ø 100 mm - foro ø 13 mm	5	359823
359.86	a centro depresso ø 115 mm - foro ø 22 mm	5	359861



imballo PG



imballo neutro

TAMPONE DI GOMMA

339.70	125 x 70 mm - con fissaggio manuale	10	339702
339.72	125 x 70 mm - con fissaggio velcro e manuale	5	339726
339.73	con fissaggio velcro per dischi ø 125 mm - per superfici concave	5	339733
339.74	con fissaggio velcro per dischi ø 125 mm	5	339740
339.75	con fissaggio velcro per dischi ø 125 mm	5	339757
339.76	con fissaggio velcro per dischi ø 150 mm	5	339764
339.79	MINI - con fissaggio velcro per fogli - per rifinitura	5	339795

FOGLI ABRASIVI VELCRO per MINI tampone di gomma

348.25	10 fogli grana grossa per art. 339.79	5	348254
348.26	10 fogli grana media per art. 339.79	5	348261
348.27	10 fogli grana fine per art. 339.79	5	348278

SPUGNA ABRASIVA

339.80	1 spugna abrasiva - doppia grana 60/100 - per legno e metallo	10	339801
339.81	250 spugne abrasive - doppia grana 60/100 - per legno e metallo	1	339818
339.85	24 spugne abrasive - doppia grana 60/100 - per legno e metallo - in espositore self-service	1	339856
339.90	2 spugne abrasive - grana 100 - per metallo e carrozzeria	10	339900
339.91	250 spugne abrasive - grana 100 - per metallo e carrozzeria	1	339917

DISCHI DI CARTA ABRASIVA - ø 125 mm - supporto 160 g

340.00	15 dischi grana 50	<input checked="" type="checkbox"/>	340005
341.00	15 dischi grana 80	<input checked="" type="checkbox"/>	341002
342.00	15 dischi grana 120	<input checked="" type="checkbox"/>	342009
343.00	15 dischi grane assortite	<input checked="" type="checkbox"/>	343006

DISCHI DI CARTA ABRASIVA - ø 125 mm - supporto 230 g

344.00	5 dischi grana 50	<input checked="" type="checkbox"/>	344003
344.10	5 dischi grana 80	<input checked="" type="checkbox"/>	344102
344.20	5 dischi grana 120	<input checked="" type="checkbox"/>	344201
344.30	5 dischi grane assortite	<input checked="" type="checkbox"/>	344300

DISCHI DI TELA ABRASIVA - ø 125 mm

350.00	6 dischi grana 40	<input checked="" type="checkbox"/>	350004
351.00	6 dischi grana 80	<input checked="" type="checkbox"/>	351001
352.00	6 dischi grana 150	<input checked="" type="checkbox"/>	352008
353.00	6 dischi grane assortite	<input checked="" type="checkbox"/>	353005

DISCHI DI CARTA E TELA ABRASIVA - ø 125 mm

355.00	4 dischi tela + 8 dischi carta	<input checked="" type="checkbox"/>	355009
---------------	---------------------------------------	-------------------------------------	--------

DISCHI SU FIBRA - ø 115 mm

347.00	6 dischi grana 36	<input checked="" type="checkbox"/>	347004
347.10	6 dischi grana 60	<input checked="" type="checkbox"/>	347103
347.20	6 dischi grana 100	<input checked="" type="checkbox"/>	347202

DISCHI SU FIBRA - ø 180 mm

348.00	6 dischi grana 36	<input checked="" type="checkbox"/>	348001
348.10	6 dischi grana 60	<input checked="" type="checkbox"/>	348100
348.20	6 dischi grana 100	<input checked="" type="checkbox"/>	348209



FOGLI ABRASIVI VELCRO con fori - 93 mm - per levigatrici a DELTA

348.30	5 fogli grana 40	<input checked="" type="checkbox"/>	348308
348.31	25 fogli grana 40	<input type="checkbox"/>	348315
348.35	5 fogli grana 60	<input checked="" type="checkbox"/>	348353
348.36	25 fogli grana 60	<input type="checkbox"/>	348360
348.40	5 fogli grana 80	<input checked="" type="checkbox"/>	348407
348.41	25 fogli grana 80	<input type="checkbox"/>	348414
348.45	5 fogli grana 120	<input checked="" type="checkbox"/>	348452
348.46	25 fogli grana 120	<input type="checkbox"/>	348469
348.50	5 fogli grana 240	<input checked="" type="checkbox"/>	348506
348.51	25 fogli grana 240	<input type="checkbox"/>	348513
348.56	25 fogli grane assortite	<input type="checkbox"/>	348568

DISCHI ABRASIVI VELCRO - ø 115 mm

349.00	10 dischi grana 40	<input checked="" type="checkbox"/>	349008
349.01	25 dischi grana 40	<input type="checkbox"/>	349015
349.10	10 dischi grana 120	<input checked="" type="checkbox"/>	349107
349.11	25 dischi grana 120	<input type="checkbox"/>	349114
349.20	10 dischi grana 240	<input checked="" type="checkbox"/>	349206
349.21	25 dischi grana 240	<input type="checkbox"/>	349213
349.30	10 dischi grane assortite	<input checked="" type="checkbox"/>	349305
349.31	25 dischi grane assortite	<input type="checkbox"/>	349312

DISCHI ABRASIVI VELCRO - ø 125 mm

349.55	10 dischi grana 40	<input checked="" type="checkbox"/>	349558
349.56	25 dischi grana 40	<input type="checkbox"/>	349565
349.60	10 dischi grana 120	<input checked="" type="checkbox"/>	349602
349.61	25 dischi grana 120	<input type="checkbox"/>	349619
349.65	10 dischi grana 240	<input checked="" type="checkbox"/>	349657
349.66	25 dischi grana 240	<input type="checkbox"/>	349664
349.70	10 dischi grane assortite	<input checked="" type="checkbox"/>	349701
349.71	25 dischi grane assortite	<input type="checkbox"/>	349718

DISCHI ABRASIVI VELCRO con fori - ø 115 mm

349.33	10 dischi grana 40	<input checked="" type="checkbox"/>	10	349336
349.34	25 dischi grana 40	<input type="checkbox"/>	1	349343
349.35	10 dischi grana 80	<input checked="" type="checkbox"/>	10	349350
349.36	25 dischi grana 80	<input type="checkbox"/>	1	349367
349.40	10 dischi grana 120	<input checked="" type="checkbox"/>	10	349404
349.41	25 dischi grana 120	<input type="checkbox"/>	1	349411
349.45	10 dischi grana 240	<input checked="" type="checkbox"/>	10	349459
349.46	25 dischi grana 240	<input type="checkbox"/>	1	349466
349.50	10 dischi grane assortite	<input checked="" type="checkbox"/>	10	349503
349.51	25 dischi grane assortite	<input type="checkbox"/>	1	349510

**DISCHI ABRASIVI VELCRO con fori - ø 125 mm**

349.73	10 dischi grana 40	<input checked="" type="checkbox"/>	10	349732
349.74	25 dischi grana 40	<input type="checkbox"/>	1	349749
349.75	10 dischi grana 80	<input checked="" type="checkbox"/>	10	349756
349.76	25 dischi grana 80	<input type="checkbox"/>	1	349763
349.80	10 dischi grana 120	<input checked="" type="checkbox"/>	10	349800
349.81	25 dischi grana 120	<input type="checkbox"/>	1	349817
349.85	10 dischi grana 240	<input checked="" type="checkbox"/>	10	349855
349.86	25 dischi grana 240	<input type="checkbox"/>	1	349862
349.90	10 dischi grane assortite	<input checked="" type="checkbox"/>	10	349909
349.91	25 dischi grane assortite	<input type="checkbox"/>	1	349916

**DISCHI ABRASIVI VELCRO con fori - ø 150 mm**

349.95	10 dischi grana 40	<input checked="" type="checkbox"/>	10	349954
349.96	10 dischi grana 80	<input checked="" type="checkbox"/>	10	349961
349.97	10 dischi grana 120	<input checked="" type="checkbox"/>	10	349978
349.98	10 dischi grana 240	<input checked="" type="checkbox"/>	10	349985
349.99	10 dischi grane assortite	<input checked="" type="checkbox"/>	10	349992



FOGLI DI CARTA ABRASIVA - 230 x 280 mm

355.60	6 fogli grana 60	<input type="checkbox"/>	355603
355.62	6 fogli grana 100	<input type="checkbox"/>	355627
355.64	6 fogli grana 150	<input type="checkbox"/>	355641
355.66	6 fogli grane assortite	<input type="checkbox"/>	355665
FC.01	1 foglio grana 40	<input type="checkbox"/>	083346
FC.03	1 foglio grana 60	<input type="checkbox"/>	083353
FC.04	1 foglio grana 80	<input type="checkbox"/>	083360
FC.05	1 foglio grana 100	<input type="checkbox"/>	083377
FC.06	1 foglio grana 120	<input type="checkbox"/>	083384
FC.07	1 foglio grana 150	<input type="checkbox"/>	083391
FC.08	1 foglio grana 180	<input type="checkbox"/>	083407

FOGLI DI CARTA ABRASIVA IMPERMEABILE - 230 x 280 mm

355.70	6 fogli grana 180	<input type="checkbox"/>	355702
355.72	6 fogli grana 320	<input type="checkbox"/>	355726
355.74	6 fogli grana 600	<input type="checkbox"/>	355740
355.76	6 fogli grane assortite	<input type="checkbox"/>	355764
WSC.01	1 foglio grana 100	<input type="checkbox"/>	085982
WSC.02	1 foglio grana 120	<input type="checkbox"/>	085999
WSC.03	1 foglio grana 150	<input type="checkbox"/>	086002
WSC.04	1 foglio grana 180	<input type="checkbox"/>	086019
WSC.05	1 foglio grana 220	<input type="checkbox"/>	086026
WSC.06	1 foglio grana 240	<input type="checkbox"/>	086033
WSC.07	1 foglio grana 280	<input type="checkbox"/>	086040
WSC.08	1 foglio grana 320	<input type="checkbox"/>	086057
WSC.09	1 foglio grana 360	<input type="checkbox"/>	086064
WSC.10	1 foglio grana 400	<input type="checkbox"/>	086071
WSC.11	1 foglio grana 500	<input type="checkbox"/>	086088
WSC.12	1 foglio grana 600	<input type="checkbox"/>	086095



FOGLI DI TELA AL CORINDONE - 230 x 280 mm

355.80	6 fogli grana 60	10	355801
355.82	6 fogli grana 120	10	355825
355.84	6 fogli grana 240	10	355849
355.86	6 fogli grane assortite	10	355863
T.01	1 foglio grana 30	50	085869
T.03	1 foglio grana 40	50	085876
T.04	1 foglio grana 60	50	085883
T.05	1 foglio grana 80	50	085890
T.06	1 foglio grana 100	50	085906
T.07	1 foglio grana 120	50	085913
T.08	1 foglio grana 150	50	085920
T.09	1 foglio grana 180	50	085937
T.10	1 foglio grana 220	50	085944
T.11	1 foglio grana 240	50	085951
T.12	1 foglio grana 320	50	085968
T.13	1 foglio grana 400	50	085975

**ROTOLO DI CARTA ABRASIVA - 120 mm x 50 yds**

RC.01	grana 40	1	085159
RC.03	grana 60	1	085166
RC.04	grana 80	1	085173
RC.05	grana 100	1	085180
RC.06	grana 120	1	085197
RC.07	grana 150	1	085203
RC.08	grana 180	1	085210
RC.09	grana 240	1	085227



imballo PG



imballo neutro

MINI ROTOLO DI CARTA ABRASIVA - 120 mm x 5 m

355.90	grana 50	<input checked="" type="checkbox"/>	355900
355.92	grana 80	<input checked="" type="checkbox"/>	355924
355.94	grana 120	<input checked="" type="checkbox"/>	355948

MINI ROTOLO DI CARTA ABRASIVA VELCRO - 120 mm x 3 m

355.96	grana 50	<input checked="" type="checkbox"/>	355962
355.97	grana 80	<input checked="" type="checkbox"/>	355979
355.98	grana 120	<input checked="" type="checkbox"/>	355986

FOGLI DI CARTA ABRASIVA - 93 x 230 mm

356.00	10 fogli grana 50	<input checked="" type="checkbox"/>	356006
356.01	25 fogli grana 50	<input type="checkbox"/>	356013
356.10	10 fogli grana 80	<input checked="" type="checkbox"/>	356105
356.11	25 fogli grana 80	<input type="checkbox"/>	356112
356.20	10 fogli grana 120	<input checked="" type="checkbox"/>	356204
356.21	25 fogli grana 120	<input type="checkbox"/>	356211
356.30	10 fogli grane assortite	<input checked="" type="checkbox"/>	356303
356.31	25 fogli grane assortite	<input type="checkbox"/>	356310

FOGLI DI CARTA ABRASIVA - 115 x 280 mm

357.00	10 fogli grana 50	<input checked="" type="checkbox"/>	357003
357.01	25 fogli grana 50	<input type="checkbox"/>	357010
357.10	10 fogli grana 80	<input checked="" type="checkbox"/>	357102
357.11	25 fogli grana 80	<input type="checkbox"/>	357119
357.20	10 fogli grana 120	<input checked="" type="checkbox"/>	357201
357.21	25 fogli grana 120	<input type="checkbox"/>	357218
357.30	10 fogli grane assortite	<input checked="" type="checkbox"/>	357300
357.31	25 fogli grane assortite	<input type="checkbox"/>	357317

FOGLI ABRASIVI VELCRO con fori - 93 x 185 mm

Per Atlas Copco, Bosch, Festo, Holzher, Peugeot

354.00	10 fogli grana 40	5	354002
354.03	10 fogli grana 80	5	354033
354.06	10 fogli grana 120	5	354064
354.09	10 fogli grana 180	5	354095
354.12	10 fogli grana assortite	5	354125

**FOGLI ABRASIVI VELCRO con fori - 93 x 185 mm**

Per Black & Decker KA 186, KA 186E

354.15	10 fogli grana 40	5	354156
354.18	10 fogli grana 80	5	354187
354.21	10 fogli grana 120	5	354217
354.24	10 fogli grana 180	5	354248
354.27	10 fogli grana assortite	5	354279

**FOGLI ABRASIVI con fori - 93 x 230 mm**

Per Bosch, Festo, Makita, Metabo, Peugeot, Ryobi, Skil, Stayer, Wagner

354.30	10 fogli grana 40	5	354309
354.33	10 fogli grana 80	5	354330
354.36	10 fogli grana 120	5	354361
354.39	10 fogli grana 180	5	354392
354.42	10 fogli grana assortite	5	354422



FOGLI ABRASIVI con fori - 93 x 230 mm

Per AEG, Black & Decker, Bosch, Casals, Einhell, Peugeot

354.45	10 fogli grana 40	5	354453
354.48	10 fogli grana 80	5	354484
354.51	10 fogli grana 120	5	354514
354.54	10 fogli grana 180	5	354545
354.57	10 fogli grana assortite	5	354576

FOGLI ABRASIVI VELCRO con fori - 115 x 230 mm

Per AEG, Bosch, Fein, Festo, Holzher, Kress, Mafell, Makita, Peugeot

354.60	10 fogli grana 40	5	354606
354.63	10 fogli grana 80	5	354637
354.66	10 fogli grana 120	5	354668
354.69	10 fogli grana 180	5	354699
354.72	10 fogli grana assortite	5	354729

FOGLI ABRASIVI con fori - 115 x 280 mm

Per AEG, Atlas Copco, Black & Decker, Bosch, Elu, Fein, Festo

354.75	10 fogli grana 40	5	354750
354.78	10 fogli grana 80	5	354781
354.81	10 fogli grana 120	5	354811
354.84	10 fogli grana 180	5	354842
354.87	10 fogli grana assortite	5	354873

NASTRI ABRASIVI - 400 x 60 mm

Per Bosch PBS 60/60E

355.10	3 nastri grana 40	<input checked="" type="checkbox"/>	355108
355.11	3 nastri grana 60	<input checked="" type="checkbox"/>	355115
355.12	3 nastri grana 80	<input checked="" type="checkbox"/>	355122
355.13	3 nastri grana 100	<input checked="" type="checkbox"/>	355139
355.14	3 nastri grana 150	<input checked="" type="checkbox"/>	355146

**NASTRI ABRASIVI - 560 x 100 mm**

Per Atlas Copco, Elu, Ryobi, Festo

355.15	3 nastri grana 40	<input type="checkbox"/>	355153
355.16	3 nastri grana 60	<input type="checkbox"/>	355160
355.17	3 nastri grana 80	<input type="checkbox"/>	355177
355.18	3 nastri grana 100	<input type="checkbox"/>	355184
355.19	3 nastri grana 150	<input type="checkbox"/>	355191

**NASTRI ABRASIVI - 610 x 100 mm**

Per Atlas Copco, Hitachi, Makita, Ryobi, Wolf

355.20	3 nastri grana 40	<input type="checkbox"/>	355207
355.21	3 nastri grana 60	<input type="checkbox"/>	355214
355.22	3 nastri grana 80	<input type="checkbox"/>	355221
355.23	3 nastri grana 100	<input type="checkbox"/>	355238
355.24	3 nastri grana 150	<input type="checkbox"/>	355245

**NASTRI ABRASIVI - 620 x 100 mm**

Per Atlas Copco, Bosch, Makita, Metabo

355.25	3 nastri grana 40	<input type="checkbox"/>	355252
355.26	3 nastri grana 60	<input type="checkbox"/>	355269
355.27	3 nastri grana 80	<input type="checkbox"/>	355276
355.28	3 nastri grana 100	<input type="checkbox"/>	355283
355.29	3 nastri grana 150	<input type="checkbox"/>	355290



imballo PG



imballo neutro

NASTRI ABRASIVI - 533 x 75 mm

Per Bosch PBS 75/75E, Atlas Copco, Metabo, Hitachi, Makita, Holz Her



357.35	3 nastri grana 40	<input type="checkbox"/>	357355
357.36	3 nastri grana 60	<input type="checkbox"/>	357362
357.37	3 nastri grana 80	<input type="checkbox"/>	357379
357.38	3 nastri grana 100	<input type="checkbox"/>	357386
357.39	3 nastri grana 150	<input type="checkbox"/>	357393

NASTRI ABRASIVI - 410 x 65 mm

Per Black & Decker DN 83/BD 83, Atlas Copco HBS 65, Metabo, Holz Her, Kress



357.40	3 nastri grana 40	<input type="checkbox"/>	357409
357.45	3 nastri grana 60	<input type="checkbox"/>	357454
357.50	3 nastri grana 80	<input type="checkbox"/>	357508
357.55	3 nastri grana 100	<input type="checkbox"/>	357553
357.57	3 nastri grana 150	<input type="checkbox"/>	357577

NASTRI ABRASIVI - 510 x 75 mm

Per Black & Decker DN 85/BD 85/SR 500 E



357.60	3 nastri grana 40	<input type="checkbox"/>	357607
357.65	3 nastri grana 60	<input type="checkbox"/>	357652
357.70	3 nastri grana 80	<input type="checkbox"/>	357706
357.75	3 nastri grana 100	<input type="checkbox"/>	357751
357.77	3 nastri grana 150	<input type="checkbox"/>	357775

NASTRI ABRASIVI - 457 x 75 mm

Per B&D KA/85, Stayer LN 75, Skil 1200 H/120 SN, Peugeot, Makita

357.78	3 nastri grana 40	<input type="checkbox"/>	357782
357.79	3 nastri grana 60	<input type="checkbox"/>	357799
357.80	3 nastri grana 80	<input type="checkbox"/>	357805
357.81	3 nastri grana 100	<input type="checkbox"/>	357812
357.82	3 nastri grana 150	<input type="checkbox"/>	357829

SMERIGLIATORE AD ESPANSIONE

357.96	Ø 45 x 30 mm - gambo Ø 6 mm	10	357966
357.98	3 nastri grane assortite per art. 357.96	10	357980

**RUOTA LAMELLARE ABRASIVA - gambo Ø 6 mm - grana 80**

358.40	Ø 40 x 20 mm	10	358406
358.50	Ø 50 x 20 mm	10	358505
358.60	Ø 60 x 40 mm	10	358604
358.80	Ø 80 x 30 mm	10	358802
358.90	40 ruote lamellari abrasive assortite in espositore self-service 15 Ø 40 x 20 mm - 15 Ø 50 x 20 mm 10 Ø 60 x 30 mm	1	358901

**RUOTA LAMELLARE ABRASIVA**

Ø x spessore x gambo	RPM	grana 60		grana 80		grana 120	
		codice	EAN13 8011017	codice	EAN13 8011017	codice	EAN13 8011017
30 x 10 x 6*	22900	RG.002	085241	RG.037	085418	RG.072	085586
30 x 15 x 6*	22900	RG.004	085258	RG.039	085425	RG.074	085593
30 x 20 x 6*	22900	RG.006	085265	RG.041	085432	RG.076	085609
40 x 10 x 6	17100	RG.011	085272	RG.046	085449	RG.081	085616
40 x 15 x 6	17100	RG.012	085289	RG.047	085456	RG.082	085623
40 x 20 x 6	17100	RG.013	085296	RG.048	085463	RG.083	085630
40 x 30 x 6	17100	RG.015	085302	RG.050	085470	RG.085	085647
50 x 20 x 6	13700	RG.019	085319	RG.054	085487	RG.089	085654
50 x 30 x 6	13700	RG.021	085326	RG.056	085494	RG.091	085661
60 x 20 x 6	11400	RG.024	085333	RG.059	085500	RG.094	085678
60 x 30 x 6	11400	RG.026	085340	RG.061	085517	RG.096	085685
60 x 40 x 6	11400	RG.027	085357	RG.062	085524	RG.097	085692
60 x 50 x 6	11400	RG.028	085364	RG.063	085531	RG.098	085708
80 x 15 x 6	8500	RG.029	085371	RG.064	085548	RG.099	085715
80 x 30 x 6	8500	RG.032	085388	RG.067	085555	RG.102	085722
80 x 40 x 6	8500	RG.033	085395	RG.068	085562	RG.103	085739
80 x 50 x 6	8500	RG.034	085401	RG.069	085579	RG.104	085746

* A richiesta disponibili con gambo Ø 3 mm - Confezione: 10 pz.



imballo PG



imballo neutro

DISCO A LAMELLE RADIALI supporto in **NYLON**

358.00	ø 115 mm - foro ø 22 mm - grana 80	<input checked="" type="checkbox"/>	358000
358.10	ø 115 mm - foro ø 22 mm - grana 40	<input type="checkbox"/>	358109
358.15	ø 115 mm - foro ø 22 mm - grana 80	<input type="checkbox"/>	358154
358.20	ø 115 mm - foro ø 22 mm - grana 120	<input type="checkbox"/>	358208

DISCO A LAMELLE RADIALI supporto in **NYLON**

358.05	ø 180 mm - foro ø 22 mm - grana 80	<input checked="" type="checkbox"/>	358055
358.25	ø 180 mm - foro ø 22 mm - grana 40	<input type="checkbox"/>	358253
358.30	ø 180 mm - foro ø 22 mm - grana 80	<input type="checkbox"/>	358307
358.35	ø 180 mm - foro ø 22 mm - grana 120	<input type="checkbox"/>	358352

DISCO A LAMELLE RADIALI supporto in **FIBRA**

359.00	ø 115 mm - foro ø 22 mm - grana 80	<input checked="" type="checkbox"/>	359007
359.10	ø 115 mm - foro ø 22 mm - grana 40	<input type="checkbox"/>	359106
359.15	ø 115 mm - foro ø 22 mm - grana 80	<input type="checkbox"/>	359151
359.20	ø 115 mm - foro ø 22 mm - grana 120	<input type="checkbox"/>	359205

DISCO A LAMELLE RADIALI supporto in **FIBRA**

359.05	ø 180 mm - foro ø 22 mm - grana 80	<input checked="" type="checkbox"/>	359052
359.25	ø 180 mm - foro ø 22 mm - grana 40	<input type="checkbox"/>	359250
359.30	ø 180 mm - foro ø 22 mm - grana 80	<input type="checkbox"/>	359304
359.35	ø 180 mm - foro ø 22 mm - grana 120	<input type="checkbox"/>	359359

DISCO METALLICO AL TUNGSTENO - ø 125 mm

345.10	grana media	<input checked="" type="checkbox"/>	345109
345.20	grana fine	<input checked="" type="checkbox"/>	345208

MOLA AFFILATRICE per forbici, lame e coltelli

395.00	Ø 50 mm - gambo ch. 7 mm	10	395005
---------------	--------------------------	----	--------

**COTE** per affilare falci, coltelli e forbici

395.20	230 mm	10	395203
395.40	230 mm	10/100	395401

**MOLE SU PERNO IN CORINDONE ROSA**

Per metallo, vetro, ceramica e materie sintetiche

396.00	100 mole assortite - gambo Ø 6 mm in espositore self-service	1	396002
397.00	45 mole assortite - gambo Ø 3/6 mm in espositore	1	397009
397.20	48 mole assortite forma cilindrica - gambo Ø 3 mm in espositore	1	397207
397.30	48 mole assortite - gambo Ø 3 mm in espositore	1	397306
397.60	3 mole assortite per l'affilatura di seghe a catena - gambo Ø 3 mm	10	397603
398.00	5 mole assortite - gambo Ø 3 mm	10	398006
399.00	5 mole assortite - gambo Ø 6 mm	10	399003



**MOLA SU PERNO IN CORINDONE ROSA
FORMA CILINDRICA TIPO A**

2 x 6 x 3	MA.001	083681	12 x 20 x 6	MA.019	083865	30 x 25 x 6	MA.037	084046
3 x 6 x 3	MA.002	083698	12 x 30 x 6	MA.020	083872	30 x 30 x 6	MA.038	084053
4 x 8 x 3	MA.003	083704	15 x 15 x 6	MA.021	083889	30 x 40 x 6	MA.039	084060
5 x 10 x 3	MA.004	083711	15 x 20 x 6	MA.022	083896	35 x 20 x 6	MA.040	084077
6 x 10 x 3	MA.005	083728	15 x 25 x 6	MA.023	083902	35 x 25 x 6	MA.041	084084
8 x 10 x 3	MA.006	083735	15 x 30 x 6	MA.024	083919	35 x 35 x 6	MA.042	084091
10 x 10 x 3	MA.007	083742	15 x 40 x 6	MA.025	083926	40 x 20 x 6	MA.043	084107
12 x 12 x 3	MA.008	083759	20 x 15 x 6	MA.026	083933	40 x 25 x 6	MA.044	084114
15 x 15 x 3	MA.009	083766	20 x 20 x 6	MA.027	083940	40 x 30 x 6	MA.045	084121
4 x 8 x 6	MA.010	083773	20 x 25 x 6	MA.028	083957	40 x 40 x 6	MA.046	084138
5 x 10 x 6	MA.011	083780	20 x 30 x 6	MA.029	083964	50 x 25 x 6	MA.047	084145
6 x 10 x 6	MA.012	083797	20 x 40 x 6	MA.030	083971	50 x 30 x 6	MA.048	084152
8 x 10 x 6	MA.013	083803	25 x 15 x 6	MA.031	083988	50 x 40 x 6	MA.049	084169
10 x 10 x 6	MA.014	083810	25 x 20 x 6	MA.032	083995			
10 x 15 x 6	MA.015	083827	25 x 25 x 6	MA.033	084008			
10 x 20 x 6	MA.016	083834	25 x 30 x 6	MA.034	084015			
10 x 30 x 6	MA.017	083841	25 x 40 x 6	MA.035	084022			
12 x 12 x 6	MA.018	083858	30 x 20 x 6	MA.036	084039			

FORMA A PUNTA TIPO B

10 x 15 x 3	MB.001	084190	15 x 25 x 6	MB.004	084220	30 x 40 x 6	MB.007	084251
10 x 15 x 6	MB.002	084206	20 x 30 x 6	MB.005	084237			
10 x 20 x 6	MB.003	084213	25 x 30 x 6	MB.006	084244			

FORMA CILINDRICA CONICA TIPO C

6 x 8 x 3	MC.001	084268	10 x 15 x 6	MC.005	084305	20 x 30 x 6	MC.009	084343
8 x 12 x 3	MC.002	084275	10 x 20 x 6	MC.006	084312	20 x 40 x 6	MC.010	084350
8 x 12 x 6	MC.003	084282	15 x 20 x 6	MC.007	084329	25 x 40 x 6	MC.011	084367
8 x 20 x 6	MC.004	084299	15 x 25 x 6	MC.008	084336	30 x 40 x 6	MC.012	084374

FORMA PIATTA TIPO D

10 x 3,5 x 3	MD.001	084381	30 x 6 x 6	MD.008	084459	40 x 15 x 6	MD.015	084527
10 x 5 x 3	MD.002	084398	30 x 10 x 6	MD.009	084466	50 x 10 x 6	MD.016	084534
15 x 4 x 3	MD.003	084404	30 x 15 x 6	MD.010	084473	50 x 15 x 6	MD.017	084541
20 x 4 x 3	MD.004	084411	35 x 8 x 6	MD.011	084480	60 x 10 x 6	MD.018	084558
20 x 10 x 6	MD.005	084428	35 x 12 x 6	MD.012	084497	70 x 10 x 6	MD.019	084565
25 x 5 x 6	MD.006	084435	40 x 6 x 6	MD.013	084503			
25 x 10 x 6	MD.007	084442	40 x 10 x 6	MD.014	084510			

FORMA A SFERA TIPO E

4 x 3	ME.001	084572	10 x 3	ME.004	084602	20 x 6	ME.007	084633
6 x 3	ME.002	084589	10 x 6	ME.005	084619	25 x 6	ME.008	084640
8 x 3	ME.003	084596	15 x 6	ME.006	084626	30 x 6	ME.009	084657

∅
spessore
· gambo

codice

EAN13
8011017

∅
spessore
· gambo

codice

EAN13
8011017

∅
spessore
· gambo

codice

EAN13
8011017

**TRONCATURA E
SMERIGLIATURA**

MOLA SU PERNO IN CORINDONE ROSA FORMA CONICA TIPO F

8 x 12 x 3	MF.001	084671	20 x 25 x 6	MF.004	084701	30 x 40 x 6	MF.007	084732
10 x 15 x 3	MF.002	084688	25 x 30 x 6	MF.005	084718			
10 x 15 x 6	MF.003	084695	30 x 30 x 6	MF.006	084725			

FORMA ARROTONDATA TIPO G

20 x 10 x 6	MG.001	084756	40 x 10 x 6	MG.003	084770			
30 x 10 x 6	MG.002	084763	40 x 20 x 6	MG.004	084787			

FORMA DOPPIO SMUSSO TIPO H

20 x 6 x 6	MH.001	084794	40 x 10 x 6	MH.003	084817			
30 x 10 x 6	MH.002	084800	50 x 10 x 6	MH.004	084824			

FORMA SEMISFERICA TIPO I

10 x 10 x 3	MI.001	084831	15 x 15 x 6	MI.004	084862	30 x 30 x 6	MI.007	084893
10 x 20 x 6	MI.002	084848	20 x 20 x 6	MI.005	084879			
12 x 12 x 6	MI.003	084855	25 x 25 x 6	MI.006	084886			

FORMA AD OGIVA TIPO L

6 x 10 x 3	ML.001	084916	10 x 15 x 6	ML.004	084947	18 x 32 x 6	ML.007	084978
8 x 10 x 3	ML.002	084923	12 x 20 x 6	ML.005	084954	20 x 40 x 6	ML.008	084985
8 x 10 x 6	ML.003	084930	15 x 20 x 6	ML.006	084961			

FORMA CONO ROVESCIATO TIPO M

10 x 20 x 3	MM.001	084992	20 x 20 x 6	MM.004	085029	30 x 30 x 6	MM.007	085050
12 x 20 x 6	MM.002	085005	20 x 30 x 6	MM.005	085036	40 x 20 x 6	MM.008	085067
15 x 20 x 6	MM.003	085012	30 x 20 x 6	MM.006	085043	40 x 30 x 6	MM.009	085074

FORMA TRONCO-CONICA TIPO N

8 x 10 x 3	MN.001	085081	12 x 20 x 6	MN.004	085111	25 x 40 x 6	MN.007	085142
8 x 15 x 3	MN.002	085098	15 x 25 x 6	MN.005	085128			
10 x 15 x 6	MN.003	085104	20 x 30 x 6	MN.006	085135			

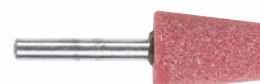
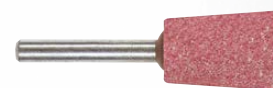
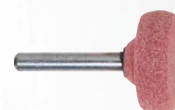

Confezione: **10** pz.



imballo PG



imballo neutro

MOLA ABRASIVA IN CORINDONE GRIGIO

400.00	Ø 75 x 10 mm - foro Ø 10 mm	<input type="checkbox"/>	400006
402.00	Ø 75 x 10 mm - foro Ø 13 mm	<input type="checkbox"/>	402000
403.00	Ø 75 x 10 mm - foro Ø 13 mm - CARBURO DI SILICIO	<input type="checkbox"/>	403007
404.00	Ø 100 x 12 mm - foro Ø 13 mm	<input type="checkbox"/>	404004
404.50	Ø 125 x 15 mm - foro Ø 16 mm	<input type="checkbox"/>	404509
405.00	Ø 150 x 20 mm - foro Ø 16 mm	<input type="checkbox"/>	405001

MOLA TRONCATRICE per metallo

406.00	Ø 125 x 2,5 mm - foro Ø 13 mm	<input type="checkbox"/>	406008
406.95	Ø 115 x 1,0 mm - foro Ø 22 mm	<input type="checkbox"/>	406954
407.00	Ø 115 x 1,6 mm - foro Ø 22 mm	<input type="checkbox"/>	407005
407.05	Ø 115 x 1,6 mm - foro Ø 22 mm	<input type="checkbox"/>	407050

MOLA TRONCATRICE per marmo

408.00	Ø 125 x 2,5 mm - foro Ø 13 mm	<input type="checkbox"/>	408002
409.00	Ø 115 x 1,6 mm - foro Ø 22 mm	<input type="checkbox"/>	409009
409.05	Ø 115 x 1,6 mm - foro Ø 22 mm	<input type="checkbox"/>	409054

MOLA RESINOIDE A CENTRO DEPRESSO per metallo

100 x 3,0 x 16	411.05	-	50	411057
100 x 4,8 x 16	-	412.05	50	412054
115 x 3,2 x 22	413.00	-	10	413006
115 x 3,2 x 22	413.05	-	10	413051
115 x 6,4 x 22	-	414.00	10	414003
115 x 6,4 x 22	-	414.05	10	414058
125 x 3,0 x 22	415.05	-	50	415055
125 x 6,4 x 22	-	416.05	50	416052
150 x 3,2 x 22	416.60	-	25	416601
150 x 6,4 x 22	-	416.80	25	416809
178 x 3,2 x 22	417.00	-	25	417004
178 x 6,4 x 22	-	417.30	25	417301
230 x 3,2 x 22	418.00	-	25	418001
230 x 6,4 x 22	-	418.30	25	418308



MOLA RESINOIDE A CENTRO DEPRESSO per marmo e laterizi

100 x 3,0 x 16	411.55	-	50	411552
100 x 4,8 x 16	-	412.55	50	412559
115 x 3,2 x 22	413.50	-	10	413501
115 x 3,2 x 22	413.55	-	10	413556
115 x 6,4 x 22	-	414.50	10	414508
115 x 6,4 x 22	-	414.55	10	414553
125 x 3,0 x 22	415.55	-	50	415550
125 x 6,4 x 22	-	416.50	25	416502
150 x 3,2 x 22	416.70	-	25	416700
150 x 6,4 x 22	-	416.90	25	416908
178 x 3,2 x 22	417.10	-	25	417103
178 x 6,4 x 22	-	417.50	25	417509
230 x 3,2 x 22	418.10	-	25	418100
230 x 6,4 x 22	-	418.50	25	418506





MOLA AD IMPASTO CERAMICO

A96 CORINDONE GRIGIO

**C49 VERDE
CARBURO
DI SILICIO**

dimensioni Ø x spessore x foro	grane						grana	
	24	36	46	60	80	100		
75 x 10 x 10				A96.053	A96.078	A96.102		C49.010
75 x 12 x 13				A96.054	A96.079	A96.103		C49.011
100 x 10 x 13				A96.055	A96.080	A96.104		
100 x 13 x 13		A96.204	A96.209	A96.056	A96.214	A96.105		C49.012
100 x 15 x 13	A96.199	A96.205	A96.210	A96.057	A96.082	A96.106		C49.013
100 x 20 x 13	A96.200	A96.206	A96.211	A96.058	A96.083	A96.107		C49.050
125 x 13 x 16		A96.157	A96.166	A96.175	A96.185	A96.191		
125 x 15 x 16	A96.149	A96.158	A96.167	A96.176	A96.186	A96.192		C49.034
125 x 20 x 16	A96.150	A96.127	A96.168	A96.177	A96.187	A96.193		C49.035
125 x 25 x 16	A96.151	A96.160	A96.169	A96.178	A96.188	A96.194		
150 x 16 x 16	A96.001	A96.019	A96.038	A96.063	A96.088	A96.112		C49.051
150 x 20 x 16	A96.002	A96.020	A96.039	A96.064	A96.089	A96.113		C49.016
150 x 20 x 32		A96.207		A96.212				
150 x 25 x 16	A96.003	A96.021	A96.040	A96.065	A96.090	A96.114		C49.017
150 x 30 x 16	A96.004	A96.022	A96.041	A96.066	A96.091	A96.115		
175 x 20 x 20	A96.005	A96.023	A96.042	A96.067	A96.092	A96.116		C49.018
175 x 25 x 20	A96.006	A96.024	A96.043	A96.068	A96.093	A96.117		C49.052
200 x 20 x 20	A96.008	A96.026	A96.045	A96.070	A96.095	A96.119		C49.019
200 x 20 x 32		A96.208		A96.213				
200 x 25 x 20	A96.009	A96.027	A96.046	A96.071	A96.096	A96.120		C49.020
200 x 30 x 20	A96.010	A96.028	A96.047	A96.072	A96.097	A96.121		C49.053
250 x 25 x 25	A96.011	A96.029	A96.048	A96.073	A96.098	A96.122		C49.054
250 x 30 x 25	A96.012	A96.030	A96.049	A96.074	A96.099	A96.123		C49.055
300 x 30 x 30	A96.013	A96.031	A96.050	A96.075	A96.100	A96.124		
300 x 35 x 30	A96.147	A96.155	A96.164	A96.173	A96.182			
300 x 40 x 30	A96.014	A96.032	A96.051	A96.076	A96.101			
400 x 50 x 40	A96.148	A96.033	A96.052	A96.077	A96.184			

Confezione: pz.

imballo PG imballo neutro

MOLA CON PROFILO «C» PER AFFILATURA SEGHE - grana 80

dimensioni	A96 grigio		A99 bianco		dimensioni	A96 grigio		A99 bianco	
∅ x spessore x foro	codice		codice		∅ x spessore x foro	codice		codice	
125 x 6 x 16	A96C.01		A99C.01		175 x 8 x 20	A96C.08		A99C.08	
125 x 7 x 16	A96C.02		A99C.02		175 x 10 x 20	A96C.09		A99C.09	
125 x 8 x 16	A96C.03		A99C.03		200 x 6 x 20	A96C.10		A99C.10	
150 x 6 x 16	A96C.04		A99C.04		200 x 8 x 20	A96C.11		A99C.11	
150 x 7 x 16	A96C.05		A99C.05		200 x 10 x 20	A96C.12		A99C.12	
150 x 8 x 16	A96C.06		A99C.06		200 x 12 x 20	A96C.14			
150 x 10 x 16	A96C.13		A99C.13		250 x 10 x 25	A96C.15			
175 x 6 x 20	A96C.07		A99C.07		250 x 13 x 25	A96C.16			



BASTONCINO A RAVVIVAMOLA C48 20T in carburo di silicio nero

dimensioni	codice
150 x 20	C48.01
200 x 20	C48.02
200 x 25	C48.03

 Confezione: **8** pz.

PIETRA A DOPPIA GRANA
per affilatura ad olio di utensili

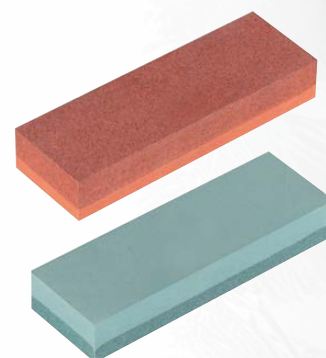
dimensioni	C49 verde grana 120/400		A99 rosa grana 150/320	
	lung. x larg. x spess.	codice	codice	
125 x 50 x 20	DG.01		DG.03	
150 x 50 x 25	DG.02		DG.04	

 Confezione: **4** pz.

LIMA ABRASIVA in corindone rosa

dimensioni	grana 80		grana 120		grana 220		FORMA
	codice		codice		codice		
100 x 13	LTR.001		LTR.004		LTR.007		triangolare
150 x 16	LTR.002		LTR.005		LTR.008		
200 x 20	LTR.003		LTR.006		LTR.009		
100 x 13	LTO.001		LTO.004		LTO.007		mezza-tonda
150 x 16	LTO.002		LTO.005		LTO.008		
200 x 20	LTO.003		LTO.006		LTO.009		
100 x 13	LQU.001		LQU.004		LQU.007		quadrata
150 x 16	LQU.002		LQU.005		LQU.008		
200 x 20	LQU.003		LQU.006		LQU.009		

 Confezione: **10** pz.

imballo PG



imballo neutro

DISCO DIAMANTATO UNIVERSALE TURBO DA TAGLIO

Per tagliare cemento armato, klinker, mezzi mattoni, granito

419.60	Ø 115 mm - foro Ø 22 mm	1	419602
419.65	Ø 230 mm - foro Ø 22 mm	1	419657

DISCO DIAMANTATO SEGMENTATO DA TAGLIO

Per tagliare laterizio, pietre per muratura naturali, pietre per pavimentazioni, piastrelle per marciapiedi

419.70	Ø 115 mm - foro Ø 22 mm	1	419701
419.75	Ø 230 mm - foro Ø 22 mm	1	419756

DISCO DIAMANTATO A CORONA CONTINUA DA TAGLIO

Per tagliare mattonelle, piastrelle in ceramica, mezzi mattoni, marmo

419.80	Ø 115 mm - foro Ø 22 mm	1	419800
419.85	Ø 230 mm - foro Ø 22 mm	1	419855

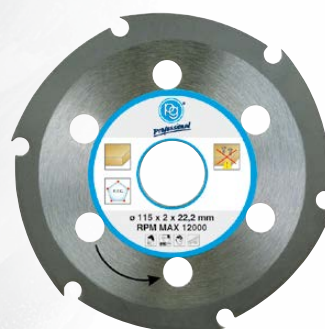
DISCO DA TAGLIO

Per fresare, tagliare e smussare il legno e lavorare PVC e altri materiali plastici

419.90	Ø 115 mm - foro Ø 22 mm	5	419909
419.95	Ø 230 mm - foro Ø 22 mm	1	419954

FRESA SAGOMATA - gambo \varnothing 8 mm

360.00	\varnothing 35 mm per profilo mezzo tondo interno 45°		5	360003
361.00	\varnothing 35 mm per profilo mezzo tondo esterno 45°		5	361000
362.00	\varnothing 35 mm per profilo concavo		5	362007
363.00	\varnothing 35 mm per profilo convesso		5	363004
364.00	\varnothing 25 x 22 mm cilindrica per levigare		5	364001
364.50	\varnothing 25 x 22 mm per profilo tondo		5	364506
365.00	\varnothing 35 mm conica 45°		5	365008
366.00	\varnothing 35 x 5 mm per scanalatura		5	366005
367.00	\varnothing 30 x 22 mm doppia battuta per incastri		5	367002
368.00	\varnothing 30 x 1,5 mm per intagli		5	368009
369.00	\varnothing 30 x 2,5 mm per intagli		5	369006
370.00	\varnothing 45 x 1,5 mm circolare a sega		5	370002
372.00	\varnothing 6 mm a dito per mortasare		5	372006

**FRESATRICE UNIVERSALE** per l'utilizzo di tutte le frese sagomate

373.00	fresatrice regolabile completa di fresa \varnothing 45 mm - CE	1	373003
---------------	--	---	--------

**PUNTA-FRESA REGOLABILE PER SVASARE** con arresto di profondità

374.03	\varnothing 3 mm	10	374031
374.04	\varnothing 4 mm	10	374048
374.05	\varnothing 5 mm	10	374055
374.06	\varnothing 6 mm	10	374062



FRESA PER SVASARE - gambo ø 6 mm

375.00	ø 6 mm	10	375007
376.00	ø 12 mm	10	376004
377.00	ø 16 mm	10	377001
378.00	ø 19 mm	10	378008

**FRESA PER SVASARE AD OMBRELLO - gambo ø 5 mm**

379.00	ø 13 mm	10	379005
---------------	---------	----	--------

**FRESA PER SVASARE - gambo ch. 1/4"**

451.10	ø 10 mm	5	451107
451.20	ø 13 mm	5	451206
451.30	ø 16 mm	5	451305

**FRESA PER SVASARE MANUALE**

451.00	ø 12 mm - a 5 tagli	10	451008
---------------	---------------------	----	--------

**FRESA PER CERNIERA - gambo ø 8 mm**

379.50	ø 20 mm	10	379500
380.00	ø 26 mm	10	380001
381.00	ø 30 mm	10	381008
382.00	ø 35 mm	10	382005
383.00	ø 38 mm	10	383002

**FRESA PER CERNIERA IN METALLO DURO - gambo ø 8 mm**

384.00	ø 26 mm	5	384009
384.10	ø 30 mm	5	384108
384.20	ø 35 mm	5	384207



MECCHIA per legno - gambo ø 6 mm

384.50	ø 6 mm	10	384504
385.00	ø 8 mm	10	385006
386.00	ø 10 mm	10	386003
387.00	ø 12 mm	10	387000
388.00	ø 14 mm	10	388007
389.00	ø 16 mm	10	389004
390.00	ø 18 mm	10	390000
391.00	ø 20 mm	10	391007
392.00	ø 22 mm	10	392004
392.50	ø 24 mm	10	392509
393.00	ø 25 mm	10	393001
393.20	ø 26 mm	10	393209
393.40	ø 28 mm	10	393407
393.60	ø 30 mm	10	393605
394.00	ø 32 mm	10	394008
394.20	ø 35 mm	10	394206
394.40	ø 38 mm	10	394404

**MECCHIA REGOLABILE** per legno

394.70	ø 15/45 mm - gambo ø 6 mm	2	394701
394.80	ø 22/76 mm - gambo ø 10 mm	2	394800

**PROLUNGA PER MECCHIE** - gambo ø 6 mm

394.84	150 mm	5	394848
394.86	300 mm	5	394862



imballo PG



imballo neutro

PUNTA FORSTNER - DIN 7483

 lunghezza **90 mm** - gambo \varnothing **8 mm**

12.010	\varnothing 10 mm	1	120102
12.012	\varnothing 12 mm	1	120126
12.014	\varnothing 14 mm	1	120140
12.015	\varnothing 15 mm	1	120157
12.016	\varnothing 16 mm	1	120164
12.018	\varnothing 18 mm	1	120188
12.020	\varnothing 20 mm	1	120201
12.022	\varnothing 22 mm	1	120225
12.024	\varnothing 24 mm	1	120249
12.025	\varnothing 25 mm	1	120256
12.026	\varnothing 26 mm	1	120263
12.028	\varnothing 28 mm	1	120287
12.030	\varnothing 30 mm	1	120300
12.032	\varnothing 32 mm - gambo \varnothing 10 mm	1	120324
12.034	\varnothing 34 mm - gambo \varnothing 10 mm	1	120348
12.035	\varnothing 35 mm - gambo \varnothing 10 mm	1	120355
12.036	\varnothing 36 mm - gambo \varnothing 10 mm	1	120362
12.040	\varnothing 40 mm - gambo \varnothing 10 mm	1	120409
12.045	\varnothing 45 mm - gambo \varnothing 10 mm	1	120454
12.050	\varnothing 50 mm - gambo \varnothing 10 mm	1	120508

LIMA ROTATIVA per metallo - gambo \varnothing 6 mm

420.00	lima cilindrica	10	420004
422.00	lima conica	10	422008
424.00	lima cilindrica bombata	10	424002
426.00	lima sferica	10	426006
445.00	punta - fresa HSS \varnothing 6 x 85 mm	10	445007

**LIMA ROTATIVA** per metallo - gambo ch. 1/4"

445.20	lima conica	5	445205
445.30	lima cilindrica bombata	5	445304

**RASPA ROTATIVA** per legno - gambo \varnothing 6 mm

430.00	raspa cilindrica	10	430003
432.00	raspa conica	10	432007
434.00	raspa sferica	10	434001
436.00	raspa conica bombata	10	436005
438.00	fresa per svasare	10	438009
440.00	punta - raspa \varnothing 6 x 90 mm	10	440002

**RASPA ROTATIVA** per legno - gambo ch. 1/4"

440.20	raspa conica	5	440200
440.40	raspa cilindrica bombata	5	440408

**ASSORTIMENTO FRESE E RASPE** - gambo \varnothing 6 mm

446.00	3 mini frese e raspe assortite	10	446004
447.00	6 frese e raspe assortite	5	447001



FRESA - RASPA ROTATIVA per legno - gambo \varnothing 6 mm

448.00	\varnothing 10/15 mm	10	448008
448.10	\varnothing 15/20 mm	10	448107
448.20	\varnothing 20/25 mm	10	448206

LIMA - RASPA per metallo e legno

449.06	lunghezza 6" - 150 mm	10	449067
449.08	lunghezza 8" - 200 mm	10	449081

LIME per metallo - lunghezza 4" - 100 mm

449.20	6 lime forma piatta parallela - piatta a punta - mezzatonda - tonda - a triangolo - quadra	5	449203
---------------	--	---	--------

LIME TONDE per seghe a catena - lunghezza 8" - 200 mm

449.40	2 lime \varnothing 5/32" - 4,0 mm	10	449401
449.45	12 lime \varnothing 5/32" - 4,0 mm	2	449456
449.50	2 lime \varnothing 3/16" - 4,8 mm	10	449500
449.55	12 lime \varnothing 3/16" - 4,8 mm	2	449555
449.60	2 lime \varnothing 7/32" - 5,6 mm	10	449609
449.65	12 lime \varnothing 7/32" - 5,6 mm	2	449654

PORTA INSERTI MAGNETICOPer inserti con attacco esagonale **1/4"**

452.00	gambo ch. 1/4" - lunghezza 60 mm	10	452005
452.05	a rilascio rapido - gambo ch. 1/4" - lunghezza 60 mm	5	452050
452.10	con regolazione di profondità - gambo ch. 1/4" - lunghezza 60 mm - per cartongesso	5	452104
452.15	flessibile - gambo ch. 1/4" - lunghezza 190 mm	5	452159
452.20	attacco SDS plus - lunghezza 75 mm	5	452203

**AVVITATORE A SQUADRA**

452.30	con porta inserti esagonale 1/4"	5	452302
---------------	---	---	--------

**INSERTI PER VITI TORX - lunghezza 25 mm**

452.40	2 inserti T10	10	452401
452.50	2 inserti T15	10	452500
452.60	2 inserti T20	10	452609
452.70	2 inserti T25	10	452708
452.80	2 inserti T30	10	452807
452.90	2 inserti T40	10	452906

**INSERTI AL TITANIO PER VITI TORX - lunghezza 25 mm**

452.92	2 inserti T10	5	452920
452.93	2 inserti T15	5	452937
452.94	2 inserti T20	5	452944
452.95	2 inserti T25	5	452951
452.96	2 inserti T30	5	452968
452.97	2 inserti T40	5	452975



imballo PG



imballo neutro

INSERTI PER VITI A CAVA ESAGONALE - lunghezza 25 mm

453.00	2 inserti 2 mm	10	453002
453.10	2 inserti 2,5 mm	10	453101
453.20	2 inserti 3 mm	10	453200
453.30	2 inserti 4 mm	10	453309
453.40	2 inserti 5 mm	10	453408
453.50	2 inserti 6 mm	10	453507

INSERTI PHILLIPS - lunghezza 25 mm

454.00	2 inserti n. 1	10	454009
455.00	2 inserti n. 2	10	455006
456.00	2 inserti n. 3	10	456003
456.20	1 inserto n. 4	10	456201

INSERTI PHILLIPS AL TITANIO - lunghezza 25 mm

456.50	2 inserti n. 1	5	456508
456.52	2 inserti n. 2	5	456522
456.54	2 inserti n. 3	5	456546

INSERTI TAGLIO - lunghezza 25 mm

457.00	2 inserti 0,8 x 4 mm	10	457000
458.00	2 inserti 0,8 x 5 mm	10	458007
459.00	2 inserti 1,0 x 6 mm	10	459004
459.20	2 inserti 1,2 x 7,2 mm	10	459202
459.40	2 inserti 1,6 x 8 mm	10	459400

INSERTI TAGLIO AL TITANIO - lunghezza 25 mm

459.50	2 inserti 0,8 x 4 mm	5	459509
459.52	2 inserti 0,8 x 5 mm	5	459523
459.54	2 inserti 1,0 x 6 mm	5	459547

INSERTI POZIDRIV - lunghezza **25** mm

459.90	2 inserti n. 0	10	459905
460.00	2 inserti n. 1	10	460000
460.10	2 inserti n. 2	10	460109
460.20	2 inserti n. 3	10	460208
460.30	1 inserto n. 4	10	460307

**INSERTI POZIDRIV AL TITANIO** - lunghezza **25** mm

460.50	2 inserti n. 0	5	460505
460.52	2 inserti n. 1	5	460529
460.54	2 inserti n. 2	5	460543
460.56	2 inserti n. 3	5	460567

**INSERTO A DOPPIO INTAGLIO** - lunghezza **60** mm

461.00	taglio 0,8 x 4 mm + Phillips n. 1	10	461007
462.00	taglio 0,8 x 5 mm + Phillips n. 2	10	462004
462.50	taglio 1,2 x 7,2 mm + Phillips n. 3	10	462509

**KIT INSERTI ASSORTITI**

463.00	7 pezzi: porta inserti magnetico + Phillips 1 - 2 + Pozidriv 1 - 2 + taglio 4 - 5 mm	5	463001
463.50	7 pezzi: porta inserti magnetico + Torx T10 - T15 - T20 - T25 - T30 - T40	5	463506
464.00	10 pezzi: porta inserti magnetico + Phillips 1 - 2 - 3 + Pozidriv 1 - 2 - 3 + taglio 4 - 5 - 6 mm	5	464008
PG32A	32 pezzi: porta inserti magnetico ad attacco rapido + Phillips 1 - 2 - 2 - 3 + Pozidriv 1 - 2 - 2 - 3 + taglio 3 - 4 - 5 - 6 mm + esagonali 3 - 4 - 5 - 6 mm + Torx T10 - T15 - T20 - T25 - T27 - T30 - T40 + Torx foro T10 - T15 - T20 - T25 - T27 - T30 - T40 + adattatore attacco 1/4" esagonale a 1/4" quadro	1	071046





SPAZZOLA CIRCOLARE in filo d'ottone - gambo \varnothing **6** mm

490.00	\varnothing 75 mm	<input checked="" type="checkbox"/>	10	490007
---------------	----------------------------	-------------------------------------	----	--------



SPAZZOLA A TAZZA in filo d'ottone - gambo \varnothing **6** mm

495.00	\varnothing 50 mm	<input checked="" type="checkbox"/>	10	495002
---------------	----------------------------	-------------------------------------	----	--------



SPAZZOLA CIRCOLARE CONICA in filo d'acciaio - gambo \varnothing **6** mm

466.00	\varnothing 90 mm	<input checked="" type="checkbox"/>	10	466002
466.01	20 spazzole art. 466.00 sfuse	<input type="checkbox"/>	1	466019



SPAZZOLA CIRCOLARE CONICA in filo d'acciaio - foro **M14**

467.00	\varnothing 90 mm	<input checked="" type="checkbox"/>	10	467009
467.01	20 spazzole art. 467.00 sfuse	<input type="checkbox"/>	1	467016
468.00	\varnothing 120 mm	<input checked="" type="checkbox"/>	10	468006
468.01	20 spazzole art. 468.00 sfuse	<input type="checkbox"/>	1	468013
468.20	\varnothing 150 mm	<input checked="" type="checkbox"/>	5	468204
468.30	\varnothing 100 mm - a mazzetti ritorti	<input checked="" type="checkbox"/>	5	468303
468.35	\varnothing 120 mm - a mazzetti ritorti	<input checked="" type="checkbox"/>	5	468358
468.40	\varnothing 150 mm - a mazzetti ritorti	<input checked="" type="checkbox"/>	5	468402



SPAZZOLA CIRCOLARE in filo d'acciaio - gambo ø 6 mm

468.50	ø 40 mm	10	468501
468.51	20 spazzole art. 468.50 sfuse	1	468518
469.00	ø 50 mm	10	469003
469.01	20 spazzole art. 469.00 sfuse	1	469010
470.00	ø 75 mm	10	470009
470.01	20 spazzole art. 470.00 sfuse	1	470016
470.50	ø 75 mm - doppio spessore	10	470504
475.00	ø 100 mm	10	475004
475.01	20 spazzole art. 475.00 sfuse	1	475011
475.50	ø 100 mm - doppio spessore	10	475509
475.65	ø 75 mm - a mazzetti ritorti	5	475653
475.70	ø 100 mm - a mazzetti ritorti	5	475707

**SPAZZOLA CIRCOLARE** in filo d'acciaio

485.80	ø 75 mm - foro ø 13 mm	10	485805
486.00	ø 100 mm - foro ø 13 mm	10	486000
487.00	ø 120 mm - foro ø 16 mm	10	487007
488.00	ø 150 mm - foro ø 32/20/16 mm	10	488004
489.00	ø 200 mm - foro ø 32/20/16 mm spessore 20 mm	1	489001
489.50	ø 200 mm - foro ø 32/20/16 mm spessore 40 mm	1	489506



imballo PG



imballo neutro

MINI SPAZZOLE in filo d'acciaio - gambo ø **2,35** mm

476.00	3 mini spazzole assortite - ø 5 - 12 - 21 mm	<input checked="" type="checkbox"/>	476001
---------------	--	-------------------------------------	--------

SPAZZOLA A PENNELLO in filo d'acciaio - gambo ø **6** mm

477.00	ø 16 mm	<input checked="" type="checkbox"/>	477008
477.01	20 spazzole art. 477.00 sfuse	<input type="checkbox"/>	477015
478.00	ø 25 mm	<input checked="" type="checkbox"/>	478005
478.01	20 spazzole art. 478.00 sfuse	<input type="checkbox"/>	478012

SPAZZOLA A FUNGO in filo d'acciaio - gambo ø **6** mm

478.20	ø 30 mm	<input checked="" type="checkbox"/>	478203
478.40	ø 40 mm	<input checked="" type="checkbox"/>	478401

SPAZZOLA A SCOVOLO in filo d'acciaio - gambo ø **6** mm

478.80	ø 16 mm	<input checked="" type="checkbox"/>	478807
478.90	ø 20 mm	<input checked="" type="checkbox"/>	478906
479.00	ø 28 mm	<input checked="" type="checkbox"/>	479002
479.01	20 spazzole art. 479.00 sfuse	<input type="checkbox"/>	479019
479.10	ø 38 mm	<input checked="" type="checkbox"/>	479101

SPAZZOLA A TAZZA in filo d'acciaio - gambo ø 6 mm

480.00	ø 50 mm	10	480008
480.01	20 spazzole art. 480.00 sfuse	1	480015
485.00	ø 70 mm	10	485003
485.01	20 spazzole art. 485.00 sfuse	1	485010
485.20	ø 85 mm	10	485201
485.21	20 spazzole art. 485.20 sfuse	1	485218

**SPAZZOLA A TAZZA** in filo d'acciaio - foro M14

485.30	ø 60 mm	10	485300
485.31	20 spazzole art. 485.30 sfuse	1	485317
485.40	ø 85 mm	10	485409
485.41	20 spazzole art. 485.40 sfuse	1	485416
485.50	ø 100 mm	5	485508
485.51	10 spazzole art. 485.50 sfuse	1	485515
485.60	ø 120 mm	5	485607
485.61	5 spazzole art. 485.60 sfuse	1	485614
485.65	ø 150 mm	5	485652
485.70	ø 75 mm - a mazzetti ritorti	5	485706
485.75	ø 85 mm - a mazzetti ritorti	5	485751
485.76	ø 100 mm - a mazzetti ritorti	1	485768
485.77	ø 120 mm - a mazzetti ritorti	1	485775



SPAZZOLA CIRCOLARE in nylon abrasivo - gambo ø 6 mm



497.05	ø 75 mm - arancio grana 80	5	497051
497.10	ø 75 mm - blu grana 150	5	497105
497.15	ø 100 mm - arancio grana 80	5	497150
497.20	ø 100 mm - blu grana 150	5	497204

SPAZZOLA A TAZZA in nylon abrasivo - gambo ø 6 mm

497.25	ø 50 mm - arancio grana 80	5	497259
497.30	ø 50 mm - blu grana 150	5	497303
497.35	ø 70 mm - arancio grana 80	5	497358
497.40	ø 70 mm - blu grana 150	5	497402

SPAZZOLA A PENNELLO in nylon abrasivo - gambo ø 6 mm

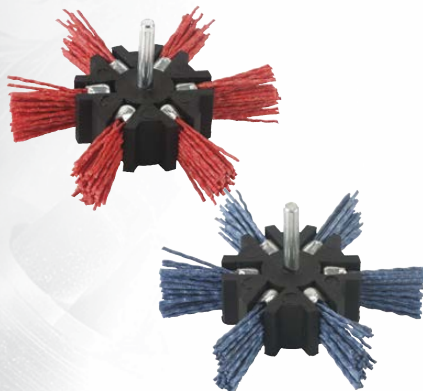
497.45	ø 25 mm - arancio grana 80	5	497457
497.50	ø 25 mm - blu grana 150	5	497501

SPAZZOLA A VENTAGLIO in nylon abrasivo - gambo ø 6 mm

497.55	ø 100 mm - arancio grana 80	5	497556
497.60	ø 100 mm - blu grana 150	5	497600



ASSORTIMENTO SPAZZOLE ACCIAIO in espositore self-service

496.00	40 spazzole filo d'acciaio:	1	496009
	10 art. 469.00 - 10 art. 470.00		
	10 art. 480.00 - 10 art. 485.00		



ASSORTIMENTO SPAZZOLE NYLON in espositore self-service

496.50	30 spazzole in nylon abrasivo:	1	496504
	3 spazzole per tipo art. 497.05 - 10 - 15 - 20 - 25 -		
	30 - 35 - 40 - 45 - 50		



ASSORTIMENTO SPAZZOLE A MANO in espositore self-service

496.90	24 spazzole a mano:	1	496900
	8 spazzole per tipo art. 496.93 - 496.96 - 496.99		





SPAZZOLA A MANO in espositore self-service

497.00 filo d'acciaio

24

497006



SPAZZOLA A MANO in espositore self-service

496.99 filo d'acciaio inox

24

496993



SPAZZOLA A MANO in espositore self-service

496.96 filo di ottone

24

496962



SPAZZOLA A MANO in espositore self-service

496.93 filo di nylon abrasivo

24

496931



MINI SPAZZOLA A MANO

496.82 filo d'acciaio

12

496825



MINI SPAZZOLA A MANO

496.84 filo d'acciaio inox

12

496849



MINI SPAZZOLA A MANO

496.85 filo di ottone

12

496856



MINI SPAZZOLA A MANO

496.88 filo di nylon

12

496887





KIT 5 SPAZZOLE in filo d'acciaio

497.02	spazzola circolare ø 50 mm + spazzola circolare ø 75 mm + spazzola a tazza ø 50 mm + spazzola a tazza ø 70 mm + spazzola a pennello ø 16 mm	3	497020
---------------	--	----------	--------



KIT 4 SPAZZOLE in filo d'acciaio

497.04	spazzola circolare ø 75 mm + spazzola a tazza ø 50 mm + spazzola a pennello ø 25 mm + spazzola a mano	10	497044
---------------	--	-----------	--------



Totale referenze 15		Totale pezzi 134		
Professional				
10x 476.00	10x 469.00	10x 477.00	10x 478.00	10x 479.00
10x 470.00	10x 475.00	10x 480.00		
10x 485.00	10x 485.20	10x 485.40		
7x 485.30		7x 485.70		
5x 485.50		5x 485.75		

ESPOSITORE DA BANCO

ESPO.S1	- altezza 80 cm	1	087450
	- larghezza 37 cm		
	- profondità 32 cm		



Totale referenze 8		Totale pezzi 94	
Professional			
10x 478.00	10x 479.00	10x 470.00	
10x 475.00	10x 485.00		
10x 485.20	10x 485.40		
24x 497.00			

ESPOSITORE DA BANCO

ESPO.S2	- altezza 70 cm	1	087702
	- larghezza 28 cm		
	- profondità 34 cm		

OCCHIALI DI PROTEZIONE

498.00	per saldatura - CE - EN 166	5	498003
498.50	per saldatura - doppia lente - CE - EN 166	5	498508
498.60	per saldatura - professionali - doppia lente - CE - EN 166	1	498607

OCCHIALI DI PROTEZIONE

500.00	professionali - con ripari laterali - CE - EN 166	1	500003
500.25	professionali - sovrapponibili agli occhiali da vista - con ripari laterali - CE - EN 166	1	500256
500.35	professionali - con ripari laterali - CE - EN 166	1	500355

OCCHIALI DI PROTEZIONE

501.00	tipo morbido - modello hobby - non DPI	5	501000
501.20	tipo morbido - con microfori - CE - EN 166	1	501208
501.40	tipo morbido - con valvole di aerazione - CE - EN 166	1	501406
501.60	tipo morbido - professionali - con valvole di aerazione maggiore protezione - CE - EN 166	1	501604

MASCHERA PROTETTIVA ANTIPOLVERE

502.00	5 maschere - non DPI	10	502007
502.50	50 maschere - non DPI	1	502502
502.60	2 maschere contro polveri non tossiche - CE - EN 149 FFP1	10	502601
502.70	2 maschere a carboni attivi con valvola di espirazione, contro polveri non tossiche, odori e polveri organiche - CE - EN 149 FFP1	5	502700
503.00	1 maschera rinforzata - non DPI	10	503004

**RESPIRATORE E FILTRI DI RICAMBIO**

504.00	respiratore con filtro antipolvere - non DPI	5	504001
504.20	filtro antipolvere - non DPI	5	504209
504.40	filtro chimico - non DPI	5	504407

**RESPIRATORE E FILTRI DI RICAMBIO**

504.50	respiratore con filtro per vapori organici, vernici e solventi A1 - CE - EN 140/141	1	504506
504.55	filtro per vapori organici, vernici e solventi A1 - CE - EN 140/141	2	504551
504.58	filtro per polveri fini e aerosol P3 - CE - EN 140/143	2	504582



RESPIRATORE CON 2 FILTRI E FILTRI DI RICAMBIO

504.70	respiratore con 2 filtri per vapori organici, vernici e solventi A1 - CE - EN 140/141	1	504704
504.75	filtro per vapori organici, vernici e solventi A1 - CE - EN 140/141	2	504759
504.78	filtro per polveri fini e aerosol P3 - CE - EN 140/143	2	504780

CUFFIA ANTIRUMORE

505.00	modello hobby - non DPI	5	505008
505.20	livello di attenuazione medio - alto - CE - EN 352-1	1	505206
505.40	livello di attenuazione alto - professionale - CE - EN 352-1	1	505404

KIT ANTI-INFORTUNISTICA - CE

505.50	occhiali di protezione EN166 + maschera antipolvere EN149 + tappi auricolari EN352-2 + cuffia antirumore EN352-1	1	505503
---------------	--	----------	--------

TAPPI AURICOLARI

505.80	3 paia in schiuma poliuretana - CE - EN 352-3	10	505800
505.83	5 paia in bimatereale - alto comfort - CE - EN 352-3	10	505831
505.86	1 paio a tripla flangia con cordoncino - CE - EN 352-2	10	505862



GUANTI IN NITRILE SPESSORATI

Uso professionale - **CE** - EN388 - EN455 1 & 2

506.10	Taglia M	50 guanti monouso: - ipoallergenici - non contengono lattice	1	506104
506.11	Taglia L	- con polveri vegetali antisudore - bordo rinforzato	1	506111
506.12	Taglia XL	- ambidestri - polso lungo	1	506128



GUANTI IN NITRILE

Uso professionale - **CE** - EN455 1 & 2

506.15	Taglia M	100 guanti monouso: - ipoallergenici - non contengono lattice	1	506159
506.16	Taglia L	- con polveri vegetali antisudore - bordo rinforzato	1	506166
506.17	Taglia XL	- ambidestri	1	506173

GINOCCHIERE IN GOMMA

506.50	ginocchiere in gomma	1	506500
---------------	----------------------	---	--------



ELMETTO DI PROTEZIONE

506.60	elmetto protettivo - CE - EN 397	1	506609
---------------	---	---	--------



MISCELATORE

Per malta, cemento, intonaco, vernici, colle e altri liquidi

507.00	Ø 80 x 400 mm - gambo ch. 8	5	507002
508.00	Ø 100 x 500 mm - gambo ch. 8	2	508009
509.00	Ø 120 x 600 mm - gambo ch. 10	2	509006

MISCELATORE

Per malta, cemento, intonaco, vernici, colle e altri liquidi

509.40	Ø 130 x 600 mm - gambo ch. 10	2	509402
---------------	-------------------------------	---	--------

MISCELATORE

Per vernici, colori, smalti, colle e altri liquidi

510.00	Ø 60 x 350 mm - gambo Ø 6 mm	10	510002
511.00	Ø 60 x 400 mm - gambo ch. 8	5	511009
512.00	Ø 80 x 400 mm - gambo ch. 8	5	512006
513.00	Ø 100 x 600 mm - gambo ch. 10	2	513003
514.00	Ø 120 x 600 mm - gambo ch. 12	2	514000
514.10	Ø 125 x 600 mm - gambo ch. 10 - doppia elica	2	514109

COLTELLO PROFESSIONALE

566.00	per antinfortunistica, con rientro automatico della lama a fine lavoro	4	566009
566.05	permette di effettuare il cambio della lama senza l'uso di utensili - con 5 lame incluse	4	566054
566.11	sistema automatico di ricarica della lama - regolazione della lama in 3 posizioni - con 5 lame incluse	2	566115



CUTTER PROFESSIONALE

Con lama retraibile a spezzare, regolabile e trancialama nel manico

566.12	lama 25 mm - con guida in metallo ed impugnatura in gomma	12	566122
566.14	lama 9 mm - con guida in metallo ed impugnatura in gomma - con 3 lame incluse	24	566146
566.16	lama 18 mm - con guida in metallo ed impugnatura in gomma - con 3 lame incluse	24	566160



CUTTER - In espositore self-service

Con meccanismo autobloccante della lama, vano portalama nel manico, sistema di ricarica automatica della lama

566.17	lama 9 mm - con guida in metallo e corpo in bimateriale - con 3 lame incluse	12	566177
566.18	lama 18 mm - con guida in metallo e corpo in bimateriale - con 3 lame incluse	12	566184



CUTTER

Con lama retraibile a spezzare, regolabile e trancialama nel manico

566.20	lama 9 mm - corpo in metallo	24	566207
566.23	lama 9 mm - corpo in ABS	24	566238
566.25	lama 9 mm - con guida in metallo	24	566252



CUTTER

Con lama retraibile a spezzare, regolabile e trancialama nel manico

**566.30** lama **9** mm - corpo in ABS trasparente 24 566306**566.40** lama **18** mm - corpo in ABS trasparente 24 566405**566.50** lama **18** mm - con guida in metallo 24 566504**566.60** lama **18** mm - con guida in metallo 24 566603**RASCHIETTO****567.00** raschietto con lama retraibile 24 567006**LAME DI RICAMBIO****568.00** **5** lame a trapezio piccole 12 568003**568.10** **5** lame a trapezio grandi 12 568102**568.20** **5** lame ad uncino 12 568201**568.30** **10** lame a spezzare **9** mm 12 568300**568.40** **10** lame a spezzare **18** mm 12 568409**568.50** **5** lame a spezzare **25** mm 12 568508**TAGLIAVETRO****569.00** con rotella in metallo duro 5 569000

SGORBIE con impugnatura in legno per falegname

570.00	5 sgorbie assortite	<input checked="" type="checkbox"/>	2	570006
572.00	6 sgorbie assortite	<input checked="" type="checkbox"/>	2	572000

**SCALPELLO** con impugnatura in legno per falegname

575.00	6 mm	<input checked="" type="checkbox"/>	5	575001
576.00	8 mm	<input checked="" type="checkbox"/>	5	576008
577.00	10 mm	<input checked="" type="checkbox"/>	5	577005
578.00	12 mm	<input checked="" type="checkbox"/>	5	578002
579.00	14 mm	<input checked="" type="checkbox"/>	5	579009
580.00	16 mm	<input checked="" type="checkbox"/>	5	580005
581.00	18 mm	<input checked="" type="checkbox"/>	5	581002
582.00	20 mm	<input checked="" type="checkbox"/>	5	582009
583.00	26 mm	<input checked="" type="checkbox"/>	5	583006
584.00	30 mm	<input checked="" type="checkbox"/>	5	584003
585.00	32 mm	<input checked="" type="checkbox"/>	5	585000
586.00	40 mm	<input checked="" type="checkbox"/>	5	586007

**TRIVELLINO** per legno

590.00	∅ 2 mm	<input checked="" type="checkbox"/>	10	590004
591.00	∅ 3 mm	<input checked="" type="checkbox"/>	10	591001
592.00	∅ 4 mm	<input checked="" type="checkbox"/>	10	592008
593.00	∅ 5 mm	<input checked="" type="checkbox"/>	10	593005
594.00	∅ 6 mm	<input checked="" type="checkbox"/>	10	594002
595.00	∅ 8 mm	<input checked="" type="checkbox"/>	10	595009
597.00	3 trivellini ∅ 2 - 3 - 4 mm	<input checked="" type="checkbox"/>	10	597003



LEVA CHIODI

598.00	190 mm	<input checked="" type="checkbox"/>	598000
---------------	---------------	-------------------------------------	--------

PIALLA E SPONDERUOLA IN LEGNO

Con lama in acciaio - piana per rifinitura



624.00	36 mm	<input checked="" type="checkbox"/>	624006
625.00	45 mm - doppia lama	<input checked="" type="checkbox"/>	625003
626.00	48 mm - doppia lama	<input checked="" type="checkbox"/>	626000
628.00	24 mm	<input checked="" type="checkbox"/>	628004
629.00	27 mm	<input checked="" type="checkbox"/>	629001

LAMA IN ACCIAIO

624.10	36 mm - per art. 624.00	<input checked="" type="checkbox"/>	624105
625.10	45 mm - per art. 625.00	<input checked="" type="checkbox"/>	625102
626.10	48 mm - per art. 626.00	<input checked="" type="checkbox"/>	626109
628.10	24 mm - per art. 628.00	<input checked="" type="checkbox"/>	628103
629.10	27 mm - per art. 629.00	<input checked="" type="checkbox"/>	629100

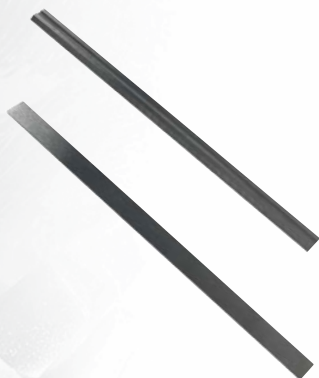
LAME REVERSIBILI IN METALLO DURO PER PIALLETTI ELETTRICI

codice	caratteristiche	utilizzabili su:	q.tà	EAN13 8011017
629.85	2 lame 75,5 x 5,5 x 1,1 mm	AEG - B&D - Bosch - Festo - Haffner - Holz Her - Kress - Mafell - Metabo - Scheer - Skil	<input checked="" type="checkbox"/>	629858
629.87	2 lame 80,5 x 5,9 x 1,1 mm	Elu - B&D	<input checked="" type="checkbox"/>	629872
629.89	2 lame 82,0 x 5,5 x 1,1 mm	AEG - B&D - Bosch - Fein - Felisatti - Festo - Haffner - Hitachi - Holz Her - Mafell - Makita - Metabo - Skil	<input checked="" type="checkbox"/>	629896
629.93	2 lame 102,0 x 5,5 x 1,1 mm	AEG	<input checked="" type="checkbox"/>	629933

GRAFFATRICE

601.00	modello hobby per punti 4 - 6 - 8 mm	<input checked="" type="checkbox"/>	601007
604.00	con corpo in metallo e regolatore di pressione per punti da 4 a 14 mm	<input checked="" type="checkbox"/>	604008



PUNTI PER GRAFFATRICE

607.30	5000 punti 6 mm	<input type="checkbox"/>	607306
607.35	1000 punti 6 mm	<input checked="" type="checkbox"/>	607351
607.40	5000 punti 8 mm	<input type="checkbox"/>	607405
607.45	1000 punti 8 mm	<input checked="" type="checkbox"/>	607450
607.50	5000 punti 10 mm	<input type="checkbox"/>	607504
607.55	1000 punti 10 mm	<input checked="" type="checkbox"/>	607559
607.60	5000 punti 12 mm	<input type="checkbox"/>	607603
607.65	1000 punti 12 mm	<input checked="" type="checkbox"/>	607658
607.70	5000 punti 14 mm	<input type="checkbox"/>	607702
607.75	1000 punti 14 mm	<input checked="" type="checkbox"/>	607757

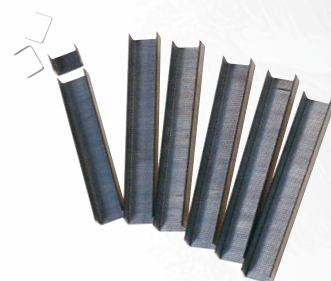

FLESSOMETRO

Nastro in metallo plastificato, corpo in ABS anti-urto, rientro automatico e clip per cintura, con doppio dispositivo di bloccaggio



611.10	3 m - nastro 16 mm - CE	<input type="checkbox"/>	12	611105
611.20	5 m - nastro 19 mm - CE	<input type="checkbox"/>	6	611204
611.30	8 m - nastro 25 mm - CE	<input type="checkbox"/>	4	611303

**ESPOSITORE FLESSOMETRI**

611.25	12 flessometri 5 m art. 611.20 - CE	<input type="checkbox"/>	1	611259
---------------	--	--------------------------	---	--------

MATITA DA FALEGNAME

649.00	180 mm	144	009407
649.06	6 matite 180 mm	5	649061



MORSETTO PER SPINATURA

650.00	completo di tasselli in legno \varnothing 6 - 8 - 10 mm e 3 spaziatori	1	650005
--------	--	---	--------



TASSELLI DI LEGNO

655.00	100 tasselli \varnothing 6 x 30 mm	10	655000
655.05	1000 tasselli \varnothing 6 x 30 mm	1	655055
660.00	60 tasselli \varnothing 8 x 35 mm	10	660004
660.05	1000 tasselli \varnothing 8 x 35 mm	1	660059
665.00	40 tasselli \varnothing 10 x 40 mm	10	665009
665.05	1000 tasselli \varnothing 10 x 40 mm	1	665054
666.00	30 tasselli \varnothing 12 x 40 mm	10	666006
666.05	500 tasselli \varnothing 12 x 40 mm	1	666051



TASSELLI DI LEGNO IN ASTE

668.00	100 aste \varnothing 6 x 1000 mm	1	668000
668.10	100 aste \varnothing 8 x 1000 mm	1	668109
668.20	100 aste \varnothing 10 x 1000 mm	1	668208
668.30	50 aste \varnothing 12 x 1000 mm	1	668307
668.40	40 aste \varnothing 14 x 1000 mm	1	668406
668.50	40 aste \varnothing 16 x 1000 mm	1	668505



LAMELLE DI LEGNO

669.00	50 lamelle tipo 0 - 48 x 16 x 4 mm	<input checked="" type="checkbox"/>	669007
669.05	1000 lamelle tipo 0 - 48 x 16 x 4 mm	<input type="checkbox"/>	669052
669.10	50 lamelle tipo 10 - 53 x 19 x 4 mm	<input checked="" type="checkbox"/>	669106
669.15	1000 lamelle tipo 10 - 53 x 19 x 4 mm	<input type="checkbox"/>	669151
669.20	50 lamelle tipo 20 - 61 x 24 x 4 mm	<input checked="" type="checkbox"/>	669205
669.25	1000 lamelle tipo 20 - 61 x 24 x 4 mm	<input type="checkbox"/>	669250

BOCCOLE DI ARRESTO

620.00	3 boccole \varnothing 6 - 8 - 10 mm	<input checked="" type="checkbox"/>	620008
620.10	1 boccola \varnothing 12 mm	<input checked="" type="checkbox"/>	620107
620.20	1 boccola \varnothing 14 mm	<input checked="" type="checkbox"/>	620206

SPINE A CENTRARE

670.00	4 spine \varnothing 6 mm	<input checked="" type="checkbox"/>	670003
675.00	4 spine \varnothing 8 mm	<input checked="" type="checkbox"/>	675008
680.00	4 spine \varnothing 10 mm	<input checked="" type="checkbox"/>	680002
680.10	4 spine \varnothing 12 mm	<input checked="" type="checkbox"/>	680101
680.20	2 spine \varnothing 14 mm	<input checked="" type="checkbox"/>	680200

KIT DI ASSEMBLAGGIO

681.00	con punta per trapano \varnothing 6 mm - boccola di arresto 4 spine a centrare - 25 tasselli di legno	<input checked="" type="checkbox"/>	681009
682.00	con punta per trapano \varnothing 8 mm - boccola di arresto 4 spine a centrare - 25 tasselli di legno	<input checked="" type="checkbox"/>	682006
683.00	con punta per trapano \varnothing 10 mm - boccola di arresto 4 spine a centrare - 20 tasselli di legno	<input checked="" type="checkbox"/>	683003

codice

caratteristiche

q.tà
imballoEAN13
8011017**LAME PER
SEGHETTI
ALTERNATIVI****LAME PER SEGHETTI ALTERNATIVI - ATTACCO BLACK & DECKER****HSS - per metallo**

684.00	3 lame - denti grossi	10	684000
685.00	3 lame - denti medi	10	685007
686.00	3 lame - denti fini	10	686004
686.50	3 lame - denti medi - lunghezza 80 mm	10	686509

**CV - per laminati e legno**

687.00	3 lame - denti grossi	10	687001
688.00	3 lame - denti medi	10	688008
689.00	3 lame - denti fini	10	689005
689.10	3 lame - denti grossi - con lama rettificata	10	689104
689.20	3 lame - denti medi - con lama rettificata	10	689203
689.50	3 lame - denti medi - lunghezza 100 mm	10	689500
720.00	3 lame - denti medi - per tagli sagomati	10	720005
720.50	2 lame - a doppia dentatura - lunghezza 115 mm - per tagli curvi estremi privi di sbavature	5	720500

**METALLO DURO - per vetro, ceramica e laterizi**

724.00	1 lama	5	724003
---------------	---------------	---	--------

**KIT 10 LAME PER SEGHETTI ALTERNATIVI - ATTACCO BLACK & DECKER**

720.90	3 lame CV denti grossi per legno + 3 lame CV denti medi per legno + 2 lame CV tagli curvi per legno + 2 lame HSS denti fini per metallo	3	720906
---------------	---	---	--------

 imballo PG

 imballo neutro

**LAME PER SEGHETTI ALTERNATIVI - ATTACCO BOSCH LARGO
HSS - per metallo**

694.00	3 lame - denti grossi	10	694009
695.00	3 lame - denti medi	10	695006
696.00	3 lame - denti fini	10	696003
696.50	3 lame - denti medi - lunghezza 80 mm	10	696508

CV - per laminati e legno

697.00	3 lame - denti grossi	10	697000
698.00	3 lame - denti medi	10	698007
699.00	3 lame - denti fini	10	699004
699.10	3 lame - denti grossi - con lama rettificata	10	699103
699.20	3 lame - denti medi - con lama rettificata	10	699202
699.50	3 lame - denti medi - lunghezza 100 mm	10	699509
699.60	2 lame - denti medi - lunghezza 220 mm - per materiali isolanti e styropor	10	087399
721.00	3 lame - denti medi - per tagli sagomati	10	721002
721.50	2 lame - a doppia dentatura - lunghezza 115 mm - per tagli curvi estremi privi di sbavature	5	721507

METALLO DURO - per vetro, ceramica e laterizi

725.00	1 lama	5	725000
---------------	---------------	----------	--------

KIT 10 LAME PER SEGHETTI ALTERNATIVI - ATTACCO BOSCH LARGO

721.90	3 lame CV denti grossi per legno + 3 lame CV denti medi per legno + 2 lame CV tagli curvi per legno + 2 lame HSS denti fini per metallo	3	721903
---------------	---	----------	--------

LAME PER SEGHETTI ALTERNATIVI - ATTACCO MAKITA**HSS** - per metallo

714.00	3 lame - denti grossi	10	714004
715.00	3 lame - denti medi	10	715001
716.00	3 lame - denti fini	10	716008

HSS HIGH SPEED STEEL**CV** - per laminati e legno

717.00	3 lame - denti grossi	10	717005
718.00	3 lame - denti medi	10	718002
719.00	3 lame - denti fini	10	719009
722.00	3 lame - denti medi - per tagli sagomati	10	722009

CV CHROME VANADIUM**CV** CHROME VANADIUM**LAME PER SEGHETTI ALTERNATIVI - ATTACCO BOSCH STRETTO****HSS** - per metallo

704.00	3 lame - denti grossi	10	704005
705.00	3 lame - denti medi	10	705002
706.00	3 lame - denti fini	10	706009

HSS HIGH SPEED STEEL**CV** - per laminati e legno

707.00	3 lame - denti grossi	10	707006
708.00	3 lame - denti medi	10	708003

CV CHROME VANADIUM

imballo PG



imballo neutro

SEGA A TAZZA

Per legno, cartongesso e materie sintetiche



730.00	con 7 lame da \varnothing 25 mm a \varnothing 62 mm altezza 25 mm	<input type="checkbox"/>	10	730004
732.00	con 7 lame da \varnothing 25 mm a \varnothing 62 mm altezza 50 mm	<input type="checkbox"/>	10	732008
735.00	con 5 lame da \varnothing 60 mm a \varnothing 95 mm altezza 40 mm	<input type="checkbox"/>	5	735009

TAGLIAPIASTRELLE CIRCOLARE

Con punta centrante e tagliente in metallo duro

217.00	per forare da \varnothing 30 mm a \varnothing 100 mm - 450 RPM	<input type="checkbox"/>	1	217000
217.10	utensile di ricambio per art. 217.00	<input type="checkbox"/>	1	217109

ALBERO PER SEGA A TAZZA BIMETAL

13.780	\varnothing 14/30 mm - gambo \varnothing 6,35 mm	<input type="checkbox"/>	1	137803
13.785	\varnothing 32/152 mm - gambo \varnothing 6,35 mm	<input type="checkbox"/>	1	137858
13.790	\varnothing 14/30 mm - gambo ch. 12 mm	<input type="checkbox"/>	1	137902
13.795	\varnothing 32/152 mm - gambo ch. 12 mm	<input type="checkbox"/>	1	137957

PUNTA DI RICAMBIO PER ALBERO BIMETAL

13.800	lunghezza 115 mm	<input type="checkbox"/>	1	138008
13.805	lunghezza 70 mm	<input type="checkbox"/>	1	138053

SEGA A TAZZA BIMETAL

13.500	Ø 14 mm	1	135007
13.505	Ø 16 mm	1	135052
13.510	Ø 17 mm	1	135106
13.515	Ø 19 mm	1	135151
13.520	Ø 20 mm	1	135205
13.525	Ø 21 mm	1	135250
13.530	Ø 22 mm	1	135304
13.535	Ø 24 mm	1	135359
13.540	Ø 25 mm	1	135403
13.545	Ø 27 mm	1	135458
13.550	Ø 29 mm	1	135502
13.555	Ø 30 mm	1	135557
13.560	Ø 32 mm	1	135601
13.565	Ø 33 mm	1	135656
13.570	Ø 35 mm	1	135700
13.575	Ø 37 mm	1	135755
13.580	Ø 38 mm	1	135809
13.585	Ø 40 mm	1	135854
13.590	Ø 41 mm	1	135908
13.595	Ø 43 mm	1	135953
13.600	Ø 44 mm	1	136004
13.605	Ø 46 mm	1	136059
13.610	Ø 48 mm	1	136103
13.615	Ø 51 mm	1	136158
13.620	Ø 52 mm	1	136202
13.625	Ø 54 mm	1	136257
13.630	Ø 57 mm	1	136301
13.635	Ø 59 mm	1	136356
13.640	Ø 60 mm	1	136400
13.645	Ø 64 mm	1	136455
13.650	Ø 65 mm	1	136509
13.655	Ø 67 mm	1	136554
13.660	Ø 70 mm	1	136608
13.665	Ø 73 mm	1	136653
13.670	Ø 76 mm	1	136707
13.675	Ø 79 mm	1	136752
13.680	Ø 83 mm	1	136806
13.685	Ø 86 mm	1	136851
13.690	Ø 89 mm	1	136905
13.695	Ø 92 mm	1	136950
13.700	Ø 95 mm	1	137001
13.705	Ø 98 mm	1	137056
13.710	Ø 102 mm	1	137100
13.715	Ø 105 mm	1	137155
13.720	Ø 108 mm	1	137209
13.725	Ø 111 mm	1	137254
13.730	Ø 114 mm	1	137308
13.735	Ø 121 mm	1	137353
13.740	Ø 127 mm	1	137407
13.745	Ø 140 mm	1	137452
13.750	Ø 152 mm	1	137506



imballo PG



imballo neutro

SEGA CIRCOLARE IN CV

ø mm		nr. denti	RPM	codice	q.tà	EAN13 8011017
est.	foro					
125	20	24	7000	740.00	(5)	740003
125	20	80	7000	745.00	(5)	745008
150	20	24	7000	750.00	(5)	750002
150	20	80	7000	755.00	(5)	755007

 Sono incluse **2** riduzioni per fori: **20/13** mm e **20/16** mm

**SEGA CIRCOLARE CON RIPORTO IN METALLO DURO
DENTATURA ALTERNATA**

ø mm		nr. denti	utilizzabili su:	RPM	codice	q.tà	EAN13 8011017
est.	foro						
125	20	18	Bosch - Festo - Haffner - Hitachi - Mafell - Metabo - Ulmia	13000	756.02	(1)	756028
140	20	18	AEG - Bosch - Peugeot - Holz Her - Makita - Metabo - Stayer	13000	756.06	(1)	756066
150	20	20	AEG - B&D - Bosch - Elu - Fein - Hitachi - Kress - Mafell - Metabo - Peugeot - Scheer - Skil - Wegoma	13000	756.10	(1)	756103
150	30	36		13000	756.12	(1)	756127
160	20	24	AEG - B&D - Bosch - Einhell - Fein - Festo - Haffner - Hitachi - Holz Her - Kress - Mafell - Makita - Narex - Peugeot - Protool - Rockwell - Ryobi - Scheer - Skil - Ulmia	9500	756.14	(1)	756141
160	20	36		9500	756.16	(1)	756165
170	30	18	Bosch - Elu - Festo - Haffner - Hitachi - Holz Her - Mafell - Makita - Metabo - Skil	9500	756.18	(1)	756189
170	30	36		9500	756.20	(1)	756202
180	30	22	B&D - Bosch - Elu - Festo - Haffner - Hitachi - Holz Her - Mafell - Makita - Metabo - Peugeot - Ryobi - Skil	9500	756.22	(1)	756226
180	30	36		9500	756.24	(1)	756240
180	30	52		9500	756.26	(1)	756264
190	30	30	AEG - B&D - Bosch - DeWalt - Elu - Festo - Hitachi - Holz Her - Kress - Mafell - Makita - Metabo - Protool - Scheer - Skil - Stayer	9500	756.28	(1)	756288
190	30	42		9500	756.30	(1)	756301
200	30	42	AEG - B&D - Bosch - Festo - Haffner - Hanning - Holz Her - Kity - Mafell - Makita - Ryobi - Scheer - Ulmia	9500	756.32	(1)	756325
200	30	60		9500	756.34	(1)	756349
210	30	20	AEG - B&D - Bosch - Elektra Beckum - Elu - Fein - Haffner - Hitachi - Holz Her - Mafell - Makita - Metabo - Skil - Stayer	9500	756.36	(1)	756363
210	30	30		9500	756.38	(1)	756387
210	30	42		9500	756.40	(1)	756400
230	30	20	AEG - B&D - Bosch - Festo - Haffner - Holz Her - Mafell - Peugeot - Scheer - Skil - Stayer	9500	756.42	(1)	756424
230	30	34		9500	756.44	(1)	756448
230	30	40		9500	756.46	(1)	756462
250	30	24	Elektra Beckum - Elu - Mafell - Metabo	8000	756.48	(1)	756486
250	30	48		8000	756.50	(1)	756509
250	30	60		8000	756.52	(1)	756523
300	30	48	Elektra Beckum - Elu	4000	756.54	(1)	756547
300	30	72		4000	756.56	(1)	756561
300	30	96		4000	756.58	(1)	756585
350	30	84	Festo	4000	756.60	(1)	756608
350	30	108		4000	756.62	(1)	756622

MANDRINO AUTOSERRANTE

Attacco maschio

760.00	3/8" x 24 - serraggio fino \varnothing 10 mm per Black & Decker	1	760001
---------------	--	---	--------

**MANDRINO AUTOSERRANTE**

Attacco femmina

762.00	3/8" x 24 - serraggio fino \varnothing 10 mm per Skil, Metabo, Makita, Wolf	1	762005
764.00	3/8" x 24 - serraggio fino \varnothing 13 mm per Skil, Metabo, Makita, Wolf	1	764009
766.00	1/2" x 20 - serraggio fino \varnothing 10 mm per Atlas Copco, Bosch, Fein, Kress, Metabo	1	766003
768.00	1/2" x 20 - serraggio fino \varnothing 13 mm per Atlas Copco, Bosch, Fein, Kress, Metabo	1	768007

**MANDRINO SENZA CHIAVE** per utensili reversibili

Attacco maschio

773.00	3/8" x 24 - serraggio fino \varnothing 10 mm per Black & Decker	1	773001
---------------	--	---	--------

**MANDRINO SENZA CHIAVE** per utensili reversibili

Attacco femmina

774.00	3/8" x 24 - serraggio fino \varnothing 10 mm per Skil, Metabo, Makita, Wolf	1	774008
774.50	3/8" x 24 - serraggio fino \varnothing 13 mm per Skil, Metabo, Makita, Wolf	1	774503
775.00	1/2" x 20 - serraggio fino \varnothing 10 mm per Atlas Copco, Bosch, Fein, Kress, Metabo	1	775005
775.50	1/2" x 20 - serraggio fino \varnothing 13 mm - corpo in metallo - UTILIZZABILE ANCHE SU TRAPANI A PERCUSSIONE per Atlas Copco, Bosch, Fein, Kress, Metabo	1	775500
775.60	1/2" x 20 - serraggio fino \varnothing 13 mm per Atlas Copco, Bosch, Fein, Kress, Metabo	1	775609

**MANDRINO SENZA CHIAVE**

Attacco SDS PLUS

775.51	serraggio fino \varnothing 13 mm - corpo in metallo - UTILIZZABILE ANCHE SU TRAPANI A PERCUSSIONE	1	775517
775.61	serraggio fino \varnothing 13 mm	1	775616



imballo PG



imballo neutro

MANDRINO A CREMAGLIERA

Attacco maschio



780.00	3/8" x 24 - serraggio fino \varnothing 10 mm per Black & Decker	1	780009
781.00	3/8" x 24 - serraggio fino \varnothing 13 mm per Black & Decker	1	781006

MANDRINO A CREMAGLIERA

Attacco femmina



783.00	3/8" x 24 - serraggio fino \varnothing 10 mm per Skil, Metabo, Makita, Wolf (38 mm)	1	783000
784.00	3/8" x 24 - serraggio fino \varnothing 13 mm per Skil, Metabo, Makita, Wolf (38 mm)	1	784007
786.00	1/2" x 20 - serraggio fino \varnothing 10 mm per Atlas Copco, Bosch, Fein, Kress, Metabo (43 mm)	1	786001
787.00	1/2" x 20 - serraggio fino \varnothing 13 mm per Atlas Copco, Bosch, Fein, Kress, Metabo (43 mm)	1	787008

MANDRINO A CREMAGLIERA

Attacco SDS PLUS



787.01	serraggio fino \varnothing 13 mm	1	787015
---------------	---	---	--------

MANDRINO A CREMAGLIERA

Attacco esagonale



788.00	serraggio fino \varnothing 10 mm	1	788005
---------------	---	---	--------

MANDRINO PER SVITA-AVVITA

Attacco esagonale



788.50	serraggio \varnothing 0,5-6,5 mm	5	788500
---------------	---	---	--------

RACCORDO PER MANDRINO

789.00	attacco SDS PLUS 1/2" x 20	5	789002
789.10	vite M6 sinistra per mandrini	1	789101
789.50	maschio 3/8" - maschio 1/2"	1	789507
789.60	maschio 3/8" - maschio 3/8"	1	789606
789.70	maschio 1/2" - femmina 3/8"	1	789705



CHIAVE PER MANDRINO

790.00	10 mm - per Black & Decker	10	790008
791.00	13 mm - per Black & Decker	10	791005
792.00	13 mm - universale	10	792002
793.00	16 mm - universale	5	793009
794.00	universale	5	794006



ALBERO FLESSIBILE

550.00	lunghezza 90 cm con mandrino \varnothing 6 mm 4000 RPM - CE	1	550008
555.00	lunghezza 130 cm con mandrino \varnothing 8 mm professionale - 4000 RPM - CE	1	555003
560.00	lunghezza 130 cm con mandrino \varnothing 8 mm con cuscinetti a sfera - professionale - 8000 RPM - CE	1	560007



MANDRINO PER ALBERO FLESSIBILE

550.06	\varnothing 6 mm	1	550060
555.08	\varnothing 8 mm	1	555089



imballo PG



imballo neutro

PENNA CON PUNTA IN METALLO DURO



598.50	penna per tracciare su metallo, vetro e piastrelle	5	598505
---------------	--	----------	--------

PISTOLA TERMOCOLLANTE

Ugello con protezione termica, dispositivo antigoccia. Ad avanzamento automatico. Corpo in plastica antiurto. Per incollare carta, plastica, legno, ceramica, tessuti



599.00	20 W - con 2 stick di colla \varnothing 7 mm	1	599007
---------------	---	----------	--------

599.20	40 W - con 2 stick di colla \varnothing 11 mm	1	599205
---------------	--	----------	--------

STICK COLLA A CALDO



600.00	12 stick \varnothing 7 mm - lunghezza 100 mm	10	600000
---------------	---	-----------	--------

600.20	12 stick \varnothing 11 mm - lunghezza 100 mm	10	600208
---------------	--	-----------	--------

MOLA AD ACQUA



880.00	\varnothing 100 x 20 x 16 mm per trapani con collare \varnothing 43 mm - CE	1	880006
---------------	---	----------	--------

882.00	mola di ricambio \varnothing 100 x 20 mm - foro \varnothing 16 mm per art. 880.00	1	882000
---------------	---	----------	--------

POMPA PER LIQUIDI



890.00	gambo \varnothing 8 mm - per tubi 1/2" - 2500 l/h 3000 RPM - CE	5	890005
---------------	---	----------	--------

TRAPANO A MANO

921.00	con mandrino autoserrante ø 6 mm manico in plastica - porta punta	5	921006
924.00	con mandrino autoserrante ø 8 mm manico in plastica - porta punta	1	924007
928.00	con mandrino autoserrante ø 13 mm a due velocità - con appoggio	1	928005





MANDRINO DI RICAMBIO PER TRAPANO A MANO

930.00	ø 6 mm	1	930008
932.00	ø 8 mm	1	932002
936.00	ø 13 mm	1	936000



SET CHIAVI IN CV

946.00	8 chiavi a brugola per viti esagonali 1,5 - 2 - 2,5 - 3 - 4 - 5 - 5,5 - 6		10	946009
946.50	10 chiavi a brugola per viti esagonali 1,5 - 2 - 2,5 - 3 - 4 - 5 - 5,5 - 6 - 8 - 10		10	946504
947.00	8 chiavi per viti Torx T9 - T10 - T15 - T20 - T25 - T27 - T30 - T40		10	947006



STRETTOIO PER FALEGNAME in acciaio

948.00	apertura 150 mm	6	948003
948.10	apertura 200 mm	6	948102
948.20	apertura 250 mm	6	948201
948.30	apertura 300 mm	6	948300
948.40	apertura 400 mm	4	948409
948.50	apertura 500 mm	4	948508
948.60	apertura 600 mm	4	948607
948.65	apertura 700 mm	2	948652
948.70	apertura 800 mm	2	948706
948.80	apertura 1000 mm	2	948805
948.82	apertura 1200 mm	2	948829
948.84	apertura 1500 mm	2	948843
948.86	apertura 2000 mm	2	948867
948.88	apertura 2500 mm	2	948881
948.90	apertura 3000 mm	2	948904

STRETTOIO AUTOBLOCCANTE

948.93	apertura 150 mm	4	948935
948.95	apertura 300 mm	4	948959
948.97	apertura 450 mm	4	948973

MORSETTO DI SERRAGGIO A "C" AUTOBLOCCANTE

Con tasto di regolazione rapida

949.00	80 x 65 mm	1	949000
949.10	105 x 75 mm	1	949109
949.20	160 x 75 mm	1	949208

MORSETTO A REGOLAZIONE RAPIDA

949.50	apertura 50 mm	5	949505
949.60	apertura 75 mm	5	949604
949.70	apertura 100 mm	5	949703

**MORSETTO**

951.00	apertura 25 mm	10	951003
952.00	apertura 50 mm	10	952000
953.00	apertura 75 mm	10	953007



MORSA DA BANCO con regolazione rapida e ganasce con scanalature per il serraggio di pezzi rotondi

954.00	apertura 70 mm	1	954004
---------------	-----------------------	---	--------

**MORSETTO PER SERRAGGIO AD ANGOLO 90°**

955.00	con regolazione rapida, per l'allineamento ed il bloccaggio di parti da incollare, saldare, avvitare o inchiodare	1	955001
---------------	---	---	--------

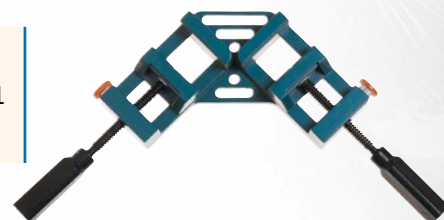
**MORSETTO AD ANGOLO** per cornici

956.00	apertura 75 mm	5	956008
---------------	-----------------------	---	--------



**MORSETTO PER SERRAGGIO A NASTRO**

Per serrare durante l'incollatura di cornici, scaffalature e mobili

957.00	lunghezza 4 m	<input type="checkbox"/>	957005
---------------	----------------------	--------------------------	--------

**MORSETTO A CRICCO**

957.50	apertura 50 mm	<input type="checkbox"/>	957500
---------------	-----------------------	--------------------------	--------

**MORSETTO A CRICCO**

957.70	apertura 70 mm	<input type="checkbox"/>	957708
---------------	-----------------------	--------------------------	--------

**MINI MORSETTI A MOLLA**

958.00	kit 4 mini morsetti - apertura 18 mm	<input type="checkbox"/>	958002
---------------	--	--------------------------	--------

MORSETTI A MOLLA

958.05	apertura 30 mm	<input type="checkbox"/>	958057
---------------	-----------------------	--------------------------	--------

958.07	apertura 40 mm	<input type="checkbox"/>	958071
---------------	-----------------------	--------------------------	--------

958.10	apertura 60 mm	<input type="checkbox"/>	958101
---------------	-----------------------	--------------------------	--------

958.14	apertura 70 mm	<input type="checkbox"/>	958149
---------------	-----------------------	--------------------------	--------



SUPPORTO ORIENTABILE per trapano

960.00	per trapani con collare \varnothing 43 mm	1	960005
---------------	--	---	--------

**TORNIO DA BANCO** per lavorare il legno

965.00	distanza regolabile per trapani con collare \varnothing 43 mm	1	965000
---------------	---	---	--------

**SUPPORTO** per fresare

970.00	per trapani con collare \varnothing 43 mm	1	970004
---------------	--	---	--------

**GUIDA REGOLABILE** per trapano

972.00	per forare e fresare in ogni angolazione 0-45° per trapani con collare \varnothing 43 mm	1	972008
---------------	---	---	--------

**SUPPORTO UNIVERSALE** per smerigliatrice angolare

Per il taglio preciso di profili e tubi in metallo. Base di lavoro con dispositivo di serraggio rapido regolabile

50.060	disco \varnothing 150/230 mm - apertura morsa 113 mm - base in ghisa 335 x 292 mm - modello professionale	1	500607
---------------	---	---	--------

50.080	disco \varnothing 150/230 mm - apertura morsa 100 mm - base in lamiera 290 x 295 mm - modello hobby	1	500805
---------------	---	---	--------

50.090	disco \varnothing 115/125 mm - apertura morsa 77 mm - base in zama 240x190 mm - modello hobby	1	500904
---------------	---	---	--------

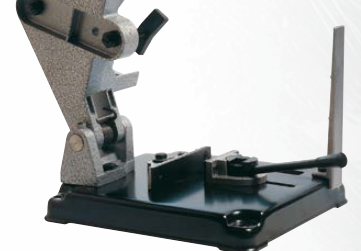

SUPPORTO UNIVERSALE per trapano

Per forare con precisione ed in sicurezza. Piano di lavoro con sistema di ancoraggio per il fissaggio di staffe di bloccaggio o morse

50.010	con collare girevole \varnothing 43 mm - altezza 440 mm - corsa 65 mm - luce (distanza albero/centro mandrino) 99,5 mm - altezza lavoro 260 mm - asta \varnothing 22 mm - molla di richiamo integrata - base in alluminio 250 x 180 mm - modello professionale	1	500102
50.020	con collare girevole \varnothing 43 mm - altezza 420 mm - corsa 60 mm - luce (distanza albero/centro mandrino) 96 mm - altezza lavoro 240 mm - asta \varnothing 22 mm - molla di richiamo integrata - base in alluminio 220 x 175 mm - modello hobby	1	500201
50.030	con collare girevole \varnothing 60 mm - dotato di 3 collari di riduzione \varnothing 43-50-53 mm - altezza 500 mm - corsa 65 mm - luce (distanza albero/centro mandrino) 95 mm - altezza lavoro 320 mm - asta \varnothing 30 mm - molla di richiamo integrata - base in alluminio 250 x 180 mm - modello professionale	1	500300
50.040	con collare girevole \varnothing 60 mm - dotato di 3 collari di riduzione \varnothing 43-50-53 mm - altezza 500 mm - corsa 65 mm - luce (distanza albero/centro mandrino) 95 mm - altezza lavoro 320 mm - asta \varnothing 30 mm - molla di richiamo integrata - base in ghisa 250 x 180 mm - modello professionale	1	500409

COLLARE DI RIDUZIONE per supporto

43.034	\varnothing 43 x 34 mm	1	430348
43.037	\varnothing 43 x 37 mm	1	430379
43.038	\varnothing 43 x 38 mm	1	430386
43.384	\varnothing 43 x 38,4 mm	1	433844
60.043	\varnothing 60 x 43 mm	1	600437
60.046	\varnothing 60 x 46 mm	1	600468
60.050	\varnothing 60 x 50 mm	1	600505
60.053	\varnothing 60 x 53 mm	1	600536
60.054	\varnothing 60 x 54 mm	1	600543
60.056	\varnothing 60 x 56 mm	1	600567

RACCOGLI - POLVERE

565.00	per punte da \varnothing 4 mm a \varnothing 10 mm	10	565002
---------------	---	----	--------

**PUNTA IN METALLO DURO per vetro e ceramica**

728.00	\varnothing 3 mm	5	728001
728.10	\varnothing 4 mm	5	728100
728.20	\varnothing 5 mm	5	728209
728.30	\varnothing 6 mm	5	728308
728.40	\varnothing 8 mm	5	728407
728.50	\varnothing 10 mm	5	728506
728.60	\varnothing 12 mm	5	728605

**PUNTA IN METALLO DURO per vetro e ceramica**

Attacco ch. 1/4"

728.80	\varnothing 3 mm	5	728803
728.81	\varnothing 4 mm	5	728810
728.82	\varnothing 5 mm	5	728827
728.83	\varnothing 6 mm	5	728834
728.85	\varnothing 8 mm	5	728858
728.87	\varnothing 10 mm	5	728872
728.89	\varnothing 12 mm	5	728896





PUNTA ELICOIDALE CILINDRICA IN ACCIAIO HSS per metallo - DIN 338
Attacco ch. 1/4"

465.02	∅ 2 mm	10	465029
465.03	∅ 3 mm	10	465036
465.04	∅ 4 mm	10	465043
465.05	∅ 5 mm	10	465050



PUNTA ELICOIDALE CILINDRICA IN ACCIAIO HSS per metallo - DIN 338

∅ mm	BLISTER PG		SFUSO		q.tà
	codice	EAN13 8011017	codice	EAN13 8011017	
1	10.010 - 2 punte	100104	17.010	170107	10
1,5	10.015 - 2 punte	100159	17.015	170152	10
2	10.020 - 2 punte	100203	17.020	170206	10
2,5	10.025 - 2 punte	100258	17.025	170251	10
3	10.030 - 2 punte	100302	17.030	170305	10
3,5	10.035 - 2 punte	100357	17.035	170350	10
4	10.040 - 2 punte	100401	17.040	170404	10
4,5	10.045	100456	17.045	170459	10
5	10.050	100500	17.050	170503	10
5,5	10.055	100555	17.055	170558	10
6	10.060	100609	17.060	170602	10
6,5	10.065	100654	17.065	170657	10
7	10.070	100708	17.070	170701	10
7,5	10.075	100753	17.075	170756	10
8	10.080	100807	17.080	170800	10
8,5	10.085	100852	17.085	170855	10
9	10.090	100906	17.090	170909	10
9,5	10.095	100951	17.095	170954	10
10	10.100	101002	17.100	171005	10
10,5	10.105	101057	17.105	171050	10
11	10.110	101101	17.110	171104	10
11,5	10.115	101156	17.115	171159	10
12	10.120	101200	17.120	171203	10
12,5	10.125	101255	17.125	171258	10
13	10.130	101309	17.130	171302	10
13,5			17.135	171357	5
14			17.140	171401	5
14,5			17.145	171456	5
15			17.150	171500	5
15,5			17.155	171555	5
16			17.160	171609	5



PUNTA ELICOIDALE FRESATA - DIN 8039 - utilizzo a rotoperussione
Per mattoni, pietra, marmo, granito e cemento

ø mm	BLISTER PG		SFUSO		q.tà
	codice	EAN13 8011017	codice	EAN13 8011017	
3	15.030	150307	16.030	160306	10
4	15.040	150406	16.040	160405	10
5	15.050	150505	16.050	160504	10
5,5			16.055	160559	10
6	15.060	150604	16.060	160603	10
6,5			16.065	160658	10
7	15.070	150703	16.070	160702	10
8	15.080	150802	16.080	160801	10
9	15.090	150901	16.090	160900	10
10	15.100	151007	16.100	161006	10
11			16.110	161105	10
12	15.120	151205	16.120	161204	10
13			16.130	161303	10
14	15.140	151403	16.140	161402	10
15			16.150	161501	10
16			16.160	161600	10
18			16.180	161808	10
20			16.200	162003	10



PUNTA ELICOIDALE FRESATA - DIN 8039 - lunghezza **400** mm

ø mm	codice	EAN13 8011017	q.tà
8	16.408	164083	1
10	16.410	164106	1
12	16.412	164120	1
14	16.414	164144	1
16	16.416	164168	1
18	16.418	164182	1
20	16.420	164205	1
22	16.422	164229	1
25	16.425	164250	1



PUNTA ELICOIDALE FRESATA - DIN 8039 - lunghezza **600** mm

ø mm	codice	EAN13 8011017	q.tà
10	16.610	166100	1
12	16.612	166124	1
14	16.614	166148	1
16	16.616	166162	1
18	16.618	166186	1
20	16.620	166209	1



imballo PG



imballo neutro

PUNTA IN CV per legno - DIN 7487



ø mm	BLISTER PG		SFUSO		q.tà
	codice	EAN13 8011017	codice	EAN13 8011017	
3	630.03	630038	14.003	140032	10
4	630.04	630045	14.004	140049	10
5	630.05	630052	14.005	140056	10
6	630.06	630069	14.006	140063	10
7	630.07	630076	14.007	140070	10
8	630.08	630083	14.008	140087	10
9	630.09	630090	14.009	140094	10
10	630.10	630106	14.010	140100	10
11	630.11	630113	14.011	140117	10
12	630.12	630120	14.012	140124	10
13	630.13	630137	14.013	140131	10
14	630.14	630144	14.014	140148	10
15			14.015	140155	10
16			14.016	140162	10
18			14.018	140186	5
20			14.020	140209	5
22			14.022	140223	5
24			14.024	140247	5
26			14.026	140261	2
28			14.028	140285	2
30			14.030	140308	2

PUNTA IN CV per legno - lunghezza 250 mm



ø mm	codice	EAN13 8011017	q.tà
6	14.206	142067	10
7	14.207	142074	10
8	14.208	142081	10
9	14.209	142098	10
10	14.210	142104	10
11	14.211	142111	10
12	14.212	142128	10
13	14.213	142135	5
14	14.214	142142	5
15	14.215	142159	5
16	14.216	142166	5
18	14.218	142180	2
20	14.220	142203	2
22	14.222	142227	2
24	14.224	142241	2

KIT DI PUNTE ASSORTITE

15.606	5 punte per LEGNO Ø 4 - 5 - 6 - 8 - 10 mm	2	156064
15.607	8 punte per LEGNO Ø 3 - 4 - 5 - 6 - 7 - 8 - 9 - 10 mm	2	156071
15.608	5 punte per MURO Ø 4 - 5 - 6 - 8 - 10 mm	2	156088
15.610	8 punte per MURO Ø 3 - 4 - 5 - 6 - 7 - 8 - 9 - 10 mm	2	156101
15.615	13 punte per METALLO Ø 1,5 - 2 - 2,5 - 3 - 3,3 - 3,5 - 4 - 4,2 - 4,5 - 5 - 5,5 - 6 - 6,5 mm	2	156156
15.620	13 punte per METALLO Ø 2 - 2,5 - 3 - 3,5 - 4 - 4,5 - 5 - 5,5 - 6 - 6,5 - 7 - 7,5 - 8 mm	2	156200
15.630	9 punte per METALLO Ø 3 - 4 - 5 - 6 - 8 mm per MURO Ø 4 - 5 - 6 - 8 mm	2	156309
15.640	9 punte per METALLO, MURO, LEGNO Ø 5 - 6 - 8 mm	2	156408



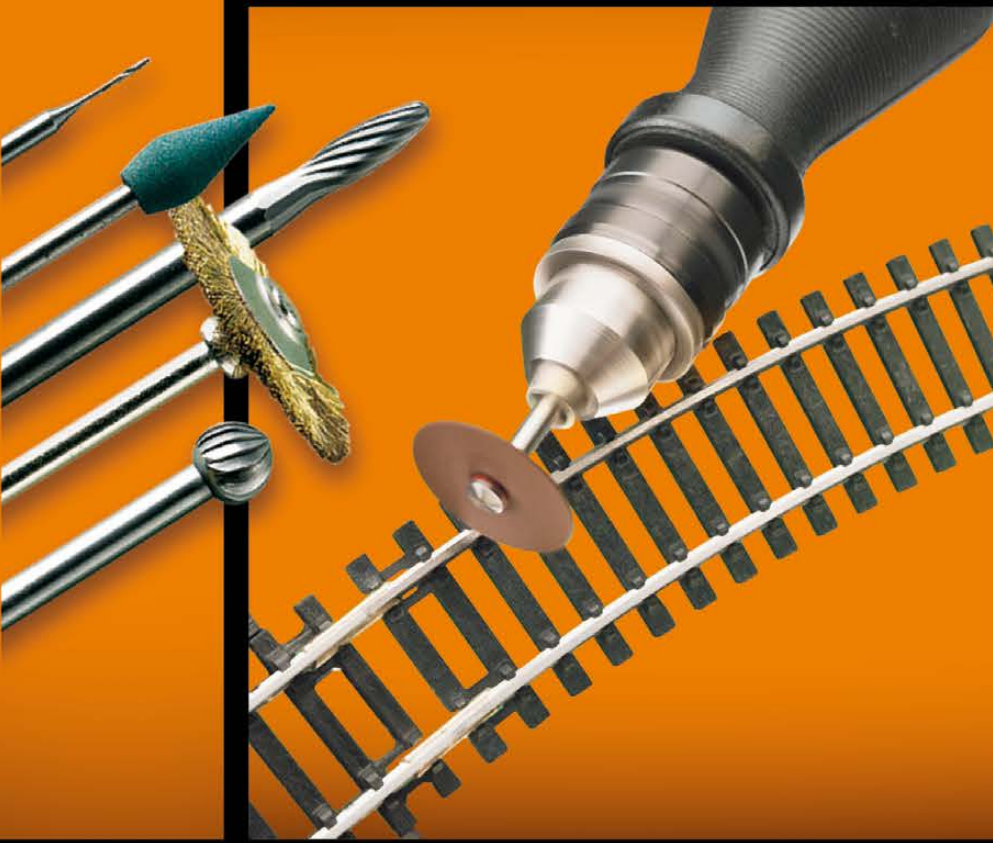

INTAGLIO INCISIONE FRESATURA



SMERIGLIATURA AFFILATURA



LEVIGATURA



PULITURA LUCIDATURA



TAGLIO SGROSSATURA



PUNTE HSS PER FORATURA



ACCESSORI VARI



TRAPANI TRASFORMATORI KIT



mini

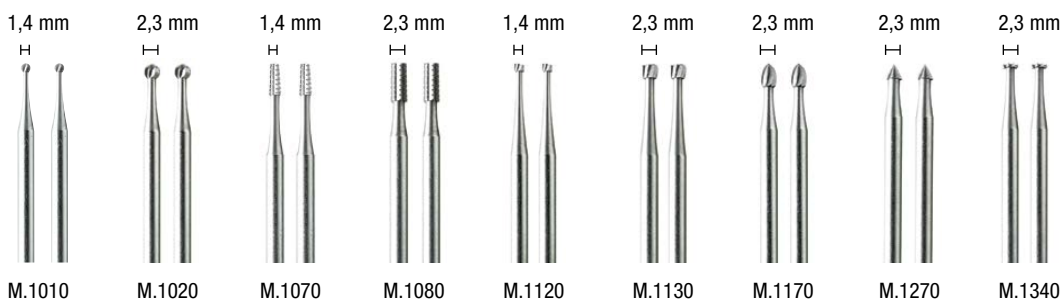

FRESE IN ACCIAIO

Per l'intaglio, l'incisione e la svasatura di legno, fibra di vetro, metalli teneri e plastica

M.1010	2 frese ø 1,4 mm - sfera - gambo ø 2,35 mm	5	090009
M.1020	2 frese ø 2,3 mm - sfera - gambo ø 2,35 mm	5	090016
M.1070	2 frese ø 1,4 mm - cilindrica - gambo ø 2,35 mm	5	090023
M.1080	2 frese ø 2,3 mm - cilindrica - gambo ø 2,35 mm	5	090030
M.1120	2 frese ø 1,4 mm - cono rovesciato - gambo ø 2,35 mm	5	090047
M.1130	2 frese ø 2,3 mm - cono rovesciato - gambo ø 2,35 mm	5	090054
M.1170	2 frese ø 2,3 mm - fiamma - gambo ø 2,35 mm	5	090061
M.1270	2 frese ø 2,3 mm - punta - gambo ø 2,35 mm	5	090078
M.1340	2 frese ø 2,3 mm - ruota - gambo ø 2,35 mm	5	090085



FRESE IN ACCIAIO

Per l'intaglio, l'incisione, la fresatura di precisione, la scanalatura e la svasatura di legno, fibra di vetro, metalli teneri e plastica

M.1030	ø 4,0 mm - sfera - gambo ø 2,35 mm	5	090092
M.1050	ø 6,0 mm - sfera - gambo ø 3,0 mm	5	090108
M.1065	ø 7,8 mm - ovale - gambo ø 3,20 mm	5	092928
M.1100	ø 6,0 mm - cilindrica - gambo ø 3,0 mm	5	090115
M.1105	ø 7,8 mm - cilindrica - gambo ø 3,20 mm	5	092935
M.1140	ø 4,0 mm - cono rovesciato - gambo ø 2,35 mm	5	090122
M.1190	ø 4,0 mm - conica fiamma - gambo ø 2,35 mm	5	090139
M.1240	ø 6,0 mm - conica - gambo ø 3,0 mm	5	090146
M.1310	ø 6,0 mm - punta - gambo ø 3,0 mm	5	090153
M.1370	ø 6,0 mm - ruota - gambo ø 3,0 mm	5	090160
M.1375	ø 9,5 mm - ruota - gambo ø 3,20 mm	5	092942

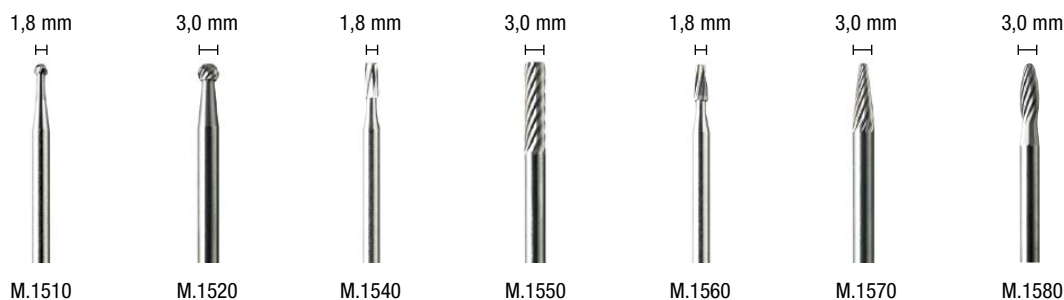

FRESE AL CARBURO DI TUNGSTENO

Per l'asportazione di materiale, la levigatura e la modellatura. Adatte per acciaio temprato, acciaio inox, ghisa, materiali non ferrosi, ceramica temprata, legno, plastica e altri materiali duri

M.1510	∅ 1,8 mm - sfera - gambo ∅ 2,35 mm	5	090177
M.1520	∅ 3,0 mm - sfera - gambo ∅ 3,0 mm	5	090184
M.1540	∅ 1,8 mm - cilindrica - gambo ∅ 2,35 mm	5	090191
M.1550	∅ 3,0 mm - cilindrica - gambo ∅ 3,0 mm	5	090207
M.1560	∅ 1,8 mm - conica - gambo ∅ 2,35 mm	5	090214
M.1570	∅ 3,0 mm - conica - gambo ∅ 3,0 mm	5	090221
M.1580	∅ 3,0 mm - fiamma - gambo ∅ 3,0 mm	5	090238

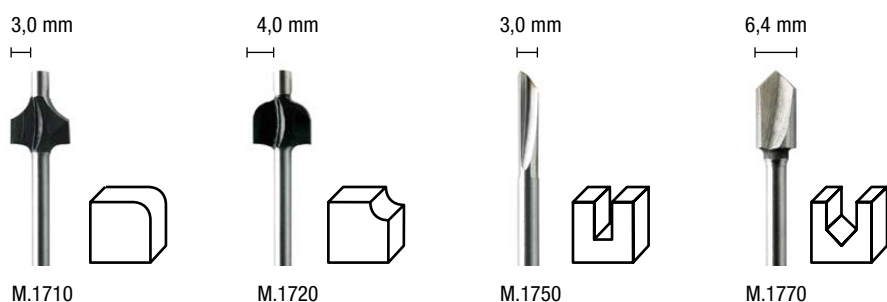

FRESE IN HSS PER LEGNO

Per rifinire bordi ed ottenere diversi tipi di scanalature e profili

M.1710	r = 3,0 mm - per profili convessi - gambo ∅ 3,0 mm	2	090320
M.1720	r = 4,0 mm - per profili concavi - gambo ∅ 3,0 mm	2	090337
M.1750	∅ 3,0 mm - per scanalature diritte - gambo ∅ 3,0 mm	2	090344
M.1770	∅ 6,4 mm - per scanalature a V - gambo ∅ 3,0 mm	2	090351



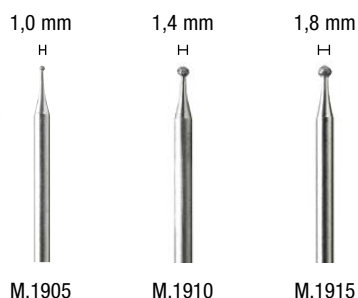

PUNTE DIAMANTATE

Rivestite con particelle di diamante, sono indicate per lavori di particolare precisione, quali l'incisione, l'intaglio, ritocchi o rifiniture su materiali come vetro, ceramica, pietre semipreziose, metalli, legno e altri materiali duri

M.1905	∅ 1,0 mm - sfera - gambo ∅ 2,35 mm	5	090245
M.1910	∅ 1,4 mm - sfera - gambo ∅ 2,35 mm	5	090252
M.1915	∅ 1,8 mm - sfera - gambo ∅ 2,35 mm	5	090269

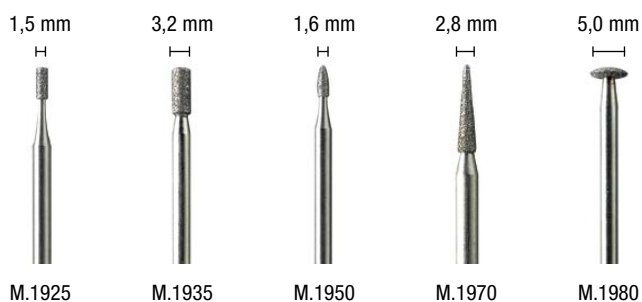

FRESE DIAMANTATE

Rivestite con particelle di diamante, sono indicate per lavori di particolare precisione, quali l'incisione, l'intaglio, ritocchi o rifiniture su materiali come vetro, ceramica, pietre semipreziose, metalli, legno e altri materiali duri

M.1925	∅ 1,5 mm - cilindrica - gambo ∅ 2,35 mm	5	090276
M.1935	∅ 3,2 mm - cilindrica - gambo ∅ 2,35 mm	5	090283
M.1950	∅ 1,6 mm - fiamma - gambo ∅ 2,35 mm	5	090290
M.1970	∅ 2,8 mm - punta - gambo ∅ 2,35 mm	5	090306
M.1980	∅ 5,0 mm - disco - gambo ∅ 2,35 mm	5	090313

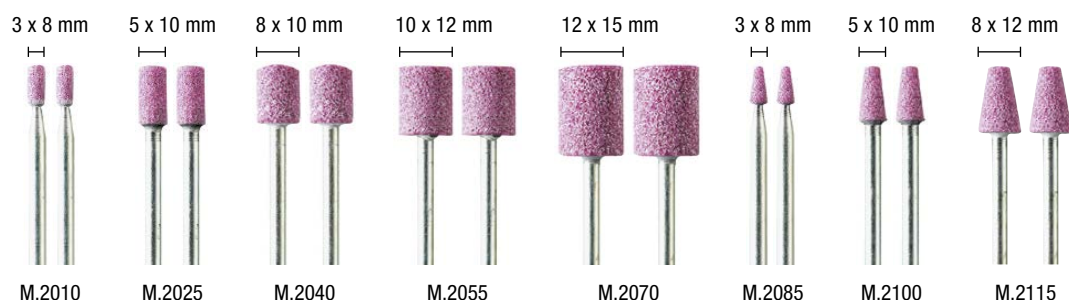
**MOLE ABRASIVE IN RUBINO**

Ad elevato potere abrasivo. Per l'affilatura, la sbavatura e lavori di smerigliatura della maggior parte dei materiali. Particolarmente indicate per lavori di rettifica di precisione

M.2010	2 mole \varnothing 3 x 8 mm - cilindrica - gambo \varnothing 3,0 mm	5	090368
M.2025	2 mole \varnothing 5 x 10 mm - cilindrica - gambo \varnothing 3,0 mm	5	090375
M.2040	2 mole \varnothing 8 x 10 mm - cilindrica - gambo \varnothing 3,0 mm	5	090382
M.2055	2 mole \varnothing 10 x 12 mm - cilindrica - gambo \varnothing 3,0 mm	5	090399
M.2070	2 mole \varnothing 12 x 15 mm - cilindrica - gambo \varnothing 3,0 mm	5	090405
M.2085	2 mole \varnothing 3 x 8 mm - conica - gambo \varnothing 2,35 mm	5	090412
M.2100	2 mole \varnothing 5 x 10 mm - conica - gambo \varnothing 2,35 mm	5	090429
M.2115	2 mole \varnothing 8 x 12 mm - conica - gambo \varnothing 3,0 mm	5	090436

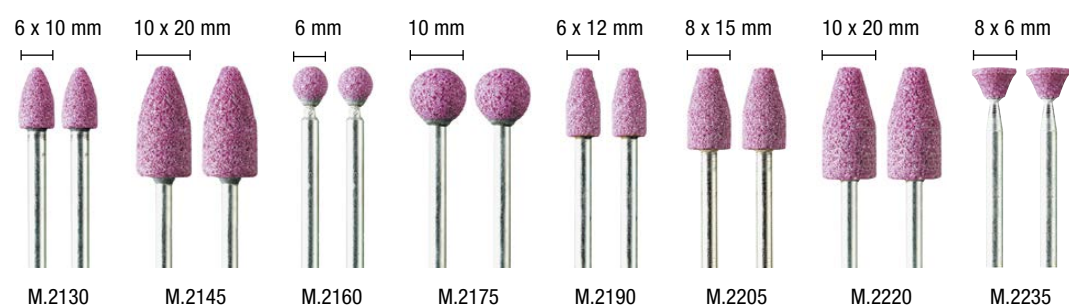
**MOLE ABRASIVE IN RUBINO**

Ad elevato potere abrasivo. Per l'affilatura, la sbavatura e lavori di smerigliatura della maggior parte dei materiali. Particolarmente indicate per lavori di rettifica di precisione

M.2130	2 mole \varnothing 6 x 10 mm - ogiva - gambo \varnothing 3,0 mm	5	090443
M.2145	2 mole \varnothing 10 x 20 mm - ogiva - gambo \varnothing 3,0 mm	5	090450
M.2160	2 mole \varnothing 6 mm - sfera - gambo \varnothing 3,0 mm	5	090467
M.2175	2 mole \varnothing 10 mm - sfera - gambo \varnothing 3,0 mm	5	090474
M.2190	2 mole \varnothing 6 x 12 mm - cilindrica conica - gambo \varnothing 3,0 mm	5	090481
M.2205	2 mole \varnothing 8 x 15 mm - cilindrica conica - gambo \varnothing 3,0 mm	5	090498
M.2220	2 mole \varnothing 10 x 20 mm - cilindrica conica - gambo \varnothing 3,0 mm	5	090504
M.2235	2 mole \varnothing 8 x 6 mm - conica rovesciata - gambo \varnothing 3,0 mm	5	090511





MOLE ABRASIVE IN CARBURO DI SILICIO

Ad elevatissimo potere abrasivo. Per l'affilatura di utensili in metallo duro. Adatte per l'incisione e la lavorazione di pietra, vetro, cristalli, ceramica e porcellana

M.2410	2 mole ø 3 x 8 mm - conica arrotondata - gambo ø 2,35 mm	5	090528
M.2420	2 mole ø 5 x 10 mm - conica arrotondata - gambo ø 2,35 mm	5	090535
M.2435	2 mole ø 4 mm - sfera - gambo ø 3,0 mm	5	090542
M.2450	2 mole ø 8 x 6 mm - conica rovesciata - gambo ø 3,0 mm	5	090559
M.2465	2 mole ø 6 x 10 mm - semi sfera - gambo ø 3,0 mm	5	090566
M.2480	2 mole ø 5 x 10 mm - fiamma - gambo ø 3,0 mm	5	090573

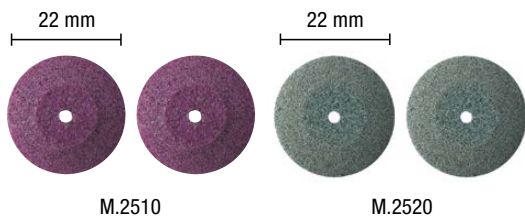

MOLE ABRASIVE LENTICOLARI

M.2510	2 mole ø 22 mm - in abrasivo rubino	5	090580
M.2520	2 mole ø 22 mm - in carburo di silicio	5	090597

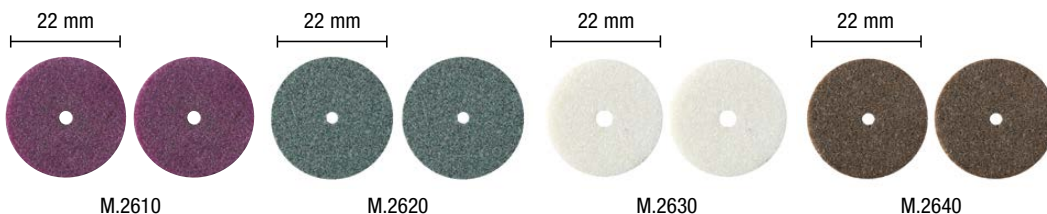

RUOTINE ABRASIVE

M.2610	2 mole ø 22 mm - in abrasivo rubino	5	090603
M.2620	2 mole ø 22 mm - in carburo di silicio	5	090610
M.2630	2 mole ø 22 mm - in abrasivo bianco	5	090627
M.2640	2 mole ø 22 mm - in abrasivo marrone	5	090634

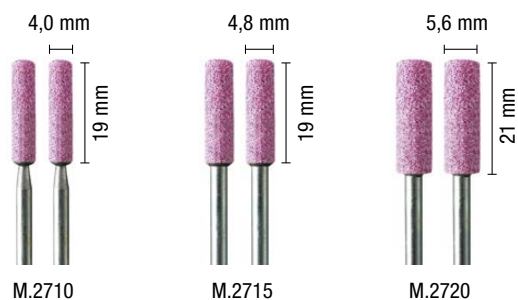
**MOLE ABRASIVE IN RUBINO PER AFFILATURA CATENE**

Ad alto potere abrasivo per l'affilatura di seghe a catena

M.2710	2 mole \varnothing 4,0 x 19 mm - cilindrica - gambo \varnothing 3,0 mm	5	090641
M.2715	2 mole \varnothing 4,8 x 19 mm - cilindrica - gambo \varnothing 3,0 mm	5	090658
M.2720	2 mole \varnothing 5,6 x 21 mm - cilindrica - gambo \varnothing 3,0 mm	5	090665

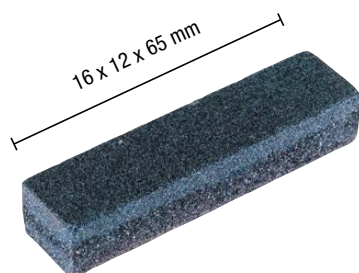

M.2910

RAVVIVAMOLE

Per la ravnivatura, la pulitura e la rimodellatura delle mole abrasive

M.2910	16 x 12 x 65 mm - doppia grana	5	090672
---------------	--------------------------------	---	--------





20 mm - grana 80



M.3020

30 mm - grana 80



M.3030

RUOTE LAMELLARI ABRASIVE

Per levigare e lucidare superfici piane o di difficile accesso. Adatte per metallo, legno, gomma, plastica e per rimuovere la ruggine

M.3020	ø 20 x 5 mm - gambo ø 3,0 mm - grana 80	5	090689
M.3030	ø 30 x 10 mm - gambo ø 3,0 mm - grana 80	5	090696



M.3210

grana 100 - 220



20 mm - grana 100

10 x



M.3220

20 mm - grana 220

10 x



M.3230

PLATORELLO IN GOMMA E DISCHI ABRASIVI ADESIVI

Per levigare, smerigliare legno, plastica, gomma e rimuovere la ruggine dal metallo

M.3210	platorello in gomma ø 20 mm - gambo ø 3,2 mm - 6 dischi abrasivi - grane assortite	5	090702
M.3220	10 dischi abrasivi ø 20 mm - grana 100	5	090719
M.3230	10 dischi abrasivi ø 20 mm - grana 220	5	090726



M.3610

13 mm - grana 60

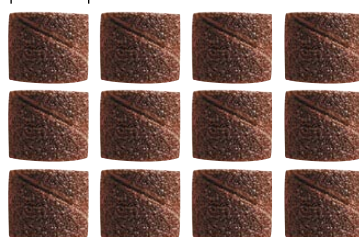

M.3620

13 mm - grana 120



M.3630

SMERIGLIATORE AD ESPANSIONE E NASTRI ABRASIVI

Per levigare, smerigliare legno, plastica, gomma e rimuovere la ruggine dal metallo

M.3610	smerigliatore ad espansione ø 13 x 13 mm - gambo ø 3,2 mm	5	090733
M.3620	12 nastri abrasivi ø 13 mm - grana 60	5	090740
M.3630	12 nastri abrasivi ø 13 mm - grana 120	5	090757

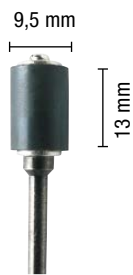

M.3640

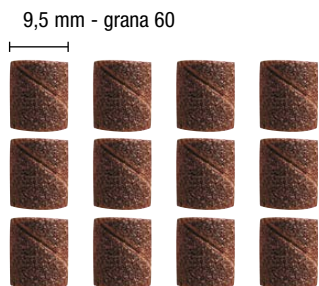

M.3650

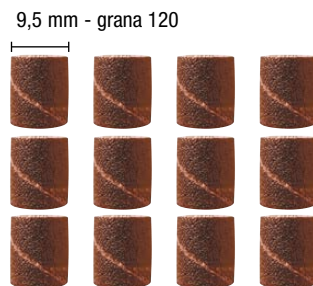

M.3660



SMERIGLIATORE AD ESPANSIONE E NASTRI ABRASIVI

Per levigare, smerigliare legno, plastica, gomma e rimuovere la ruggine dal metallo

M.3640	smerigliatore ad espansione \varnothing 9,5 x 13 mm - gambo \varnothing 3,2 mm	5	092959
M.3650	12 nastri abrasivi \varnothing 9,5 mm - grana 60	5	092966
M.3660	12 nastri abrasivi \varnothing 9,5 mm - grana 120	5	092973



M.3670

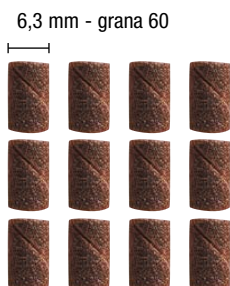

M.3680

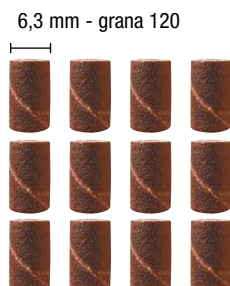

M.3690



SMERIGLIATORE AD ESPANSIONE E NASTRI ABRASIVI

Per levigare, smerigliare legno, plastica, gomma e rimuovere la ruggine dal metallo

M.3670	smerigliatore ad espansione \varnothing 6,3 x 13 mm - gambo \varnothing 3,2 mm	5	092980
M.3680	12 nastri abrasivi \varnothing 6,3 mm - grana 60	5	092997
M.3690	12 nastri abrasivi \varnothing 6,3 mm - grana 120	5	093000



SPAZZOLE IN ACCIAIO: per pulire e sbavare metallo, legno, plastica. Adatte per l'eliminazione di ruggine e corrosione, per la sbavatura e la pulitura di punti di saldatura

SPAZZOLE IN OTTONE: per pulire, sbavare e lucidare legno, metalli teneri, oro, rame e ottone senza produrre graffi. Indicate per la pulitura di componenti elettrici

M.4005	Ø 5 mm - pennello in acciaio - gambo Ø 2,35 mm	5	090764
M.4010	Ø 12 mm - tazza in acciaio - gambo Ø 2,35 mm	5	090771
M.4015	Ø 21 mm - circolare in acciaio - gambo Ø 2,35 mm	5	090788
M.4020	3 spazzole assortite in acciaio	5	090795
M.4055	Ø 5 mm - pennello in ottone - gambo Ø 2,35 mm	5	090801
M.4060	Ø 12 mm - tazza in ottone - gambo Ø 2,35 mm	5	090818
M.4065	Ø 21 mm - circolare in ottone - gambo Ø 2,35 mm	5	090825
M.4070	3 spazzole assortite in ottone	5	090832



SPAZZOLE IN SETOLA NERA: per tutti i lavori di leggera sbavatura, pulitura e lucidatura. Particolarmente indicate per argenteria, gioielli e altri materiali preziosi

SPAZZOLE IN NYLON BIANCO: per la pulizia e la lucidatura di metalli preziosi ed altre superfici delicate

M.4105	Ø 5 mm - pennello in setola nera - gambo Ø 2,35 mm	5	090849
M.4110	Ø 12 mm - tazza in setola nera - gambo Ø 2,35 mm	5	090856
M.4115	Ø 21 mm - circolare in setola nera - gambo Ø 2,35 mm	5	090863
M.4120	3 spazzole assortite in setola nera	5	090870
M.4155	Ø 5 mm - pennello in nylon bianco - gambo Ø 2,35 mm	5	090887
M.4160	Ø 12 mm - tazza in nylon bianco - gambo Ø 2,35 mm	5	090894
M.4165	Ø 21 mm - circolare in nylon bianco - gambo Ø 2,35 mm	5	090900
M.4170	3 spazzole assortite in nylon bianco	5	090917

**TAMPONI IN SILICONE BIANCO**

Lucidanti universali per la lisciatura di leghe preziose, ceramica, porcellane e smalti

M.4305	∅ 12 mm - disco - gambo ∅ 2,35 mm	5	090924
M.4310	∅ 12 mm - lenticolare - gambo ∅ 2,35 mm	5	090931

**PUNTE IN GOMMA BLU**

Per la finitura, la lucidatura, l'eliminazione di graffi e imperfezioni e la pulitura degli intagli su ceramica, materiali ferrosi e sulla maggior parte delle pietre

M.4505	∅ 6,0 mm - fiamma - gambo ∅ 3,0 mm	5	090948
M.4510	∅ 5,0 mm - ogiva - gambo ∅ 3,0 mm	5	090955
M.4515	∅ 6,0 mm - cilindrica - gambo ∅ 3,0 mm	5	090962

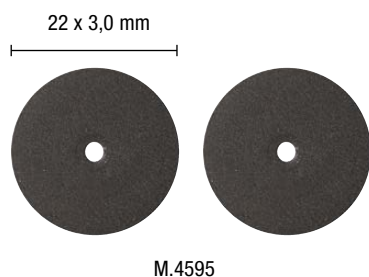
**DISCO IN GOMMA MARRONE**

Per lucidare ed eliminare graffi su materiali ferrosi, pietre e ceramiche

M.4595	2 dischi ∅ 22 x 3,0 mm	5	090979
---------------	------------------------	---	--------



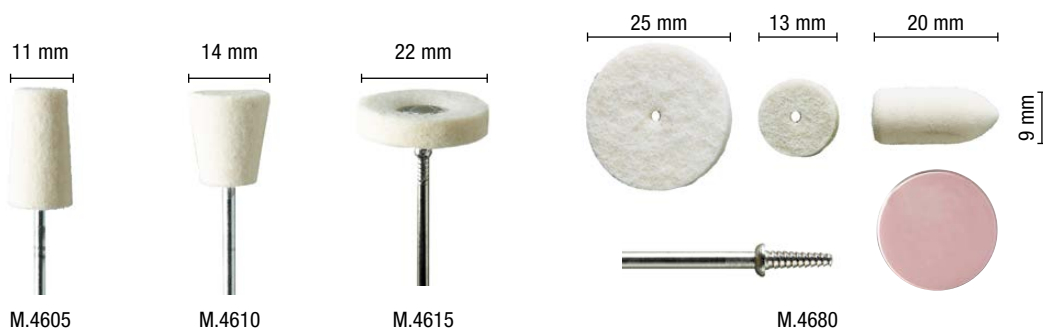

DISCHI IN FELTRO

Per la lucidatura di metalli, vetro, ceramica, metalli preziosi, pietre e plastica

M.4605	Ø 11 mm - cono - gambo Ø 2,35 mm	5	090986
M.4610	Ø 14 mm - cono rovesciato - gambo Ø 2,35 mm	5	090993
M.4615	Ø 22 mm - ruota - gambo Ø 2,35 mm	5	091006
M.4680	kit 3 feltri assortiti + alberino a piramide + pasta rosa	5	091013

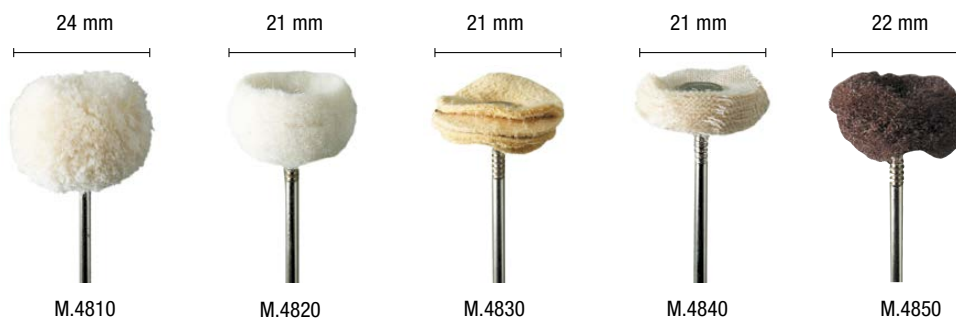

DISCHI IN COTONE, FELTRO MORBIDO, CAMOSCIO E IN LAMELLE DI COTONE:
per la lucidatura di metalli, oro, argento, metalli non ferrosi, ottone, alluminio, vetro

DISCO ABRASIVO "SCOTCH FABRIC": per la pulitura e la satinatura di vetro, legno, plastica, alluminio, acciaio, acciaio inox e altri metalli

M.4810	Ø 24 mm - in cotone morbido - gambo Ø 2,35 mm	5	091020
M.4820	Ø 21 mm - in feltro morbido - gambo Ø 2,35 mm	5	091037
M.4830	Ø 21 mm - in camoscio - gambo Ø 2,35 mm	5	091044
M.4840	Ø 21 mm - in lamelle di cotone - gambo Ø 2,35 mm	5	091051
M.4850	Ø 22 mm - in abrasivo "scotch fabric" - gambo Ø 2,35 mm	5	091068



PASTE PER LUCIDATURA

Da abbinare agli accessori in feltro e cotone. Per eliminare superfici appannate ed ossidate e/o leggere irregolarità superficiali

M.4905	pasta rosa per pre-lucidatura - universale	5	091075
M.4910	pasta bianca per lucidatura finale - universale	5	091082
M.4915	pasta abrasiva rossa per rame, ottone, bronzo	5	091099

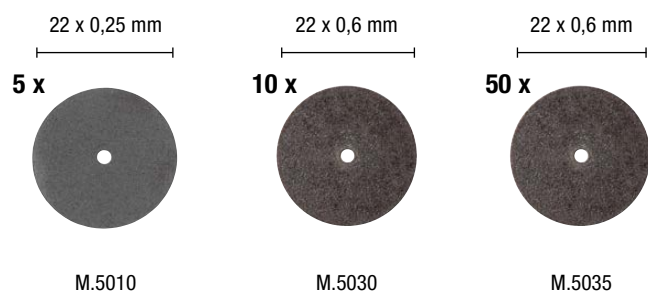
**DISCHI DA TAGLIO**

M.5010 Adatti al taglio e alla scanalatura del vetro, lamiere, legno sottile e plastica

M.5030 - M.5035 Ideali per il taglio o la scanalatura di bulloni, viti, lamiere metalliche, legno sottile e plastica

M.5010	5 dischi ø 22 x 0,25 mm - slim	5	091105
M.5030	10 dischi ø 22 x 0,6 mm	5	091112
M.5035	50 dischi ø 22 x 0,6 mm	5	091129

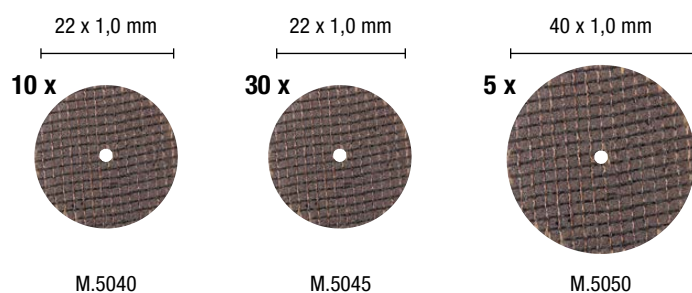
**DISCHI DA TAGLIO RINFORZATI**

Ideali per il taglio o la scanalatura di bulloni, viti, lamiere metalliche, legno sottile e plastica

M.5040	10 dischi ø 22 x 1,0 mm	5	093680
M.5045	30 dischi ø 22 x 1,0 mm	5	093697
M.5050	5 dischi ø 40 x 1,0 mm	5	091136

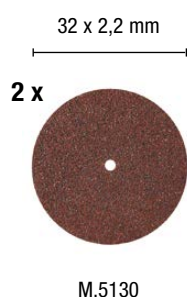
**DISCHI PER SGROSSARE**

Per la sgrossatura e la scanalatura di metalli, ceramica e plastica

M.5130	2 dischi ø 32 x 2,2 mm	5	091143
---------------	------------------------	---	--------



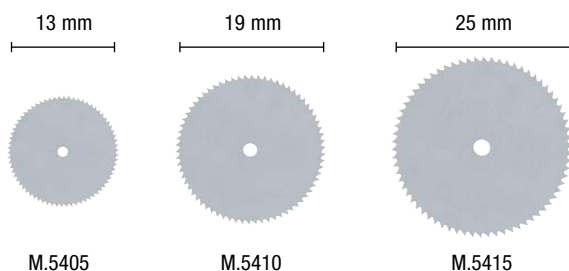

MINI LAME IN ACCIAIO

Per tagliare plastica (schede elettroniche), legno e metalli non ferrosi

M.5405	∅ 13 mm	5	091150
M.5410	∅ 19 mm	5	091167
M.5415	∅ 25 mm	5	091174

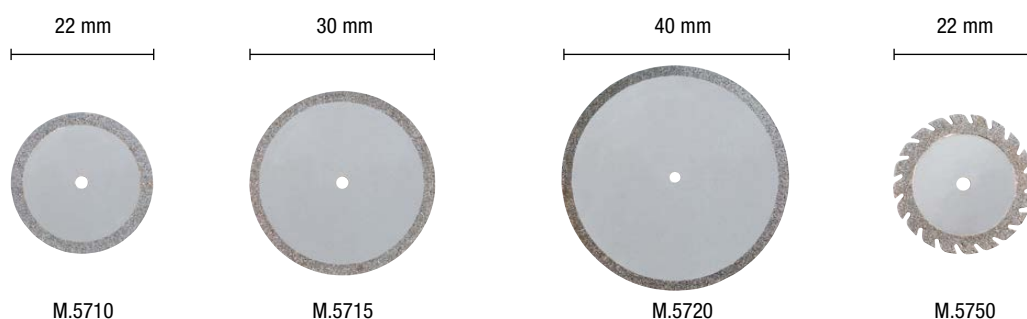

DISCO DIAMANTATO

Per tagliare e smerigliare materiali più duri del metallo, come marmo, pietra, porcellana, ceramica e resine dure. Estrema precisione nel taglio e lunga durata

M.5710	∅ 22 mm	5	091181
M.5715	∅ 30 mm	5	093314
M.5720	∅ 40 mm	5	093321
M.5750	∅ 22 mm - segmentato	5	093338

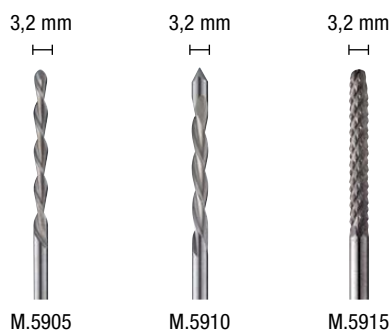

PUNTE DA TAGLIO A SPIRALE

M.5905 Per tagliare legno, plastica e fibra di vetro

M.5910 Per tagliare cartongesso

M.5915 Per tagliare piastrelle di ceramica, gesso e pannelli di cemento

M.5905	∅ 3,2 mm - gambo ∅ 3,2 mm	5	093345
M.5910	∅ 3,2 mm - gambo ∅ 3,2 mm	5	093352
M.5915	∅ 3,2 mm - gambo ∅ 3,2 mm	5	093369

Una gamma completa di punte HSS per forare con precisione legno, metallo e plastica

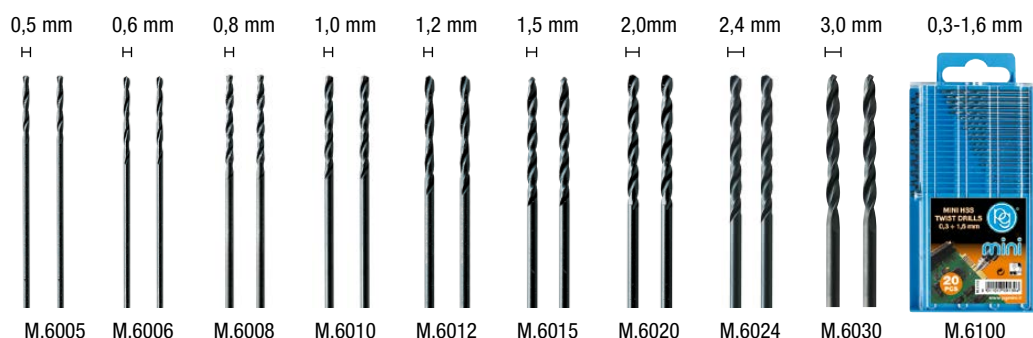

PUNTE IN ACCIAIO HSS

M.6005	2 punte ø 0,5 mm	5	091198
M.6006	2 punte ø 0,6 mm	5	091204
M.6008	2 punte ø 0,8 mm	5	091211
M.6010	2 punte ø 1,0 mm	5	091228
M.6012	2 punte ø 1,2 mm	5	091235
M.6015	2 punte ø 1,5 mm	5	091242
M.6020	2 punte ø 2,0 mm	5	091259
M.6024	2 punte ø 2,4 mm	5	091266
M.6030	2 punte ø 3,0 mm	5	091273
M.6100	kit 20 punte ø 0,3 - 0,35 - 0,4 - 0,45 - 0,5 - 0,55 - 0,6 - 0,65 - 0,7 - 0,75 - 0,8 - 0,85 - 0,9 - 0,95 - 1,0 - 1,2 - 1,3 - 1,4 - 1,5 - 1,6 mm	2	091396

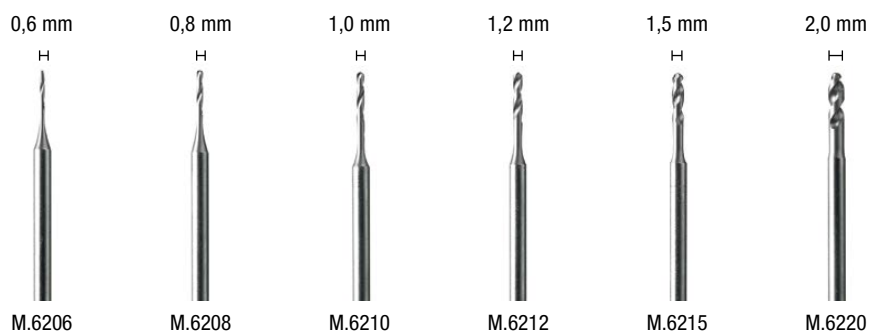

PUNTE IN ACCIAIO HSS RINFORZATE

M.6206	ø 0,6 mm - gambo ø 2,35 mm	5	091280
M.6208	ø 0,8 mm - gambo ø 2,35 mm	5	091297
M.6210	ø 1,0 mm - gambo ø 2,35 mm	5	091303
M.6212	ø 1,2 mm - gambo ø 2,35 mm	5	091310
M.6215	ø 1,5 mm - gambo ø 2,35 mm	5	091327
M.6220	ø 2,0 mm - gambo ø 2,35 mm	5	091334



1,0 mm 1,5 mm 2,35 mm 3,0 mm 3,2 mm



M.8010 (Minicraft, PG Mini, Proxxon)

0,8 mm 2,35 mm 3,0 mm 3,2 mm



M.8020 (B&D, Dremel)

PINZE

M.8010	kit pinze ø 1,0 - 1,5 - 2,35 - 3,0 - 3,2 mm e ghiera di serraggio	2	093017
M.8020	kit pinze ø 0,8 - 2,35 - 3,0 - 3,2 mm e ghiera di serraggio	2	093024



M.8100

M.8110

M.8120

ALBERINI

M.8100	alberino a vite - gambo ø 3,0 mm	5	091358
M.8110	alberino rinforzato a vite - gambo ø 2,35 mm	5	091365
M.8120	alberino a piramide - gambo ø 3,0 mm	5	091372



CAVO PROLUNGA

M.8305	cavo prolunga 5 m	1	091402
---------------	-------------------	---	--------

codice

caratteristiche

q.tà
imballo

EAN13
8011017

ACCESSORI VARI

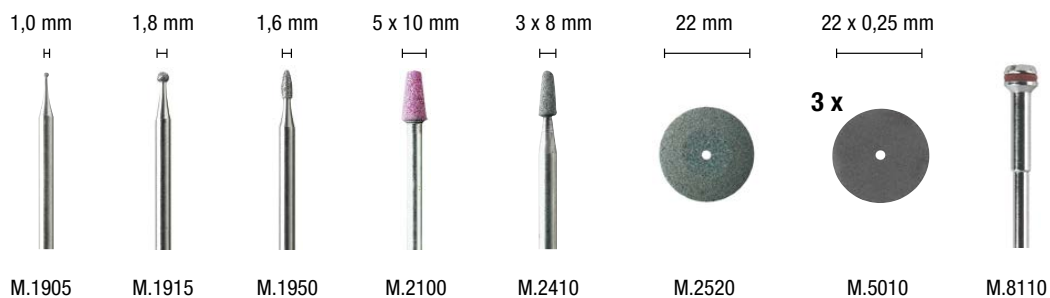

M.8210

M.8210 kit 10 accessori per incisioni

2

093031



M.8230

M.8230 kit 10 accessori per smerigliatura ed affilatura

2

093048

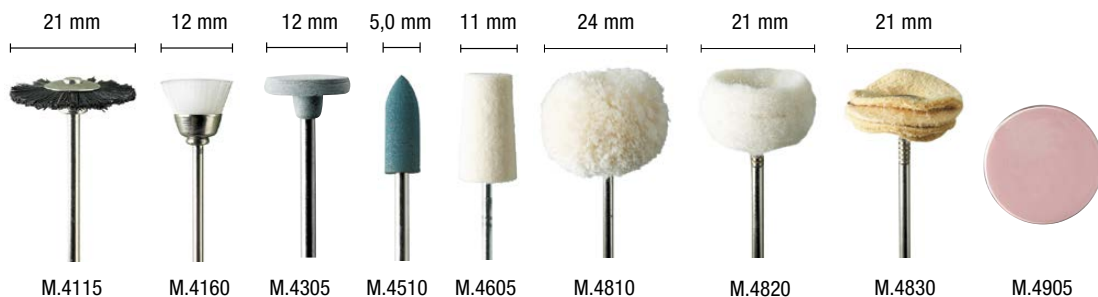

M.8250

M.8250 kit 9 accessori per lucidatura e pulitura

2

093055

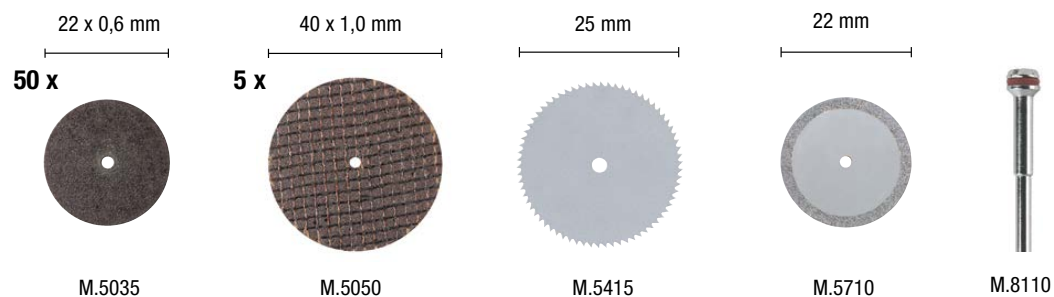

M.8270

M.8270 kit 58 accessori per taglio

2

093062





ALBERO FLESSIBILE per lavori accurati e di precisione in punti difficilmente accessibili

M.8500	- lunghezza 80 cm - con 3 pinze assortite (ø 2,35 - 3,0 - 3,2 mm) e 1 ghiera - 30.000 RPM	1	091426
---------------	---	----------	--------

0,4-3,2 mm



M.8550 (Minicraft, PG Mini, Proxxon)

0,4-3,2 mm



M.8560 (B&D, Dremel)

0,4-6,0 mm



M.8580 (M.9400, M.9500, M.9600)

**MANDRINI**

M.8550	mandrino autoserrante ø 0,4-3,2 mm - filettatura 8 x 0,75 - 10.000 RPM	1	091389
M.8560	mandrino autoserrante ø 0,4-3,2 mm - filettatura 9/32" x 40 - 10.000 RPM	1	093376
M.8580	mandrino a cremagliera con chiave e adattatore - ø 0,4-6,0 mm - filettatura 8 x 0,75 - 10.000 RPM	1	093598

**MINI BOX PORTA ACCESSORI**

M.BOX01	- modulare, in plastica antiurto - con rinforzi in gomma morbida antiscivolo - dimensioni 16,5 x 12 x 6,5 cm	1	088228
----------------	---	----------	--------



M.8600



M.8710



SUPPORTI ORIENTABILI PER MINI TRAPANO

M.8600	- posizionamento multidirezionale del trapano - ideale con l'albero flessibile art. M.8500 - collare ø 43 mm + collare di riduzione ø 33 mm	1	091433
M.8710	collare girevole ø 32/48 mm - inclinazione e altezza regolabili - scorrimento a cremagliera con molla di ritorno e arresto di profondità - altezza 260 mm - corsa 27 mm - luce (distanza albero/centro mandrino) 115 mm - altezza lavoro 100 mm - asta ø 16 mm - base in alluminio 250 x 180 mm	1	093666



MINI MORSA

M.8750	- larghezza 45 mm - apertura 50 mm	1	093383
---------------	---	---	--------



KIT SVITA E AVVITA DI PRECISIONE - 45 PEZZI

M.8775	1 flessibile - 1 pinza di precisione 35 inserti assortiti - 1 cacciavite - 7 bussole	1	093574
---------------	---	---	--------



**KIT CUTTER DI PRECISIONE - 18 PEZZI**

Ideali per lavori di precisione su plastica, pannelli in ABS, legno, compensato, carta e cartone

M.8790

- 1 impugnatura in bi-materiale antiscivolo per materiali leggeri e medi, con attacco rapido delle lame
- 1 impugnatura in bi-materiale antiscivolo per materiali spessi, con attacco rapido delle lame
- 14 lame di precisione assortite
- 1 cacciavite di precisione
- 1 pinza di precisione

1

093581



Voltaggio	230 V / 50 Hz
Potenza	30 Watt
Temperatura	450/500 °C
Lung. cavo	1,2 m
Peso	94 g

PIROGRAFO

Per incidere legno, cuoio naturale, zucche, carta spessa, vimini e rattan

M.8800

- corpo in ABS
- con 2 punte (universale e conica)
- con supporto di appoggio

1

093550

PISTOLE TERMOCOLLANTI

Ugello con protezione termica, dispositivo antigoccia. Ad avanzamento automatico. Corpo in plastica antiurto. Per incollare carta, plastica, legno, ceramica, tessuti



Voltaggio	230 V / 50 Hz
Potenza	20 Watt
Lung. cavo	1,8 m
Peso	170 g



M.8820	pistola termocollante con 2 stick di colla ø 7 mm	1	093529
---------------	---	----------	--------



Voltaggio	230 V / 50 Hz
Potenza	30 Watt
Lung. cavo	1,8 m
Peso	200 g



M.8815	- pistola termocollante con 2 stick di colla ø 7 mm - con pulsante di accensione/spegnimento - base di appoggio autoportante	1	093703
---------------	--	----------	--------



Voltaggio	230 V / 50 Hz
Potenza	60 Watt
Lung. cavo	1,8 m
Peso	330 g



M.8845	- pistola termocollante con 2 stick di colla ø 11 mm - con pulsante di accensione/spegnimento - base di appoggio autoportante	1	093710
---------------	---	----------	--------

STICK COLLA A CALDO

M.8822	12 stick di colla ø 7 mm - lunghezza 100 mm	10	600000
M.8857	12 stick di colla ø 11 mm - lunghezza 100 mm	10	600208



Voltaggio	230 V / 50 Hz
Voltaggio secondario	15 V DC
Uscite	max 12 VA
Velocità	singola *
Lunghezza cavo	2 m
Peso	520 g

* la velocità dipende dall'utensile impiegato

TRASFORMATORE AD UNA VELOCITÀ

M.9000	- potenza sufficiente per tutti gli utensili da 6, 25, 30 e 40 Watt	1	091440
	- protezione anti-sovraccarico per una maggiore sicurezza e una più lunga durata dell'utensile stesso		



Voltaggio	0-18 Vcc
Potenza	6 Watt
Velocità a vuoto	0-17.000 RPM
Capacità porta punta	ø 2,35 mm
Lunghezza cavo	1,8 m
Peso	75 g

PENNA PER INCISIONI

M.9200	- design a penna per un comodo utilizzo	1	091488
	- interruttore ON/OFF a sfioramento per un agevole impiego		
	- semplice cambio degli accessori ad incastro		
	- rotazione veloce per un efficace lavoro di incisione		
	- dotato di 1 punta diamantata		
	- disponibile in kit art. M.9250		



Voltaggio	230 V / 50 Hz
Potenza	6 Watt
Velocità a vuoto	0-17.000 RPM
Capacità porta punte	Ø 2,35 mm
Lunghezza cavo	1,8 m
Peso	220 g

PENNA PER INCISIONI CON TRASFORMATORE

M.9220	<ul style="list-style-type: none"> - design a penna per un comodo utilizzo - interruttore ON/OFF a sfioramento per un agevole impiego - semplice cambio degli accessori ad incastro - rotazione veloce per un efficace lavoro di incisione - dotato di 1 punta diamantata - disponibile in kit art. M.9250 	1	093628



KIT PER INCISIONI 6 W

M.9250	<ul style="list-style-type: none"> - penna per incisioni art. M.9200 - trasformatore a spina - 1 punta diamantata - 3 mole su perno - 2 stencil - comoda valigetta 	1	091495



Voltaggio	0-18 V DC
Potenza	30 Watt
Velocità a vuoto	0-30.000 RPM
Tipo di mandrino	autoserrante
Capacità mandrino	Ø 0,4-3,2 mm
Lunghezza cavo	1,8 m
Peso	125 g

TRAPANO AD ALTA COPPIA

M.9100	<ul style="list-style-type: none"> - mandrino autoserrante per agevolare il cambio degli accessori - alta velocità per svariate applicazioni - impugnatura a penna per facilitarne l'impiego - dotato di 3 pinze assortite (Ø 2,35 - 3,0 - 3,2 mm) e 1 ghiera per una maggiore flessibilità - disponibile in kit art. M.9150 	1	091464



KIT MINI TRAPANO 30 W

M.9150	<ul style="list-style-type: none"> - trapano ad alta coppia art. M.9100 - trasformatore ad una velocità art. M.9000 - 29 accessori selezionati - comoda valigetta 	1	091471

codice

caratteristiche

q.tà
imballo

EAN13
8011017

**TRAPANI
TRASFORMATORI
KIT**



Voltaggio	230 V / 50 Hz
Potenza	60 Watt
Velocità a vuoto	8.000-18.000 RPM
Tipo di mandrino	pinza
Lunghezza cavo	1,8 m
Peso	805 g

TRAPANO DI PRECISIONE CON TRASFORMATORE

M.9300	<ul style="list-style-type: none"> - corpo ergonomicamente progettato per una comoda impugnatura - velocità variabile per una maggiore precisione - pulsante di blocco albero - dotato di 5 pinze assortite (Ø 1,0 - 1,5 - 2,35 - 3,0 - 3,2 mm) e 1 ghiera per una maggiore flessibilità - disponibile in kit art. M.9350 	1	093604



KIT MINI TRAPANO DI PRECISIONE 60 W

M.9350	<ul style="list-style-type: none"> - trapano di precisione art. M.9300 - trasformatore - 62 accessori selezionati - comoda valigetta 	1	093611



Voltaggio	230 V / 50 Hz
Potenza	130 Watt
Velocità a vuoto	8.000-32.000 RPM
Tipo di mandrino	autoserrante
Capacità mandrino	Ø 0,4-3,2 mm
Lunghezza cavo	1,9 m
Peso	630 g

TRAPANO AD ALTA COPPIA

M.9500	<ul style="list-style-type: none"> - mandrino autoserrante per agevolare il cambio degli accessori - corpo ergonomicamente progettato per una comoda impugnatura - motore potente e velocità variabile per svariate applicazioni - pulsante di blocco albero - dotato di 3 pinze assortite (Ø 2,35 - 3,0 - 3,2 mm) e 1 ghiera per una maggiore flessibilità - non richiede trasformatore - disponibile in kit art. M.9550 	1	093116



KIT TRAPANO ALTA COPPIA 130 W

M.9550	<ul style="list-style-type: none"> - trapano a velocità variabile ad alta coppia art. M.9500 - 60 accessori selezionati - comoda valigetta 	1	093123



Voltaggio	230 V / 50 Hz
Potenza	170 Watt
Velocità a vuoto	8.000-32.000 RPM
Tipo di mandrino	autoserrante
Capacità mandrino	Ø 0,4-3,2 mm
Lunghezza cavo	1,9 m
Peso	665 g



TRAPANO AD ALTA COPPIA

M.9600	<ul style="list-style-type: none"> - mandrino autoserrante per agevolare il cambio degli accessori - display digitale/controllo velocità: per lavorazioni più precise sui diversi materiali - corpo ergonomicamente progettato per una comoda impugnatura - motore potente e velocità variabile per svariate applicazioni - pulsante di blocco albero - dotato di 3 pinze assortite (Ø 2,35 - 3,0 - 3,2 mm) e 1 ghiera per una maggiore flessibilità - non richiede trasformatore - disponibile in kit art. M.9650 	1	093413



KIT TRAPANO ALTA COPPIA DISPLAY LCD 170 W

M.9650	<ul style="list-style-type: none"> - trapano a velocità variabile con display digitale art. M.9600 - 60 accessori selezionati - comoda valigetta 	1	093420



Totale referenze 36		Totale pezzi 162	
5x M.1010	5x M.1030	5x M.1080	5x M.1100
5x M.2040	5x M.2070	5x M.2100	5x M.2410
5x M.3630	5x M.4020	5x M.4070	5x M.4680
5x M.5415	5x M.5710	5x M.5715	4x M.8010
5x M.5010	5x M.5030	5x M.5050	5x M.5410
4x M.8020	5x M.8100	5x M.8110	4x M.6100
5x M.1240	5x M.1270	5x M.1915	5x M.1970
5x M.3030	5x M.3210	5x M.3610	5x M.3620
1x M.9150	2x M.9250	1x M.9350	1x M.9550

ESPOSITORE DA BANCO*

ESPO.M3A

- altezza **82** cm
- larghezza **46** cm
- profondità **32** cm

1

093727



Totale referenze 32		Totale pezzi 141	
5x M.1010	5x M.1030	5x M.1080	5x M.1100
5x M.2070	5x M.2100	5x M.2610	5x M.3030
5x M.4020	5x M.4070	5x M.4680	5x M.5030
5x M.5050	5x M.5410	5x M.5710	5x M.8100
4x M.8210	4x M.8230	4x M.8250	4x M.8270
1x M.9150	2x M.9250	1x M.9350	1x M.9550
5x M.1240	5x M.1270	5x M.1915	5x M.1970
5x M.3640	5x M.3650	5x M.3660	

ESPOSITORE DA BANCO*

ESPO.M3B

- altezza **85** cm
- larghezza **46** cm
- profondità **32** cm

1

093734



**Totale
referenze
148**

**Totale
pezzi
709**

Totale referenze: 148		Totale pezzi: 709	
mini			
4x M. 6100	5x M. 4680	5x M. 2910	5x M. 1010
5x M. 6005	5x M. 4810	5x M. 3020	5x M. 1020
5x M. 6006	5x M. 4820	5x M. 3030	5x M. 1070
5x M. 6008	5x M. 4830	5x M. 3210	5x M. 1080
5x M. 6010	5x M. 4840	5x M. 3220	5x M. 1120
5x M. 6012	5x M. 4850	5x M. 3230	5x M. 1170
5x M. 6020	5x M. 4905	5x M. 3610	5x M. 1270
5x M. 6206	5x M. 4910	5x M. 3620	5x M. 1030
5x M. 6208	5x M. 4915	5x M. 3630	5x M. 1050
5x M. 6210	5x M. 5010	5x M. 3640	5x M. 1065
5x M. 6212	5x M. 5030	5x M. 3650	5x M. 1100
5x M. 6215	5x M. 5050	5x M. 3660	5x M. 1105
4x M. 8010	5x M. 5130	5x M. 3670	5x M. 1190
4x M. 8020	5x M. 5405	5x M. 3680	5x M. 1240
5x M. 8100	5x M. 5410	5x M. 3690	5x M. 1310
5x M. 8110	5x M. 5415	5x M. 4005	5x M. 1375
5x M. 8120	5x M. 5710	5x M. 4010	5x M. 1510
4x M. 8550	5x M. 5715	5x M. 4605	5x M. 1540
4x M. 8560	5x M. 5720	5x M. 4610	5x M. 1550
4x M. 8580	5x M. 5730	5x M. 4615	5x M. 1580
3x M. 9300	3x M. 9500	3x M. 9600	
4x M. 8210	4x M. 8230	4x M. 8250	
4x M. 8270	3x M. 8800	3x M. 8500	
3x M. 8790	3x M. 8775	3x M. 8815	
3x M. 8845	20x M. 8857	20x M. 8822	
2x M. 9250	2x M. 9150	2x M. 8710	
2x M. 9650	2x M. 9350	2x M. 9550	

ESPOSITORE DA PARETE*

ESPO.M3C	- altezza 206 cm	1	093741
	- larghezza 100 cm		
	- profondità 40 cm		

* La composizione base degli espositori è personalizzabile.

INDICE NUMERICO: ARTICOLI, QUANTITÀ E CODICI A BARRE

Anteporre al codice EAN il prefisso 8011017

ref.	descrizione	ean	pag.	ref.	descrizione	ean	pag.
10.010	2 PUNTE HSS 1 MM	100104	88	13.740	SEGA A TAZZA BIMETAL 127MM	137407	75
10.015	2 PUNTE HSS 1,5 MM	100159	88	13.745	SEGA A TAZZA BIMETAL 140MM	137452	75
10.020	2 PUNTE HSS 2 MM	100203	88	13.750	SEGA A TAZZA BIMETAL 152MM	137506	75
10.025	2 PUNTE HSS 2,5 MM	100258	88	13.780	ALBERO PER BIMETAL 14/30MM	137803	74
10.030	2 PUNTE HSS 3 MM	100302	88	13.785	ALBERO PER BIMETAL 32/152MM	137858	74
10.035	2 PUNTE HSS 3,5 MM	100357	88	13.790	ALBERO PER BIMETAL 14/30MM	137902	74
10.040	2 PUNTE HSS 4 MM	100401	88	13.795	ALBERO PER BIMETAL 32/152MM	137957	74
10.045	PUNTA HSS 4,5 MM	100456	88	13.800	PUNTA ALBERO BIMETAL 115MM	138008	74
10.050	PUNTA HSS 5 MM	100500	88	13.805	PUNTA ALBERO BIMETAL 70MM	138053	74
10.055	PUNTA HSS 5,5 MM	100555	88	14.003	PUNTA LEGNO 3MM SFUSA	140032	90
10.060	PUNTA HSS 6 MM	100609	88	14.004	PUNTA LEGNO 4MM SFUSA	140049	90
10.065	PUNTA HSS 6,5 MM	100654	88	14.005	PUNTA LEGNO 5MM SFUSA	140056	90
10.070	PUNTA HSS 7 MM	100708	88	14.006	PUNTA LEGNO 6MM SFUSA	140063	90
10.075	PUNTA HSS 7,5 MM	100753	88	14.007	PUNTA LEGNO 7MM SFUSA	140070	90
10.080	PUNTA HSS 8 MM	100807	88	14.008	PUNTA LEGNO 8MM SFUSA	140087	90
10.085	PUNTA HSS 8,5 MM	100852	88	14.009	PUNTA LEGNO 9MM SFUSA	140094	90
10.090	PUNTA HSS 9 MM	100906	88	14.010	PUNTA LEGNO 10MM SFUSA	140100	90
10.095	PUNTA HSS 9,5 MM	100951	88	14.011	PUNTA LEGNO 11MM SFUSA	140117	90
10.100	PUNTA HSS 10 MM	101002	88	14.012	PUNTA LEGNO 12MM SFUSA	140124	90
10.105	PUNTA HSS 10,5MM	101057	88	14.013	PUNTA LEGNO 13MM SFUSA	140131	90
10.110	PUNTA HSS 11 MM	101101	88	14.014	PUNTA LEGNO 14MM SFUSA	140148	90
10.115	PUNTA HSS 11,5MM	101156	88	14.015	PUNTA LEGNO 15MM SFUSA	140155	90
10.120	PUNTA HSS 12 MM	101200	88	14.016	PUNTA LEGNO 16MM SFUSA	140162	90
10.125	PUNTA HSS 12,5MM	101255	88	14.018	PUNTA LEGNO 18MM SFUSA	140186	90
10.130	PUNTA HSS 13 MM	101309	88	14.020	PUNTA LEGNO 20MM SFUSA	140209	90
103.1/4	FRESA HOBBY ESTERNA 1/2	103143	8	14.022	PUNTA LEGNO 22MM SFUSA	140223	90
103.6MA	FRESA HOBBY ESTERNA 1/2	103006	8	14.024	PUNTA LEGNO 24MM SFUSA	140247	90
11.010	FRESA 10MM 6MA	110103	9	14.026	PUNTA LEGNO 26MM SFUSA	140261	90
11.012	FRESA 12MM 6MA	110127	9	14.028	PUNTA LEGNO 28MM SFUSA	140285	90
11.014	FRESA 14MM 6MA 3/8	110141	9	14.030	PUNTA LEGNO 30MM SFUSA	140308	90
11.017	FRESA 17MM 6MA 1/2	110172	9	14.206	PUNTA LEGNO 6X250MM	142067	90
11.024	FRESA 24MM 6MA 3/4	110240	9	14.207	PUNTA LEGNO 7X250MM	142074	90
11.028	FRESA 28MM 6MA 1"	110288	9	14.208	PUNTA LEGNO 8X250MM	142081	90
11.034	FRESA 34MM 1/4 1"1/8	5 110349	9	14.209	PUNTA LEGNO 9X250MM	142098	90
11.038	FRESA 38MM 1/4 1"1/4	5 110387	9	14.210	PUNTA LEGNO 10X250MM	142104	90
11.043	FRESA 43MM 1/4 1"1/2	5 110431	9	14.211	PUNTA LEGNO 11X250MM	142111	90
11.055	FRESA 55MM 1/4 2"	5 110554	9	14.212	PUNTA LEGNO 12X250MM	142128	90
12.010	PUNTA FORSTNER 10MM	1 120102	42	14.213	PUNTA LEGNO 13X250MM	142135	90
12.012	PUNTA FORSTNER 12MM	1 120126	42	14.214	PUNTA LEGNO 14X250MM	142142	90
12.014	PUNTA FORSTNER 14MM	1 120140	42	14.215	PUNTA LEGNO 15X250MM	142159	90
12.015	PUNTA FORSTNER 15MM	1 120157	42	14.216	PUNTA LEGNO 16X250MM	142166	90
12.016	PUNTA FORSTNER 16MM	1 120164	42	14.218	PUNTA LEGNO 18X250MM	142180	90
12.018	PUNTA FORSTNER 18MM	1 120188	42	14.220	PUNTA LEGNO 20X250MM	142203	90
12.020	PUNTA FORSTNER 20MM	1 120201	42	14.222	PUNTA LEGNO 22X250MM	142227	90
12.022	PUNTA FORSTNER 22MM	1 120225	42	14.224	PUNTA LEGNO 24X250MM	142241	90
12.024	PUNTA FORSTNER 24MM	1 120249	42	15.030	PUNTA WIDIA 3MM	10 150307	89
12.025	PUNTA FORSTNER 25MM	1 120256	42	15.040	PUNTA WIDIA 4MM	10 150406	89
12.026	PUNTA FORSTNER 26MM	1 120263	42	15.050	PUNTA WIDIA 5MM	10 150505	89
12.028	PUNTA FORSTNER 28MM	1 120287	42	15.060	PUNTA WIDIA 6MM	10 150604	89
12.030	PUNTA FORSTNER 30MM	1 120300	42	15.070	PUNTA WIDIA 7MM	10 150703	89
12.032	PUNTA FORSTNER 32MM	1 120324	42	15.080	PUNTA WIDIA 8MM	10 150802	89
12.034	PUNTA FORSTNER 34MM	1 120348	42	15.090	PUNTA WIDIA 9MM	10 150901	89
12.035	PUNTA FORSTNER 35MM	1 120355	42	15.100	PUNTA WIDIA 10MM	10 151007	89
12.036	PUNTA FORSTNER 36MM	1 120362	42	15.120	PUNTA WIDIA 12MM	10 151205	89
12.040	PUNTA FORSTNER 40MM	1 120409	42	15.140	PUNTA WIDIA 14MM	10 151403	89
12.045	PUNTA FORSTNER 45MM	1 120454	42	15.606	SET 5 PUNTE LEGNO 4/10MM	2 156064	91
12.050	PUNTA FORSTNER 50MM	1 120508	42	15.607	SET 8 PUNTE LEGNO 3/10MM	2 156071	91
13.500	SEGA A TAZZA BIMETAL 14MM	1 135007	75	15.608	SET 5 PUNTE MURO 4/10MM	2 156088	91
13.505	SEGA A TAZZA BIMETAL 16MM	1 135052	75	15.610	SET 8 PUNTE MURO 3/10MM	2 156101	91
13.510	SEGA A TAZZA BIMETAL 17MM	1 135106	75	15.615	SET 13 PUNTE HSS 1,5/6,5MM	2 156156	91
13.515	SEGA A TAZZA BIMETAL 19MM	1 135151	75	15.620	SET 13 PUNTE HSS 2/8MM	2 156200	91
13.520	SEGA A TAZZA BIMETAL 20MM	1 135205	75	15.630	SET 9 PUNTE HSS-MURO	2 156309	91
13.525	SEGA A TAZZA BIMETAL 21MM	1 135250	75	15.640	SET 9 PUNTE HSS-MURO-LEGNO	2 156408	91
13.530	SEGA A TAZZA BIMETAL 22MM	1 135304	75	16.030	PUNTA WIDIA 3MM SFUSA	10 160306	89
13.535	SEGA A TAZZA BIMETAL 24MM	1 135359	75	16.040	PUNTA WIDIA 4MM SFUSA	10 160405	89
13.540	SEGA A TAZZA BIMETAL 25MM	1 135403	75	16.050	PUNTA WIDIA 5MM SFUSA	10 160504	89
13.545	SEGA A TAZZA BIMETAL 27MM	1 135458	75	16.055	PUNTA WIDIA 5,5MM SFUSA	10 160559	89
13.550	SEGA A TAZZA BIMETAL 29MM	1 135502	75	16.060	PUNTA WIDIA 6MM SFUSA	10 160603	89
13.555	SEGA A TAZZA BIMETAL 30MM	1 135557	75	16.065	PUNTA WIDIA 6,5MM SFUSA	10 160658	89
13.560	SEGA A TAZZA BIMETAL 32MM	1 135601	75	16.070	PUNTA WIDIA 7MM SFUSA	10 160702	89
13.565	SEGA A TAZZA BIMETAL 33MM	1 135656	75	16.080	PUNTA WIDIA 8MM SFUSA	10 160801	89
13.570	SEGA A TAZZA BIMETAL 35MM	1 135700	75	16.090	PUNTA WIDIA 9MM SFUSA	10 160900	89
13.575	SEGA A TAZZA BIMETAL 37MM	1 135755	75	16.100	PUNTA WIDIA 10MM SFUSA	10 161006	89
13.580	SEGA A TAZZA BIMETAL 38MM	1 135809	75	16.110	PUNTA WIDIA 11MM SFUSA	10 161105	89
13.585	SEGA A TAZZA BIMETAL 40MM	1 135854	75	16.120	PUNTA WIDIA 12MM SFUSA	10 161204	89
13.590	SEGA A TAZZA BIMETAL 41MM	1 135908	75	16.130	PUNTA WIDIA 13MM SFUSA	10 161303	89
13.595	SEGA A TAZZA BIMETAL 43MM	1 135953	75	16.140	PUNTA WIDIA 14MM SFUSA	10 161402	89
13.600	SEGA A TAZZA BIMETAL 44MM	1 136004	75	16.150	PUNTA WIDIA 15MM SFUSA	10 161501	89
13.605	SEGA A TAZZA BIMETAL 46MM	1 136059	75	16.160	PUNTA WIDIA 16MM SFUSA	10 161600	89
13.610	SEGA A TAZZA BIMETAL 48MM	1 136103	75	16.180	PUNTA WIDIA 18MM SFUSA	5 161808	89
13.615	SEGA A TAZZA BIMETAL 51MM	1 136158	75	16.200	PUNTA WIDIA 20MM SFUSA	5 162003	89
13.620	SEGA A TAZZA BIMETAL 52MM	1 136202	75	16.408	PUNTA WIDIA 8X400MM	1 164083	89
13.625	SEGA A TAZZA BIMETAL 54MM	1 136257	75	16.410	PUNTA WIDIA 10X400MM	1 164106	89
13.630	SEGA A TAZZA BIMETAL 57MM	1 136301	75	16.412	PUNTA WIDIA 12X400MM	1 164120	89
13.635	SEGA A TAZZA BIMETAL 59MM	1 136356	75	16.414	PUNTA WIDIA 14X400MM	1 164144	89
13.640	SEGA A TAZZA BIMETAL 60MM	1 136400	75	16.416	PUNTA WIDIA 16X400MM	1 164168	89
13.645	SEGA A TAZZA BIMETAL 64MM	1 136455	75	16.418	PUNTA WIDIA 18X400MM	1 164182	89
13.650	SEGA A TAZZA BIMETAL 65MM	1 136509	75	16.420	PUNTA WIDIA 20X400MM	1 164205	89
13.655	SEGA A TAZZA BIMETAL 67MM	1 136554	75	16.422	PUNTA WIDIA 22X400MM	1 164229	89
13.660	SEGA A TAZZA BIMETAL 70MM	1 136608	75	16.425	PUNTA WIDIA 25X400MM	1 164250	89
13.665	SEGA A TAZZA BIMETAL 73MM	1 136653	75	16.610	PUNTA WIDIA 10X600MM	1 166100	89
13.670	SEGA A TAZZA BIMETAL 76MM	1 136707	75	16.612	PUNTA WIDIA 12X600MM	1 166124	89
13.675	SEGA A TAZZA BIMETAL 79MM	1 136752	75	16.614	PUNTA WIDIA 14X600MM	1 166148	89
13.680	SEGA A TAZZA BIMETAL 83MM	1 136806	75	16.616	PUNTA WIDIA 16X600MM	1 166162	89
13.685	SEGA A TAZZA BIMETAL 86MM	1 136851	75	16.618	PUNTA WIDIA 18X600MM	1 166186	89
13.690	SEGA A TAZZA BIMETAL 89MM	1 136905	75	16.620	PUNTA WIDIA 20X600MM	1 166209	89
13.695	SEGA A TAZZA BIMETAL 92MM	1 136950	75	17.010	PUNTA HSS 1 MM SFUSA	10 170107	88
13.700	SEGA A TAZZA BIMETAL 95MM	1 137001	75	17.015	PUNTA HSS 1,5 MM SFUSA	10 170152	88
13.705	SEGA A TAZZA BIMETAL 98MM	1 137056	75	17.020	PUNTA HSS 2 MM SFUSA	10 170206	88
13.710	SEGA A TAZZA BIMETAL 102MM	1 137100	75	17.025	PUNTA HSS 2,5 MM SFUSA	10 170251	88
13.715	SEGA A TAZZA BIMETAL 105MM	1 137155	75	17.030	PUNTA HSS 3 MM SFUSA	10 170305	88
13.720	SEGA A TAZZA BIMETAL 108MM	1 137209	75	17.035	PUNTA HSS 3,5 MM SFUSA	10 170350	88
13.725	SEGA A TAZZA BIMETAL 111MM	1 137254	75	17.040	PUNTA HSS 4 MM SFUSA	10 170404	88
13.730	SEGA A TAZZA BIMETAL 114MM	1 137308	75	17.045	PUNTA HSS 4,5 MM SFUSA	10 170459	88
13.735	SEGA A TAZZA BIMETAL 121MM	1 137353	75	17.050	PUNTA HSS 5 MM SFUSA	10 170503	88

INDICE NUMERICO: ARTICOLI, QUANTITÀ E CODICI A BARRE

Anteporre al codice EAN il prefisso 8011017

ref.	descrizione	ean	pag.	ref.	descrizione	ean	pag.
17.055	PUNTA HSS 5,5 MM SFUSA	10 170558	88	339.35	RUOTA IN TESSUTO 100MM	10 339351	15
17.060	PUNTA HSS 6 MM SFUSA	10 170602	88	339.40	RUOTA IN TESSUTO 120MM	10 339405	15
17.065	PUNTA HSS 6,5 MM SFUSA	10 170657	88	339.45	RUOTA IN TESSUTO 150MM	10 339450	15
17.070	PUNTA HSS 7 MM SFUSA	10 170701	88	339.46	RUOTA IN SISAL E COTONE 80MM	10 339467	16
17.075	PUNTA HSS 7,5 MM SFUSA	10 170756	88	339.49	RUOTA IN SISAL E COTONE 150MM	10 339498	16
17.080	PUNTA HSS 8 MM SFUSA	10 170800	88	339.50	TAMPONE PER LUCIDARE 125MM	1 339504	16
17.085	PUNTA HSS 8,5 MM SFUSA	10 170855	88	339.60	TAMPONE PER LUCIDARE 175MM M14	1 339603	16
17.090	PUNTA HSS 9 MM SFUSA	10 170909	88	339.62	TAMPONE PER LUCIDARE 125MM	1 339627	16
17.095	PUNTA HSS 9,5 MM SFUSA	10 170954	88	339.64	TAMPONE PER LUCIDARE 175MM	1 339641	16
17.100	PUNTA HSS 10 MM SFUSA	10 171005	88	339.66	TAMPONE PER LUCIDARE VEL 115MM	1 339665	16
17.105	PUNTA HSS 10,5MM SFUSA	10 171050	88	339.67	TAMPONE PER LUCIDARE VEL 125MM	1 339672	16
17.110	PUNTA HSS 11 MM SFUSA	10 171104	88	339.68	TAMPONE PER LUCIDARE VEL 160MM	1 339689	16
17.115	PUNTA HSS 11,5MM SFUSA	10 171159	88	339.70	TAMPONE GOMMA 125X70MM	10 339702	18
17.120	PUNTA HSS 12 MM SFUSA	10 171203	88	339.72	TAMPONE GOMMA 125X70MM VELCRO	5 339726	18
17.125	PUNTA HSS 12,5MM SFUSA	10 171258	88	339.73	TAMPONE GOMMA VELCRO 125MM	5 339733	18
17.130	PUNTA HSS 13 MM SFUSA	10 171302	88	339.74	TAMPONE GOMMA VELCRO 125MM	5 339740	18
17.135	PUNTA HSS 13,5MM SFUSA	5 171357	88	339.75	TAMPONE GOMMA VELCRO 125MM	5 339757	18
17.140	PUNTA HSS 14 MM SFUSA	5 171401	88	339.76	TAMPONE GOMMA VELCRO 150MM	5 339764	18
17.145	PUNTA HSS 14,5MM SFUSA	5 171456	88	339.79	MINI-TAMPONE GOMMA VELCRO	5 339795	18
17.150	PUNTA HSS 15 MM SFUSA	5 171500	88	339.80	SPUGNA ABRASIVA GR.60/100	10 339801	18
17.155	PUNTA HSS 15,5MM SFUSA	5 171555	88	339.81	25 SPUGNE ABRASIVE GR.60/100	1 339818	18
17.160	PUNTA HSS 16 MM SFUSA	5 171609	88	339.85	24 SPUGNE ABRASIVE GR.60/100	1 339856	18
201.1/4	FRESA ESTERNA 3/8-1"	1 201146	8	339.90	2 SPUGNE ABRASIVE GR.100	10 339900	18
201.6MA	FRESA ESTERNA 3/8-1"	1 201009	8	339.91	250 SPUGNE ABRASIVE GR.100	1 339917	18
202.1/4	FRESA ESTERNA INTERNA 3/8-1"	1 202143	8	340.00	15 DISCHI CARTA 125 GR. 50	10 340005	19
202.6MA	FRESA ESTERNA INTERNA 3/8-1"	1 202006	8	341.00	15 DISCHI CARTA 125 GR. 80	10 341002	19
203.6MA	FRESA ESTERNA 1/2-3/4	1 203003	8	342.00	15 DISCHI CARTA 125 GR.120	10 342009	19
204.1/4	FRESA ESTERNA 1"1/8-2"	1 204147	8	343.00	15 DISCHI CARTA 125 ASSORTITI	10 343006	19
205.6MA	FRESA ESTERNA 3/8-1"	1 205007	8	344.00	5 DISCHI CARTA 125 GR. 50	10 344003	19
207.6MA	FRESA DOPPIO CONO + CONO 40	1 207001	8	344.10	5 DISCHI CARTA 125 GR. 80	10 344102	19
208.6MA	FRESA DOPPIO CONO GRANDE	1 208008	8	344.20	5 DISCHI CARTA 125 GR.120	10 344201	19
209.6MA	FRESA DOPPIO CONO PICCOLA	1 209005	8	344.30	5 DISCHI CARTA 125 ASSORTITI	10 344300	19
210.6MA	FRESA CILINDRICA 3/8-1"	1 210001	9	345.10	DISCO TUNGSTENO 125 GR.MEDIA	10 345109	30
212.1/4	FRESA HOBBY ESTERNA 3/8-1/2	10 212142	8	345.20	DISCO TUNGSTENO 125 GR.FINE	10 345208	30
212.6MA	FRESA HOBBY ESTERNA 3/8-1/2	10 212005	8	347.00	6 DISCHI FIBRA 115 GR. 36	10 347004	19
213.6MA	FRESA HOBBY CILINDRICA 3/8-1/2	10 213002	9	347.10	6 DISCHI FIBRA 115 GR. 60	10 347103	19
214.00	FORALASTRA 20/123MM	5 214009	12	347.20	6 DISCHI FIBRA 115 GR.100	10 347202	19
214.10	UTENSILE HSS QUADRO 5 214.00	5 214108	12	348.00	6 DISCHI FIBRA 180 GR. 36	10 348001	19
215.00	FORALASTRA 25/217MM	5 215006	12	348.10	6 DISCHI FIBRA 180 GR. 60	10 348100	19
215.10	UTENSILE HSS QUADRO 6 215.00	5 215105	12	348.20	6 DISCHI FIBRA 180 GR.100	10 348209	19
216.00	FORALASTRA 27/104MM	5 216003	12	348.25	10 FOGLI VELCRO GR. 60 339.79	5 348254	18
216.10	UTENSILE HSS TONDO 5 216.00	5 216102	12	348.26	10 FOGLI VELCRO GR.120 339.79	5 348261	18
217.00	TAGLIPIASTRELLE CIRCOLARE	1 217000	74	348.27	10 FOGLI VELCRO GR.240 339.79	5 348278	18
217.10	UTENSILE PER ART. 217.00	1 217109	74	348.30	5 FOGLI VELCRO FORATI GR. 40	10 348308	20
218.00	GHIERA CONICA 14MM	10 218007	13	348.31	25 FOGLI VELCRO FORATI GR. 40	1 348315	20
219.00	GHIERA PIANA 14MM	10 219004	13	348.35	5 FOGLI VELCRO FORATI GR. 60	10 348353	20
220.00	GHIERA CONICA 8MA SFUSA	10 220000	13	348.36	25 FOGLI VELCRO FORATI GR. 60	1 348360	20
220.50	GHIERA CONICA 10MA SFUSA COL16	10 220505	13	348.40	5 FOGLI VELCRO FORATI GR. 80	10 348407	20
221.00	GHIERA CONICA 10MA SFUSA	10 221007	13	348.41	25 FOGLI VELCRO FORATI GR. 80	1 348414	20
222.00	GHIERA CONICA 14MA SFUSA	10 222004	13	348.45	5 FOGLI VELCRO FORATI GR.120	10 348452	20
223.00	GHIERA CONICA 5/8 SFUSA	10 223001	13	348.46	25 FOGLI VELCRO FORATI GR.120	1 348469	20
224.00	GHIERA PIANA 8MA SFUSA	10 224008	13	348.50	5 FOGLI VELCRO FORATI GR.240	10 348506	20
225.00	GHIERA PIANA 10MA SFUSA	10 225005	13	348.51	25 FOGLI VELCRO FORATI GR.240	1 348513	20
226.00	GHIERA PIANA 14MA SFUSA	10 226002	13	348.56	25 FOGLI VELCRO FORATI GR.ASS.	1 348568	20
227.00	GHIERA PIANA 5/8 SFUSA	10 227009	13	349.00	10 DISCHI VELCRO 115 GR. 40	10 349008	20
228.00	CHIAVE SERVIZIO GHIERE 35MM	10 228006	13	349.01	25 DISCHI VELCRO 115 GR. 40	1 349015	20
229.00	CHIAVE SERVIZIO GHIERE 35MM SF	10 229003	13	349.10	10 DISCHI VELCRO 115 GR.120	10 349107	20
230.00	CHIAVE REGOLABILE GHIERE 20/35	10 230009	13	349.11	25 DISCHI VELCRO 115 GR.120	1 349114	20
231.00	CHIAVE REGOLABILE GHIERE 20/35	10 231006	13	349.20	10 DISCHI VELCRO 115 GR.240	10 349206	20
250.00	FLANGIA POST.POGGIA DISCO 115	1 250007	13	349.21	25 DISCHI VELCRO 115 GR.240	1 349213	20
253.00	FLANGIA POST.POGGIA DISCO 230	1 253008	13	349.30	10 DISCHI VELCRO 115 GR.ASS	10 349305	20
300.00	MORSETTO ALLARGATUBI 10/16MM	1 300009	9	349.31	25 DISCHI VELCRO 115 GR.ASS	1 349312	20
304.00	MORSETTO ALLARGATUBI 10/22MM	1 304007	9	349.33	10 DISCHI VELCRO FO 115 GR. 40	10 349336	21
305.00	CHIAVE PER LAVABO	5 305004	10	349.34	25 DISCHI VELCRO FO 115 GR. 40	1 349343	21
316.00	TAGLIATUBO 16MM	5 316000	10	349.35	10 DISCHI VELCRO FO 115 GR. 80	10 349350	21
328.00	TAGLIATUBO 28MM	5 328003	10	349.36	25 DISCHI VELCRO FO 115 GR. 80	1 349367	21
332.00	TAGLIATUBO 32MM	5 332000	10	349.40	10 DISCHI VELCRO FO 115 GR.120	10 349404	21
332.35	TAGLIATUBO 35MM TELESCOPICO	5 332352	10	349.41	25 DISCHI VELCRO FO 115 GR.120	1 349411	21
333.00	ROTELLA UNIVERSALE TAGLIATUBI	10 333007	10	349.45	10 DISCHI VELCRO FO 115 GR.240	10 349459	21
334.00	TAGLIATUBO 42MM TELESCOPICO	1 334004	10	349.46	25 DISCHI VELCRO FO 115 GR.240	1 349466	21
334.20	ROTELLA PER ART. 334.00	10 334202	10	349.50	10 DISCHI VELCRO FO 115 GR.ASS	10 349503	21
335.00	PERNO FISSAGGIO 10X6MM	10 335001	13	349.51	25 DISCHI VELCRO FO 115 GR.ASS	1 349510	21
336.00	PERNO FISSAGGIO 12,8X8MM	10 336008	13	349.55	10 DISCHI VELCRO 125 GR. 40	10 349558	20
337.00	PERNO FISSAGGIO 22,2X8MM	10 337005	13	349.56	25 DISCHI VELCRO 125 GR. 40	1 349565	20
338.00	PLATORELLO GOMMA 125MM	10 338002	14	349.60	10 DISCHI VELCRO 125 GR.120	10 349602	20
338.05	PLATORELLO GOMMA 180MM	10 338057	14	349.61	25 DISCHI VELCRO 125 GR.120	1 349619	20
338.08	PLATORELLO GOMMA 180MM SF	10 338088	14	349.65	10 DISCHI VELCRO 125 GR.240	10 349657	20
338.10	PLATORELLO NYLON 100X10MM	10 338101	14	349.66	25 DISCHI VELCRO 125 GR.240	1 349664	20
338.20	PLATORELLO NYLON 115X14MM	10 338200	14	349.70	10 DISCHI VELCRO 125 GR.ASS	10 349701	20
338.22	PLATORELLO NYLON 178X14MM	10 338224	14	349.71	25 DISCHI VELCRO 125 GR.ASS	1 349718	20
338.25	PLATORELLO NYLON 100X10MM SF	10 338255	14	349.73	10 DISCHI VELCRO FO 125 GR. 40	10 349732	21
338.30	PLATORELLO NYLON 115X10MM SF	10 338309	14	349.74	25 DISCHI VELCRO FO 125 GR. 40	1 349749	21
338.35	PLATORELLO NYLON 115X14MM SF	10 338354	14	349.75	10 DISCHI VELCRO FO 125 GR. 80	10 349756	21
338.40	PLATORELLO NYLON 115X16MM SF	10 338408	14	349.76	25 DISCHI VELCRO FO 125 GR. 80	1 349763	21
338.45	PLATORELLO NYLON 125X14MM SF	10 338453	14	349.80	10 DISCHI VELCRO FO 125 GR.120	10 349800	21
338.50	PLATORELLO NYLON 125X16MM SF	10 338507	14	349.81	25 DISCHI VELCRO FO 125 GR.120	1 349817	21
338.55	PLATORELLO NYLON 150X14MM SF	10 338552	14	349.85	10 DISCHI VELCRO FO 125 GR.240	10 349855	21
338.60	PLATORELLO NYLON 150X16MM SF	10 338606	14	349.86	25 DISCHI VELCRO FO 125 GR.240	1 349862	21
338.65	PLATORELLO NYLON 178X14MM SF	10 338651	14	349.90	10 DISCHI VELCRO FO 125 GR.ASS	10 349909	21
338.70	PLATORELLO NYLON 178X16MM SF	10 338705	14	349.91	25 DISCHI VELCRO FO 125 GR.ASS	1 349916	21
338.75	PLATORELLO NYLON 178X14 BIA.SF	10 338750	14	349.95	10 DISCHI VELCRO FO 150 GR. 40	10 349954	21
338.80	PLATORELLO VELCRO 115MM M14	5 338804	14	349.96	10 DISCHI VELCRO FO 150 GR. 80	10 349961	21
338.82	PLATORELLO VELCRO 125MM M14	5 338828	14	349.97	10 DISCHI VELCRO FO 150 GR.120	10 349978	21
338.85	PLATORELLO VELCRO 150MM M14	5 338859	14	349.98	10 DISCHI VELCRO FO 150 GR.240	10 349985	21
339.00	CUFFIA PER LUCIDARE 140MM	10 339009	15	349.99	10 DISCHI VELCRO FO 150 GR.ASS	10 349992	21
339.20	CUFFIA PER LUCIDARE 190MM	10 339207	15	350.00	6 DISCHI TELA 125 GR. 40	10 350004	19
339.22	CUFFIA AGNELLO-VELCRO 115MM	10 339221	15	351.00	6 DISCHI TELA 125 GR. 80	10 351001	19
339.23	CUFFIA AGNELLO-VELCRO 125MM	10 339238	15	352.00	6 DISCHI TELA 125 GR.150	10 352008	19
339.24	CUFFIA AGNELLO-VELCRO 160MM	10 339245	15	353.00	6 DISCHI TELA 125 ASSORTITI	10 353005	19
339.25	DISCO FELTRO 80X10MM	10 339252	15	354.00	10 FOGLI VEL.FO 93X185 GR. 40	5 354002	25
339.26	DISCO FELTRO 125MM VELCRO	10 339269	15	354.03	10 FOGLI VEL.FO 93X185 GR. 80	5 354033	25
339.27	DISCO FELTRO 125X15MM	10 339276	15	354.06	10 FOGLI VEL.FO 93X185 GR.120	5 354064	25
339.28	DISCO FELTRO 150X20MM	10 339283	15	354.09	10 FOGLI VEL.FO 93X185 GR.180	5 354095	25
339.29	PANNO VELCRO LEVIG.DELTA 93MM	10 339290	15	354.12	10 FOGLI VEL.FO 93X185 GR.ASS	5 354125	25
339.30	RUOTA IN TESSUTO 80MM	10 339306	15	354.15	10 FOGLI VEL.FO 93X185 GR. 40	5 354156	25

INDICE NUMERICO: ARTICOLI, QUANTITÀ E CODICI A BARRE

Anteporre al codice EAN il prefisso 8011017

ref.	descrizione	ean	pag.	ref.	descrizione	ean	pag.
354.18	10 FOGLI VEL.FO 93X185 GR. 80	5	354187 25	358.20	DISCO LAMELLARE 115 NYLON 120	10	358208 30
354.21	10 FOGLI VEL.FO 93X185 GR.120	5	354217 25	358.25	DISCO LAMELLARE 180 NYLON 40	10	358253 30
354.24	10 FOGLI VEL.FO 93X185 GR.180	5	354248 25	358.30	DISCO LAMELLARE 180 NYLON 80	10	358307 30
354.27	10 FOGLI VEL.FO 93X185 GR.ASS	5	354279 25	358.35	DISCO LAMELLARE 180 NYLON 120	10	358352 30
354.30	10 FOGLI FORATI 93X230 GR. 40	5	354309 25	358.40	RUOTA LAMELLARE 40X20 GR. 80	10	358406 29
354.33	10 FOGLI FORATI 93X230 GR. 80	5	354330 25	358.50	RUOTA LAMELLARE 50X20 GR. 80	10	358505 29
354.36	10 FOGLI FORATI 93X230 GR.120	5	354361 25	358.60	RUOTA LAMELLARE 60X40 GR. 80	10	358604 29
354.39	10 FOGLI FORATI 93X230 GR.180	5	354392 25	358.80	RUOTA LAMELLARE 80X30 GR. 80	10	358802 29
354.42	10 FOGLI FORATI 93X230 GR.ASS	5	354422 25	358.90	ASSORTIMENTO 40 RUOTE LAM.RI	1	358901 29
354.45	10 FOGLI FORATI 93X230 GR. 40	5	354453 26	359.00	DISCO LAMELLARE 115 FIBRA 80	10	359007 30
354.48	10 FOGLI FORATI 93X230 GR. 80	5	354484 26	359.05	DISCO LAMELLARE 180 FIBRA 80	10	359052 30
354.51	10 FOGLI FORATI 93X230 GR.120	5	354514 26	359.10	DISCO LAMELLARE 115 FIBRA 40	10	359106 30
354.54	10 FOGLI FORATI 93X230 GR.180	5	354545 26	359.15	DISCO LAMELLARE 115 FIBRA 80	10	359151 30
354.57	10 FOGLI FORATI 93X230 GR.ASS	5	354576 26	359.20	DISCO LAMELLARE 115 FIBRA 120	10	359205 30
354.60	10 FOGLI VEL.FO 115X230 GR. 40	5	354606 26	359.25	DISCO LAMELLARE 180 FIBRA 40	10	359250 30
354.63	10 FOGLI VEL.FO 115X230 GR. 80	5	354637 26	359.30	DISCO LAMELLARE 180 FIBRA 80	10	359304 30
354.66	10 FOGLI VEL.FO 115X230 GR.120	5	354668 26	359.35	DISCO LAMELLARE 180 FIBRA 120	10	359359 30
354.69	10 FOGLI VEL.FO 115X230 GR.180	5	354699 26	359.36	2 STICK PASTA PRE-LUCIDATURA	10	359366 16
354.72	10 FOGLI VEL.FO 115X230 GR.ASS	5	354729 26	359.37	2 STICK PASTA LUCIDATURA	10	359373 16
354.75	10 FOGLI FORATI 115X280 GR. 40	5	354750 26	359.38	2 STICK PASTA ASSORTITI	10	359380 16
354.78	10 FOGLI FORATI 115X280 GR. 80	5	354781 26	359.40	RUOTA PANNO ABRASIVO 50X25MM	5	359403 17
354.81	10 FOGLI FORATI 115X280 GR.120	5	354811 26	359.42	RUOTA PANNO ABRASIVO 75X45MM	5	359427 17
354.84	10 FOGLI FORATI 115X280 GR.180	5	354842 26	359.44	RUOTA PANNO ABRASIVO 100X50MM	5	359441 17
354.87	10 FOGLI FORATI 115X280 GR.ASS	5	354873 26	359.46	RUOTA PANNO-TELA ABR. 50X25MM	5	359465 17
355.00	ASSORTIMENTO TELA-CARTA 125MM	10	355009 19	359.48	RUOTA PANNO-TELA ABR. 75X45MM	5	359489 17
355.10	3 NASTRI ABRAS. 400X60 GR. 40	3	355108 27	359.50	RUOTA PANNO-TELA ABR.100X50MM	5	359502 17
355.11	3 NASTRI ABRAS. 400X60 GR. 60	3	355115 27	359.70	RUOTA PANNO ABRASIVO 150X25MM	5	359700 17
355.12	3 NASTRI ABRAS. 400X60 GR. 80	3	355122 27	359.72	RUOTA PANNO-TELA ABR.150X25MM	5	359724 17
355.13	3 NASTRI ABRAS. 400X60 GR.100	3	355139 27	359.82	DISCO IN FIBRE DI NYLON 100MM	5	359823 17
355.14	3 NASTRI ABRAS. 400X60 GR.150	3	355146 27	359.86	DISCO IN FIBRE DI NYLON 115MM	5	359861 17
355.15	3 NASTRI ABRAS. 560X100 GR. 40	2	355153 27	360.00	FRESA MEZZO TONDA 45° 35MM	5	360003 39
355.16	3 NASTRI ABRAS. 560X100 GR. 60	2	355160 27	361.00	FRESA MEZZO TONDA 45° 35MM	5	361000 39
355.17	3 NASTRI ABRAS. 560X100 GR. 80	2	355177 27	362.00	FRESA PROFILO CONCAVO 35MM	5	362007 39
355.18	3 NASTRI ABRAS. 560X100 GR.100	2	355184 27	363.00	FRESA PROFILO CONVESSO 35MM	5	363004 39
355.19	3 NASTRI ABRAS. 560X100 GR.150	2	355191 27	364.00	FRESA CILINDRICA 25MM	5	364001 39
355.20	3 NASTRI ABRAS. 610X100 GR. 40	2	355207 27	364.50	FRESA PROFILO TONDO 25MM	5	364506 39
355.21	3 NASTRI ABRAS. 610X100 GR. 60	2	355214 27	365.00	FRESA CONICA 45° 35MM	5	365008 39
355.22	3 NASTRI ABRAS. 610X100 GR. 80	2	355221 27	366.00	FRESA SCANALARE 35MM	5	366005 39
355.23	3 NASTRI ABRAS. 610X100 GR.100	2	355238 27	367.00	FRESA DOPPIA BATTUTA 30MM	5	367002 39
355.24	3 NASTRI ABRAS. 610X100 GR.150	2	355245 27	368.00	FRESA INTAGLI 30X1,5MM	5	368009 39
355.25	3 NASTRI ABRAS. 620X100 GR. 40	2	355252 27	369.00	FRESA INTAGLI 30X2,5MM	5	369006 39
355.26	3 NASTRI ABRAS. 620X100 GR. 60	2	355269 27	370.00	FRESA A SEGA 45MM	5	370002 39
355.27	3 NASTRI ABRAS. 620X100 GR. 80	2	355276 27	372.00	FRESA A DITO 6MM PER MORTASARE	5	372006 39
355.28	3 NASTRI ABRAS. 620X100 GR.100	2	355283 27	373.00	FRESATRICE UNIVERSALE	1	373003 39
355.29	3 NASTRI ABRAS. 620X100 GR.150	2	355290 27	374.03	PUNTA-FRESA REGOLABILE 3MM	10	374031 39
355.60	6 FOGLI CARTA 230X280 GR. 60	10	355603 22	374.04	PUNTA-FRESA REGOLABILE 4MM	10	374048 39
355.62	6 FOGLI CARTA 230X280 GR.100	10	355627 22	374.05	PUNTA-FRESA REGOLABILE 5MM	10	374055 39
355.64	6 FOGLI CARTA 230X280 GR.150	10	355641 22	374.06	PUNTA-FRESA REGOLABILE 6MM	10	374062 39
355.66	6 FOGLI CARTA 230X280 ASS.TI	10	355665 22	375.00	FRESA SVASARE 6MM	10	375007 40
355.70	6 FOGLI CARTA IMPERM.LE GR.180	10	355702 22	376.00	FRESA SVASARE 12MM	10	376004 40
355.72	6 FOGLI CARTA IMPERM.LE GR.320	10	355726 22	377.00	FRESA SVASARE 16MM	10	377001 40
355.74	6 FOGLI CARTA IMPERM.LE GR.600	10	355740 22	378.00	FRESA SVASARE 19MM	10	378008 40
355.76	6 FOGLI CARTA IMPERM.LE ASS.TI	10	355764 22	379.00	FRESA SVASARE 13MM A OMBRELLO	10	379005 40
355.80	6 FOGLI TELA 230X280 GR. 60	10	355801 23	379.50	FRESA CERNIERA 20MM	10	379500 40
355.82	6 FOGLI TELA 230X280 GR.120	10	355825 23	380.00	FRESA CERNIERA 26MM	10	380001 40
355.84	6 FOGLI TELA 230X280 GR.240	10	355849 23	381.00	FRESA CERNIERA 30MM	10	381008 40
355.86	6 FOGLI TELA 230X280 ASS.TI	10	355863 23	382.00	FRESA CERNIERA 35MM	10	382005 40
355.90	ROTOLO CARTA 5M GR. 50	2	355900 24	383.00	FRESA CERNIERA 38MM	10	383002 40
355.92	ROTOLO CARTA 5M GR. 80	2	355924 24	384.00	FRESA CERNIERA MET.DURO 20MM	5	384009 40
355.94	ROTOLO CARTA 5M GR.120	2	355948 24	384.10	FRESA CERNIERA MET.DURO 30MM	5	384108 40
355.96	ROTOLO CARTA VELCRO 3M GR. 50	2	355962 24	384.20	FRESA CERNIERA MET.DURO 35MM	5	384207 40
355.97	ROTOLO CARTA VELCRO 3M GR. 80	2	355979 24	384.50	MECCCHIA PER LEGNO 6MM	10	384504 41
355.98	ROTOLO CARTA VELCRO 3M GR.120	2	355986 24	385.00	MECCCHIA PER LEGNO 8MM	10	385006 41
356.00	10 FOGLI CARTA 93X230 GR. 50	10	356006 24	386.00	MECCCHIA PER LEGNO 10MM	10	386003 41
356.01	25 FOGLI CARTA 93X230 GR. 50	1	356013 24	387.00	MECCCHIA PER LEGNO 12MM	10	387000 41
356.10	10 FOGLI CARTA 93X230 GR. 80	10	356105 24	388.00	MECCCHIA PER LEGNO 14MM	10	388007 41
356.11	25 FOGLI CARTA 93X230 GR. 80	1	356112 24	389.00	MECCCHIA PER LEGNO 16MM	10	389004 41
356.20	10 FOGLI CARTA 93X230 GR.120	10	356204 24	390.00	MECCCHIA PER LEGNO 18MM	10	390000 41
356.21	25 FOGLI CARTA 93X230 GR.120	1	356211 24	391.00	MECCCHIA PER LEGNO 20MM	10	391007 41
356.30	10 FOGLI CARTA 93X230 ASS.TI	10	356303 24	392.00	MECCCHIA PER LEGNO 22MM	10	392004 41
356.31	25 FOGLI CARTA 93X230 ASS.TI	1	356310 24	392.50	MECCCHIA PER LEGNO 24MM	10	392509 41
357.00	10 FOGLI CARTA 115X280 GR. 50	10	357003 24	393.00	MECCCHIA PER LEGNO 25MM	10	393001 41
357.01	25 FOGLI CARTA 115X280 GR. 50	1	357010 24	393.20	MECCCHIA PER LEGNO 26MM	10	393209 41
357.10	10 FOGLI CARTA 115X280 GR. 80	10	357102 24	393.40	MECCCHIA PER LEGNO 28MM	10	393407 41
357.11	25 FOGLI CARTA 115X280 GR. 80	1	357119 24	393.60	MECCCHIA PER LEGNO 30MM	10	393605 41
357.20	10 FOGLI CARTA 115X280 GR.120	10	357201 24	394.00	MECCCHIA PER LEGNO 32MM	10	394008 41
357.21	25 FOGLI CARTA 115X280 GR.120	1	357218 24	394.20	MECCCHIA PER LEGNO 35MM	10	394206 41
357.30	10 FOGLI CARTA 115X280 ASS.TI	10	357300 24	394.40	MECCCHIA PER LEGNO 38MM	10	394404 41
357.31	25 FOGLI CARTA 115X280 ASS.TI	1	357317 24	394.70	MECCCHIA REGOLABILE 15/45MM	2	394701 41
357.35	3 NASTRI ABRAS. 533X75 GR. 40	2	357355 28	394.80	MECCCHIA REGOLABILE 22/76MM	2	394800 41
357.36	3 NASTRI ABRAS. 533X75 GR. 60	2	357362 28	394.84	PROLUNGA PER MECCCHIE 150MM	5	394848 41
357.37	3 NASTRI ABRAS. 533X75 GR. 80	2	357379 28	394.86	PROLUNGA PER MECCCHIE 300MM	5	394862 41
357.38	3 NASTRI ABRAS. 533X75 GR.100	2	357386 28	395.00	MOLA PER AFFILARE	10	395005 31
357.39	3 NASTRI ABRAS. 533X75 GR.150	2	357393 28	395.20	COTE PER AFFILARE	10	395203 31
357.40	3 NASTRI ABRAS. 410X65 GR. 40	3	357409 28	395.40	COTE PER AFFILARE SF	10	395401 31
357.45	3 NASTRI ABRAS. 410X65 GR. 60	3	357454 28	396.00	SET 100 MOLE/GAMBO 6MM	1	396002 31
357.50	3 NASTRI ABRAS. 410X65 GR. 80	3	357508 28	397.00	SET 45 MOLE/GAMBO 3/6MM	1	397009 31
357.55	3 NASTRI ABRAS. 410X65 GR.100	3	357553 28	397.20	SET 48 MOLE/GAMBO 3MM CILIND.	1	397207 31
357.57	3 NASTRI ABRAS. 410X65 GR.150	3	357577 28	397.30	SET 48 MOLE/GAMBO 3MM ASS.TE	1	397306 31
357.60	3 NASTRI ABRAS. 510X75 GR. 40	2	357607 28	397.60	SET 3 MOLE/GAMBO 3MM AF.CATENE	10	397603 31
357.65	3 NASTRI ABRAS. 510X75 GR. 60	2	357652 28	398.00	SET 5 MOLE/GAMBO 3MM	10	398006 31
357.70	3 NASTRI ABRAS. 510X75 GR. 80	2	357706 28	399.00	SET 5 MOLE/GAMBO 6MM	10	399003 31
357.75	3 NASTRI ABRAS. 510X75 GR.100	2	357751 28	400.00	MOLA ABRASIVA 75X10X13MM A96	10	400006 34
357.77	3 NASTRI ABRAS. 510X75 GR.150	2	357775 28	402.00	MOLA ABRASIVA 75X10X13MM A96	10	402000 34
357.78	3 NASTRI ABRAS. 457X75 GR. 40	2	357782 28	403.00	MOLA ABRASIVA 75X10X13MM C49	10	403007 34
357.79	3 NASTRI ABRAS. 457X75 GR. 60	2	357799 28	404.00	MOLA ABRASIVA 100X12X13MM A96	10	404004 34
357.80	3 NASTRI ABRAS. 457X75 GR. 80	2	357805 28	404.50	MOLA ABRASIVA 125X15X16MM A96	10	404509 34
357.81	3 NASTRI ABRAS. 457X75 GR.100	2	357812 28	405.00	MOLA ABRASIVA 150X20X16MM A96	10	405001 34
357.82	3 NASTRI ABRAS. 457X75 GR.150	2	357829 28	406.00	MOLA FERRO 125X2,5X13MM	10	406008 34
357.96	SMERIGLIATORE ESPANSIONE 45X30	10	357966 29	406.95	MOLA FERRO 115X1,0X22MM SFUSA	10	406954 34
357.98	3 NASTRI PER SMERIGLIATORE	10	357980 29	407.00	MOLA FERRO 115X1,6X22MM	10	407005 34
358.00	DISCO LAMELLARE 115 NYLON 80	10	358000 30	407.05	MOLA FERRO 115X1,6X22MM SFUSA	10	407050 34
358.05	DISCO LAMELLARE 180 NYLON 80	10	358055 30	408.00	MOLA MARMO 125X2,5X13MM	10	408002 34
358.10	DISCO LAMELLARE 115 NYLON 40	10	358109 30	409.00	MOLA MARMO 115X1,6X22MM	10	409009 34
358.15	DISCO LAMELLARE 115 NYLON 80	10	358154 30	409.05	MOLA MARMO 115X1,6X22MM SFUSA	10	409054 34

INDICE NUMERICO: ARTICOLI, QUANTITÀ E CODICI A BARRE

Anteporre al codice EAN il prefisso 8011017

ref.	descrizione	ean	pag.	ref.	descrizione	ean	pag.
413.00	MOLA FERRO 115X3,2X22MM	413006	35	462.50	INSERTO 1,2X7,2 + PHILLIPS N.3	462509	47
413.05	MOLA FERRO 115X3,2X22MM SFUSA	413051	35	463.00	KIT 7 INSERTI ASSORTITI	463001	47
413.50	MOLA MARMO 115X3,2X22MM	413501	35	463.50	KIT 7 INSERTI ASSORTITI TORX	463506	47
413.55	MOLA MARMO 115X3,2X22MM SFUSA	413556	35	464.00	KIT 10 INSERTI ASSORTITI	464008	47
414.00	MOLA FERRO 115X6,4X22MM	414003	35	465.02	PUNTA HSS ATT.ESAGONALE 2MM	465029	88
414.05	MOLA FERRO 115X6,4X22MM SFUSA	414058	35	465.03	PUNTA HSS ATT.ESAGONALE 3MM	465036	88
414.50	MOLA MARMO 115X6,4X22MM	414508	35	465.04	PUNTA HSS ATT.ESAGONALE 4MM	465043	88
414.55	MOLA MARMO 115X6,4X22MM SFUSA	414553	35	465.05	PUNTA HSS ATT.ESAGONALE 5MM	465050	88
418.00	MOLA FERRO 230X3,2X22MM SFUSA	418001	35	466.00	SPAZZOLA CIRC.CONICA 90MM	466002	48
418.10	MOLA MARMO 230X3,2X22MM SFUSA	418100	35	466.01	20 SPAZZOLE CIR.CONICHE 90MM	466019	48
419.60	DISCO DIAMANTATO TURBO 115MM	419602	38	467.00	SPAZZOLA CIRC.CONICA 90MM M14	467009	48
419.65	DISCO DIAMANTATO TURBO 230MM	419657	38	467.01	20 SPAZZOLE CIR.CONICHE 90MM	467016	48
419.70	DISCO DIAMANTATO SEGM.TO 115MM	419701	38	468.00	SPAZZOLA CIRC.CONICA 120MM M14	468006	48
419.75	DISCO DIAMANTATO SEGM.TO 230MM	419756	38	468.01	20 SPAZZOLE CIR.CONICHE 120MM	468013	48
419.80	DISCO DIAMANTATO COR.CON.115MM	419800	38	468.20	SPAZZOLA CIRC.CONICA 150MM M14	468204	48
419.85	DISCO DIAMANTATO COR.CON.230MM	419855	38	468.30	SPAZZOLA CIRC.CONICA 100MM RIT	468303	48
419.90	DISCO PER LEGNO 115MM	419909	38	468.35	SPAZZOLA CIRC.CONICA 120MM RIT	468358	48
419.95	DISCO PER LEGNO 230MM	419954	38	468.40	SPAZZOLA CIRC.CONICA 150MM RIT	468402	48
420.00	LIMA ROTATIVA CILINDRICA	420004	43	468.50	SPAZZOLA CIRCOLARE 40MM	468501	49
422.00	LIMA ROTATIVA CONICA	422008	43	468.51	20 SPAZZOLE CIRCOLARI 40MM	468518	49
424.00	LIMA ROTATIVA CILINDR.BOMBATA	424002	43	469.00	SPAZZOLA CIRCOLARE 50MM	469003	49
426.00	LIMA ROTATIVA SFERICA	426006	43	469.01	20 SPAZZOLE CIRCOLARI 50MM	469010	49
43.034	COLLARE RIDUZIONE 43X34MM	430348	86	470.00	SPAZZOLA CIRCOLARE 75MM	470009	49
43.037	COLLARE RIDUZIONE 43X37MM	430379	86	470.01	20 SPAZZOLE CIRCOLARI 75MM	470016	49
43.038	COLLARE RIDUZIONE 43X38MM	430386	86	470.50	SPAZZOLA CIRCOLARE 75MM D.SP.	470504	49
43.384	COLLARE RIDUZIONE 43X38,4MM	433844	86	475.00	SPAZZOLA CIRCOLARE 100MM	475004	49
430.00	RASPA ROTATIVA CILINDRICA	430003	43	475.01	20 SPAZZOLE CIRCOLARI 100MM	475011	49
432.00	RASPA ROTATIVA CONICA	432007	43	475.50	SPAZZOLA CIRCOLARE 100MM D.SP.	475509	49
434.00	RASPA ROTATIVA SFERICA	434001	43	475.65	SPAZZOLA CIRCOLARE 75MM M.RIT	475653	49
436.00	RASPA ROTATIVA CONICA BOMBATA	436005	43	475.70	SPAZZOLA CIRCOLARE 100MM M.RIT	475707	49
438.00	FRESA ROTATIVA A SVASARE	438009	43	476.00	3 MINI SPAZZOLE ASSORTITE	476001	50
440.00	PUNTA-RASPA 6X90MM	440002	43	477.00	SPAZZOLA PENNELLO 16MM	477008	50
440.20	RASPA ROTAT.CONICA ATT.ESAG.LE	440200	43	477.01	20 SPAZZOLE PENNELLO 16MM	477015	50
440.40	RASPA ROT.CIL.BOMB.ATT.ESAG.LE	440408	43	478.00	SPAZZOLA PENNELLO 25MM	478005	50
445.00	PUNTA-FRESA 6X85MM	445007	43	478.01	20 SPAZZOLE PENNELLO 25MM	478012	50
445.20	LIMA ROTAT.CONICA ATT.ESAG.LE	445205	43	478.20	SPAZZOLA FUNGO 30MM	478203	50
445.30	LIMA ROT.CIL.BOMB.ATT.ESAG.LE	445304	43	478.40	SPAZZOLA FUNGO 40MM	478401	50
446.00	SET 3 MINI FRESE-RASPE	446004	43	478.80	SPAZZOLA SCOVOLO 16MM	478807	50
447.00	SET 6 FRESE-RASPE	447001	43	478.90	SPAZZOLA SCOVOLO 20MM	478906	50
448.00	FRESA-RASPA 10/15MM	448008	44	479.00	SPAZZOLA SCOVOLO 28MM	479002	50
448.10	FRESA-RASPA 15/20MM	448107	44	479.01	20 SPAZZOLE SCOVOLO 28MM	479019	50
448.20	FRESA-RASPA 20/25MM	448206	44	479.10	SPAZZOLA SCOVOLO 38MM	479101	50
449.06	LIMA-RASPA PIATTA 150MM - 6"	449067	44	480.00	SPAZZOLA TAZZA 50MM	480008	51
449.08	LIMA-RASPA PIATTA 200MM - 8"	449081	44	480.01	20 SPAZZOLE TAZZA 50MM	480015	51
449.20	SET 6 LIME ASSORTITE 100MM	449203	44	485.00	SPAZZOLA TAZZA 70MM	485003	51
449.40	2 LIME PER SEGHE CATENA 4,0MM	449401	44	485.01	20 SPAZZOLE TAZZA 70MM	485010	51
449.45	12 LIME PER SEGHE CATENA 4,0MM	449456	44	485.20	SPAZZOLA TAZZA 85MM	485201	51
449.50	2 LIME PER SEGHE CATENA 4,8MM	449500	44	485.21	20 SPAZZOLE TAZZA 85MM	485218	51
449.55	12 LIME PER SEGHE CATENA 4,8MM	449555	44	485.30	SPAZZOLA TAZZA 60MM M14	485300	51
449.60	2 LIME PER SEGHE CATENA 5,6MM	449609	44	485.31	20 SPAZZOLE TAZZA 60MM M14	485317	51
449.65	12 LIME PER SEGHE CATENA 5,6MM	449654	44	485.40	SPAZZOLA TAZZA 85MM M14	485409	51
451.00	FRESA MANUALE A SVASARE	451008	40	485.41	20 SPAZZOLE TAZZA 85MM M14	485416	51
451.10	FRESA SVASARE ATT.ESAG.LE 10MM	451107	40	485.50	SPAZZOLA TAZZA 100MM M14	485508	51
451.20	FRESA SVASARE ATT.ESAG.LE 13MM	451206	40	485.51	10 SPAZZOLE TAZZA 100MM M14	485515	51
451.30	FRESA SVASARE ATT.ESAG.LE 16MM	451305	40	485.60	SPAZZOLA TAZZA 120MM M14	485607	51
452.00	PORTA INSERTI MAGNETICO	452005	45	485.61	5 SPAZZOLE TAZZA 120MM M14	485614	51
452.05	PORTA INSERTI RIL. RAPIDO 60MM	452050	45	485.65	SPAZZOLA TAZZA 150MM M14	485652	51
452.10	PORTA INSERTI ARRESTO PROF.TA'	452104	45	485.70	SPAZZOLA TAZZA 65MM M14 M.RIT	485706	51
452.15	PORTA INSERTI FLESSIBILE 190MM	452159	45	485.75	SPAZZOLA TAZZA 85MM M14 M.RIT	485751	51
452.20	PORTA INSERTI ATTACCO SDS	452203	45	485.76	SPAZZOLA TAZZA 100MM M14 M.RIT	485768	51
452.30	AVVITATORE A SQUADRA 90°	452302	45	485.77	SPAZZOLA TAZZA 120MM M14 M.RIT	485775	51
452.40	2 INSERTI TORX 10	452401	45	485.80	SPAZZOLA CIRCOLARE 75X13MM	485805	49
452.50	2 INSERTI TORX 15	452500	45	486.00	SPAZZOLA CIRCOLARE 100X13MM	486000	49
452.60	2 INSERTI TORX 20	452609	45	487.00	SPAZZOLA CIRCOLARE 120X16MM	487007	49
452.70	2 INSERTI TORX 25	452708	45	488.00	SPAZZOLA CIRCOLARE 150X16MM	488004	49
452.80	2 INSERTI TORX 30	452807	45	489.00	SPAZZOLA CIRC.RE 200X20X20MM	489001	49
452.90	2 INSERTI TORX 40	452906	45	489.50	SPAZZOLA CIRC.RE 200X40X20MM	489506	49
452.92	2 INSERTI TORX 10 TITANIO	452920	45	490.00	SPAZZOLA OTTONE CIRC.RE 75MM	490007	48
452.93	2 INSERTI TORX 15 TITANIO	452937	45	495.00	SPAZZOLA OTTONE TAZZA 50MM	495002	48
452.94	2 INSERTI TORX 20 TITANIO	452944	45	496.00	ASSORTIMENTO 40 SPAZZOLE	496009	53
452.95	2 INSERTI TORX 25 TITANIO	452951	45	496.50	ASSORTIMENTO 30 SPAZZOLE NYLON	496504	53
452.96	2 INSERTI TORX 30 TITANIO	452968	45	496.82	SPAZZOLA A MANO MINI - ACCIAIO	496825	55
452.97	2 INSERTI TORX 40 TITANIO	452975	45	496.84	SPAZZOLA A MANO MINI - INOX	496849	55
453.00	2 INSERTI CAVA ESAG.LE 2MM	453002	46	496.85	SPAZZOLA A MANO MINI - OTTONE	496912	55
453.10	2 INSERTI CAVA ESAG.LE 2,5MM	453101	46	496.88	SPAZZOLA A MANO MINI - NYLON	496887	55
453.20	2 INSERTI CAVA ESAG.LE 3MM	453200	46	496.90	ASSORTIMENTO 24 SPAZZOLE MANO	496900	53
453.30	2 INSERTI CAVA ESAG.LE 4MM	453309	46	496.93	SPAZZOLA A MANO - NYLON	496931	54
453.40	2 INSERTI CAVA ESAG.LE 5MM	453408	46	496.96	SPAZZOLA A MANO - OTTONE	496962	54
453.50	2 INSERTI CAVA ESAG.LE 6MM	453507	46	496.99	SPAZZOLA A MANO - INOX	496993	54
454.00	2 INSERTI PHILLIPS N.1	454009	46	497.00	SPAZZOLA A MANO - ACCIAIO	497006	54
455.00	2 INSERTI PHILLIPS N.2	455006	46	497.02	KIT 5 SPAZZOLE ACCIAIO	497020	56
456.00	2 INSERTI PHILLIPS N.3	456003	46	497.04	KIT 4 SPAZZOLE ACCIAIO	497044	56
456.20	INSERTO PHILLIPS N.4	456201	46	497.05	SPAZZOLA NYLON CIRC. 75 GR. 80	497051	52
456.50	2 INSERTI PHILLIPS 1 TITANIO	456508	46	497.10	SPAZZOLA NYLON CIRC. 75 GR.150	497105	52
456.52	2 INSERTI PHILLIPS 2 TITANIO	456522	46	497.15	SPAZZOLA NYLON CIRC.100 GR. 80	497150	52
456.54	2 INSERTI PHILLIPS 3 TITANIO	456546	46	497.20	SPAZZOLA NYLON CIRC.100 GR.150	497204	52
457.00	2 INSERTI TAGLIO 0,8X4MM	457000	46	497.25	SPAZZOLA NYLON TAZZA 50 GR. 80	497259	52
458.00	2 INSERTI TAGLIO 0,8X5MM	458007	46	497.30	SPAZZOLA NYLON TAZZA 50 GR.150	497303	52
459.00	2 INSERTI TAGLIO 1,0X6MM	459004	46	497.35	SPAZZOLA NYLON TAZZA 70 GR. 80	497358	52
459.20	2 INSERTI TAGLIO 1,2X7,2MM	459202	46	497.40	SPAZZOLA NYLON TAZZA 70 GR.150	497402	52
459.40	2 INSERTI TAGLIO 1,6X8MM	459400	46	497.45	SPAZZOLA NYLON PEN. 25 GR. 80	497457	52
459.50	2 INSERTI TAGLIO 0,8X4 TITANIO	459509	46	497.50	SPAZZOLA NYLON PEN. 25 GR.150	497501	52
459.52	2 INSERTI TAGLIO 0,8X5 TITANIO	459523	46	497.55	SPAZZOLA NYLON VENT.100 GR. 80	497556	52
459.54	2 INSERTI TAGLIO 1,0X6 TITANIO	459547	46	497.60	SPAZZOLA NYLON VENT.100 GR.150	497600	52
459.90	2 INSERTI POZIDRIV N.0	459905	47	498.00	OCCHIALI SALDATURA CE	498003	58
460.00	2 INSERTI POZIDRIV N.1	460000	47	498.50	OCCHIALI SALDATURA D.LENTE CE	498508	58
460.10	2 INSERTI POZIDRIV N.2	460109	47	498.60	OCCHIALI SALDATURA D.LENTE CE	498607	58
460.20	2 INSERTI POZIDRIV N.3	460208	47	50.010	SUPPORTO PER TRAPANI 43MM	500102	86
460.30	INSERTO POZIDRIV N.4	460307	47	50.020	SUPPORTO PER TRAPANI 43MM	500201	86
460.50	2 INSERTI POZIDRIV N.0 TITANIO	460505	47	50.030	SUPPORTO PER TRAPANI 60MM	500300	86
460.52	2 INSERTI POZIDRIV N.1 TITANIO	460529	47	50.040	SUPPORTO PER TRAPANI 60MM	500409	86
460.54	2 INSERTI POZIDRIV N.2 TITANIO	460543	47	50.060	SUPPORTO SMERIGLIATRICE 230MM	500607	85
460.56	2 INSERTI POZIDRIV N.3 TITANIO	460567	47	50.080	SUPPORTO SMERIGLIATRICE 230MM	500805	85
461.00	INSERTO 0,8X4 + PHILLIPS N.1	461007	47	50.090	SUPPORTO SMERIGLIATRICE 115MM	500904	85
462.00	INSERTO 0,8X5 + PHILLIPS N.2	462004	47	500.00	OCCHIALI PROTEZIONE CE	500003	58

INDICE NUMERICO: ARTICOLI, QUANTITÀ E CODICI A BARRE

Anteporre al codice EAN il prefisso 8011017

ref.	descrizione	☐	ean	pag.	ref.	descrizione	☐	ean	pag.
500.25	OCCHIALI PROTEZIONE CE	1	500256	58	600.00	12 STICK COLLA 7X100MM	10	600000	80
500.35	OCCHIALI PROTEZIONE CE	1	500355	58	600.20	12 STICK COLLA 11X100MM	10	600208	80
501.00	OCCHIALI PROTEZIONE	5	501000	58	601.00	GRAFFATRICE	1	601007	67
501.20	OCCHIALI PROTEZIONE CE	1	501208	58	604.00	GRAFFATRICE IN METALLO REG.LE	1	604008	67
501.40	OCCHIALI PROTEZIONE CE	1	501406	58	607.30	5000 PUNTI 6MM	5	607306	67
501.60	OCCHIALI PROTEZIONE CE	1	501604	58	607.35	1000 PUNTI 6MM	10	607351	67
502.00	5 MASCHERE PROTETTIVE	10	502007	59	607.40	5000 PUNTI 8MM	5	607405	67
502.50	50 MASCHERE PROTETTIVE	1	502502	59	607.45	1000 PUNTI 8MM	10	607450	67
502.60	2 MASCHERE PROTETTIVE CE	10	502601	59	607.50	5000 PUNTI 10MM	5	607504	67
502.70	2 MASCHERE PROTETTIVE CE	5	502700	59	607.55	1000 PUNTI 10MM	10	607559	67
503.00	MASCHERA PROTETTIVA RINFORZATA	10	503004	59	607.60	5000 PUNTI 12MM	5	607603	67
504.00	RESPIRATORE + FILTRO ANTIPOLV.	5	504001	59	607.65	1000 PUNTI 12MM	10	607658	67
504.20	FILTRO ANTIPOLVERE	5	504209	59	607.70	5000 PUNTI 14MM	5	607702	67
504.40	FILTRO CHIMICO	5	504407	59	607.75	1000 PUNTI 14MM	10	607757	67
504.50	RESPIRATORE + 1 FILTRO A1 CE	1	504506	59	611.10	FLESSOMETRO 3M - NASTRO 16MM	12	611105	68
504.55	FILTRO A1 PER RESP.RE 504.50	2	504551	59	611.20	FLESSOMETRO 5M - NASTRO 19MM	6	611204	68
504.58	FILTRO P3 PER RESP.RE 504.50	2	504582	59	611.25	12 FLESSOMETRI 5M	1	611259	68
504.70	RESPIRATORE + 2 FILTRI A1 CE	1	504704	60	611.30	FLESSOMETRO 8M - NASTRO 25MM	4	611303	68
504.75	FILTRO A1 PER RESP.RE 504.70	2	504759	60	620.00	3 BOCCOLE ARRESTO 6-8-10MM	10	620008	70
504.78	FILTRO P3 PER RESP.RE 504.70	2	504780	60	620.10	BOCCOLA ARRESTO 12MM	10	620107	70
505.00	CUFFIA ANTIRUMORE	5	505008	60	620.20	BOCCOLA ARRESTO 14MM	10	620206	70
505.20	CUFFIA ANTIRUMORE CE	1	505206	60	624.00	PIALLA IN LEGNO 36MM	1	624006	66
505.40	CUFFIA ANTIRUMORE PROF.LE CE	1	505404	60	624.10	LAMA ACCIAIO 36MM PER 624.00	1	624105	66
505.50	KIT ANTI-INFORTUNISTICA 4 PCS	1	505503	60	625.00	PIALLA IN LEGNO 45MM	1	625003	66
505.80	3 PAIA TAPPI AURICOLARI CE	10	505800	60	625.10	LAMA ACCIAIO 45MM PER 625.00	1	625102	66
505.83	5 PAIA TAPPI AUR.DOP.STRATO CE	10	505831	60	626.00	PIALLA IN LEGNO 48MM	1	626000	66
505.86	1 PAIO TAPPI AUR.CORDONCINO CE	10	505862	60	626.10	LAMA ACCIAIO 48MM PER 626.00	1	626109	66
506.10	50 GUANTI M NITRILE HD CE	1	506104	61	628.00	PIALLA LEGNO SPONDERUOLA 24MM	1	628004	66
506.11	50 GUANTI L NITRILE HD CE	1	506111	61	628.10	LAMA ACCIAIO 24MM PER 628.00	1	628103	66
506.12	50 GUANTI XL NITRILE HD CE	1	506128	61	629.00	PIALLA LEGNO SPONDERUOLA 27MM	1	629001	66
506.15	100 GUANTI M NITRILE CE	1	506159	61	629.10	LAMA ACCIAIO 27MM PER 629.00	1	629100	66
506.16	100 GUANTI L NITRILE CE	1	506166	61	629.85	2 LAME PIALLETTO 75,5X5,5X1,1	5	629858	66
506.17	100 GUANTI XL NITRILE CE	1	506173	61	629.87	2 LAME PIALLETTO 80,5X5,9X1,1	5	629872	66
506.50	GINOCCHIERE IN GOMMA	1	506500	61	629.89	2 LAME PIALLETTO 82,0X5,5X1,1	5	629896	66
506.60	ELMETTO PROTETTIVO CE	1	506609	61	629.93	2 LAME PIALLETTO 102X5,5X1,1	5	629933	66
507.00	MISCELATORE 80X400MM	5	507002	62	630.03	PUNTA LEGNO 3MM	10	630038	90
508.00	MISCELATORE 100X500MM	2	508009	62	630.04	PUNTA LEGNO 4MM	10	630045	90
509.00	MISCELATORE 120X600MM	2	509006	62	630.05	PUNTA LEGNO 5MM	10	630052	90
509.40	MISCELATORE 130X600MM	2	509402	62	630.06	PUNTA LEGNO 6MM	10	630069	90
510.00	MISCELATORE 60X350MM	10	510002	62	630.07	PUNTA LEGNO 7MM	10	630076	90
511.00	MISCELATORE 60X400MM	5	511009	62	630.08	PUNTA LEGNO 8MM	10	630083	90
512.00	MISCELATORE 80X400MM	5	512006	62	630.09	PUNTA LEGNO 9MM	10	630090	90
513.00	MISCELATORE 100X600MM	2	513003	62	630.10	PUNTA LEGNO 10MM	10	630106	90
514.00	MISCELATORE 120X600MM	2	514000	62	630.11	PUNTA LEGNO 11MM	10	630113	90
514.10	MISCELATORE 125X600MM D.ELICA	2	514109	62	630.12	PUNTA LEGNO 12MM	10	630120	90
550.00	FLESSIBILE 90CM	1	550008	79	630.13	PUNTA LEGNO 13MM	10	630137	90
550.06	MANDRINO 6MM PER FLESSIBILE	1	550060	79	630.14	PUNTA LEGNO 14MM	10	630144	90
555.00	FLESSIBILE 130CM	1	555003	79	649.00	MATTITA PER FALEGNAME 180MM	144	009407	69
555.08	MANDRINO 8MM PER FLESSIBILE	1	555089	79	649.06	6 MATTITE PER FALEGNAME 180MM	5	649061	69
560.00	FLESSIBILE 130CM PROFESSIONALE	1	560007	79	650.00	MORSETTO PER SPINATURA	1	650005	69
565.00	RACCOGLI POLVERE 4/10MM	10	565002	87	655.00	100 TASSELLI LEGNO 6X30MM	10	655000	69
566.00	COLTELLO ANTINFORTUNISTICA	4	566009	63	655.05	1000 TASSELLI LEGNO 6X30MM	1	655055	69
566.05	COLTELLO PROF.LE + 5 LAME	4	566054	63	660.00	60 TASSELLI LEGNO 8X35MM	10	660004	69
566.11	CUTTER AUTOMATICO + 5 LAME	2	566115	63	660.05	1000 TASSELLI LEGNO 8X35MM	1	660059	69
566.12	CUTTER LAMA 25MM GUIDA METALLO	12	566122	63	665.00	40 TASSELLI LEGNO 10X40MM	10	665009	69
566.14	CUTTER LAMA 9MM G.META.3 LAME	24	566146	63	665.05	1000 TASSELLI LEGNO 10X40MM	1	665054	69
566.16	CUTTER LAMA 18MM G.META.3 LAME	24	566160	63	666.00	30 TASSELLI LEGNO 12X40MM	10	666006	69
566.17	CUTTER LAMA 9MM AUTO + 3 LAME	12	566177	63	666.05	500 TASSELLI LEGNO 12X40MM	1	666051	69
566.18	CUTTER LAMA 18MM AUTO + 3 LAME	12	566184	63	668.00	100 ASTE LEGNO 6X1000MM	1	668000	69
566.20	CUTTER LAMA 9MM CORPO METALLO	24	566207	63	668.10	100 ASTE LEGNO 8X1000MM	1	668109	69
566.23	CUTTER LAMA 9MM CORPO ABS	24	566238	63	668.20	100 ASTE LEGNO 10X1000MM	1	668208	69
566.25	CUTTER LAMA 9MM GUIDA METALLO	24	566252	63	668.30	50 ASTE LEGNO 12X1000MM	1	668307	69
566.30	CUTTER LAMA 9MM CORPO ABS TR.	24	566306	64	668.40	40 ASTE LEGNO 14X1000MM	1	668406	69
566.40	CUTTER LAMA 18MM CORPO ABS TR.	24	566405	64	668.50	40 ASTE LEGNO 16X1000MM	1	668505	69
566.50	CUTTER LAMA 18MM GUIDA METALLO	24	566504	64	669.00	50 LAMELLE LEGNO TIPO 0	10	669007	70
566.60	CUTTER LAMA 18MM GUIDA METALLO	24	566603	64	669.05	1000 LAMELLE LEGNO TIPO 0	1	669052	70
567.00	RASCHETTO CON LAMA RETRAIBILE	24	567006	64	669.10	50 LAMELLE LEGNO TIPO 10	10	669106	70
568.00	5 LAME A TRAPEZIO PICCOLO	12	568003	64	669.15	1000 LAMELLE LEGNO TIPO 10	1	669151	70
568.10	5 LAME A TRAPEZIO GRANDE	12	568102	64	669.20	50 LAMELLE LEGNO TIPO 20	10	669205	70
568.20	5 LAME AD UNCINO	12	568201	64	669.25	1000 LAMELLE LEGNO TIPO 20	1	669250	70
568.30	10 LAME PER CUTTER 9MM	12	568300	64	670.00	4 SPINE A CENTRARE 6MM	10	670003	70
568.40	10 LAME PER CUTTER 18MM	12	568409	64	675.00	4 SPINE A CENTRARE 8MM	10	675008	70
568.50	5 LAME PER CUTTER 25MM	12	568508	64	680.00	4 SPINE A CENTRARE 10MM	10	680002	70
569.00	TAGLIAVETRO	5	569000	64	680.10	4 SPINE A CENTRARE 12MM	10	680101	70
570.00	SET 5 SGORBIE PER LEGNO	2	570006	65	680.20	2 SPINE A CENTRARE 14MM	10	680200	70
572.00	SET 6 SGORBIE PER LEGNO	2	572000	65	681.00	KIT ASSEMBLAGGIO 6MM	5	681009	70
575.00	SCALPELLO PER FALEGNAME 6MM	5	575001	65	682.00	KIT ASSEMBLAGGIO 8MM	5	682006	70
576.00	SCALPELLO PER FALEGNAME 8MM	5	576008	65	683.00	KIT ASSEMBLAGGIO 10MM	5	683003	70
577.00	SCALPELLO PER FALEGNAME 10MM	5	577005	65	684.00	3 LAME B.& D. D.GROSSI HSS	10	684000	71
578.00	SCALPELLO PER FALEGNAME 12MM	5	578002	65	685.00	3 LAME B.& D. D.MEDI HSS	10	685007	71
579.00	SCALPELLO PER FALEGNAME 14MM	5	579009	65	686.00	3 LAME B.& D. D.FINI HSS	10	686004	71
580.00	SCALPELLO PER FALEGNAME 16MM	5	580005	65	686.50	3 LAME B.& D. D.MEDI HSS 80MM	10	686509	71
581.00	SCALPELLO PER FALEGNAME 18MM	5	581002	65	687.00	3 LAME B.& D. D.GROSSI CV	10	687001	71
582.00	SCALPELLO PER FALEGNAME 20MM	5	582009	65	688.00	3 LAME B.& D. D.MEDI CV	10	688008	71
583.00	SCALPELLO PER FALEGNAME 26MM	5	583006	65	689.00	3 LAME B.& D. D.FINI CV	10	689005	71
584.00	SCALPELLO PER FALEGNAME 30MM	5	584003	65	689.10	3 LAME B.& D. D.GROSSI CV RET	10	689104	71
585.00	SCALPELLO PER FALEGNAME 32MM	5	585000	65	689.20	3 LAME B.& D. D.MEDI CV RET	10	689203	71
586.00	SCALPELLO PER FALEGNAME 40MM	5	586007	65	689.50	3 LAME B.& D. D.MEDI CV 100MM	10	689500	71
590.00	TRIVELLINO PER LEGNO 2MM	10	590004	65	694.00	3 LAME BOSCH D.GROSSI HSS	10	694009	72
591.00	TRIVELLINO PER LEGNO 3MM	10	591001	65	695.00	3 LAME BOSCH D.MEDI HSS	10	695006	72
592.00	TRIVELLINO PER LEGNO 4MM	10	592008	65	696.00	3 LAME BOSCH D.FINI HSS	10	696003	72
593.00	TRIVELLINO PER LEGNO 5MM	10	593005	65	696.50	3 LAME BOSCH D.MEDI HSS 80MM	10	696508	72
594.00	TRIVELLINO PER LEGNO 6MM	10	594002	65	697.00	3 LAME BOSCH D.GROSSI CV	10	697000	72
595.00	TRIVELLINO PER LEGNO 8MM	10	595009	65	698.00	3 LAME BOSCH D.MEDI CV	10	698007	72
597.00	TRIVELLINI PER LEGNO 2-3-4MM	10	597003	65	699.00	3 LAME BOSCH D.FINI CV	10	699004	72
598.00	LEVA-CHIODI 190MM	10	598000	66	699.10	3 LAME BOSCH D.GROSSI CV RET	10	699103	72
598.50	PENNA PER INCISIONI SU METALLO	5	598505	80	699.20	3 LAME BOSCH D.MEDI CV RET	10	699202	72
599.00	PISTOLA TERMOCOLLANTE 20W-7MM	1	599007	80	699.50	3 LAME BOSCH D.MEDI CV 100MM	10	699509	72
599.20	PISTOLA TERMOCOLLANTE 40W-11MM	1	599205	80	699.60	2 LAME BOSCH D.MEDI CV 220MM	10	699399	72
60.043	COLLARE RIDUZIONE 60X43MM	1	600437	86	704.00	3 LAME BOSCH D.GROSSI HSS	10	704005	73
60.046	COLLARE RIDUZIONE 60X46MM	1	600468	86	705.00	3 LAME BOSCH D.MEDI HSS	10	705002	73
60.050	COLLARE RIDUZIONE 60X50MM	1	600505	86	706.00	3 LAME BOSCH D.FINI HSS	10	706009	73
60.053	COLLARE RIDUZIONE 60X53MM	1	600536	86	707.00	3 LAME BOSCH D.GROSSI CV	10	707006	73
60.054	COLLARE RIDUZIONE 60X54MM	1	600543	86	708.00	3 LAME BOSCH D.MEDI CV	10	708003	73
60.056	COLLARE RIDUZIONE 60X56MM	1	600567	86	714.00	3 LAME MAKITA D.GROSSI HSS	10	714004	73

INDICE NUMERICO: ARTICOLI, QUANTITÀ E CODICI A BARRE

Anteporre al codice EAN il prefisso 8011017

ref.	descrizione	ean	pag.	ref.	descrizione	ean	pag.
715.00	3 LAME MAKITA D.MEDI HSS	715001	73	835.00	FRESA CONICA HSS 0/25MM	835006	12
716.00	3 LAME MAKITA D.FINI HSS	716008	73	835.50	FRESA CONICA HSS 6/32MM	835501	12
717.00	3 LAME MAKITA D.GROSSI CV	717005	73	835.60	FRESA CONICA HSS 6/45MM	835600	12
718.00	3 LAME MAKITA D.MEDI CV	718002	73	840.00	SVASATORE HSS 12MM	840000	12
719.00	3 LAME MAKITA D.FINI CV	719009	73	845.00	SVASATORE HSS 16MM	845005	12
720.00	3 LAME B.& D. D.MEDI CV SAGOM.	720005	71	850.00	SVASATORE HSS 20MM	850009	12
720.50	2 LAME B&D D.DENT. CV 115MM	720500	71	880.00	MOLA AD ACQUA 100X20X16MM	880006	80
720.90	KIT 10 LAME B&D ASSORTITE	720906	71	882.00	MOLA 100X20X16 PER ART.880.00	882000	80
721.00	3 LAME BOSCH D.MEDI CV SAGOM.	721002	72	890.00	POMPA PER LIQUIDI	890005	80
721.50	2 LAME BOSCH D.DENT. CV 115MM	721507	72	921.00	TRAPANO A MANO 6MM	921006	81
721.90	KIT 10 LAME BOSCH ASSORTITE	721903	72	924.00	TRAPANO A MANO 8MM	924007	81
722.00	3 LAME MAKITA D.MEDI CV SAGOM.	722009	73	928.00	TRAPANO A MANO 13MM	928005	81
724.00	LAMA B.& D. METALLO DURO	724003	71	930.00	MANDRINO PER TRAPANO MANO 6MM	930008	81
725.00	LAMA BOSCH METALLO DURO	725000	72	932.00	MANDRINO PER TRAPANO MANO 8MM	932002	81
728.00	PUNTA PER VETRO 3MM	728001	87	936.00	MANDRINO PER TRAPANO MANO 13MM	936000	81
728.10	PUNTA PER VETRO 4MM	728100	87	946.00	8 CHIAVI VITI ESAGONALI	946009	81
728.20	PUNTA PER VETRO 5MM	728209	87	946.50	10 CHIAVI VITI ESAGONALI	946504	81
728.30	PUNTA PER VETRO 6MM	728308	87	947.00	8 CHIAVI VITI TORX	947006	81
728.40	PUNTA PER VETRO 8MM	728407	87	948.00	STRETTOIO PER FALEGNAME 150MM	948003	82
728.50	PUNTA PER VETRO 10MM	728506	87	948.10	STRETTOIO PER FALEGNAME 200MM	948102	82
728.60	PUNTA PER VETRO 12MM	728605	87	948.20	STRETTOIO PER FALEGNAME 250MM	948201	82
728.80	PUNTA PER VETRO 3MM ATT.ESAG.	728803	87	948.30	STRETTOIO PER FALEGNAME 300MM	948300	82
728.81	PUNTA PER VETRO 4MM ATT.ESAG.	728810	87	948.40	STRETTOIO PER FALEGNAME 400MM	948409	82
728.82	PUNTA PER VETRO 5MM ATT.ESAG.	728827	87	948.50	STRETTOIO PER FALEGNAME 500MM	948508	82
728.83	PUNTA PER VETRO 6MM ATT.ESAG.	728834	87	948.60	STRETTOIO PER FALEGNAME 600MM	948607	82
728.85	PUNTA PER VETRO 8MM ATT.ESAG.	728858	87	948.65	STRETTOIO PER FALEGNAME 700MM	948652	82
728.87	PUNTA PER VETRO 10MM ATT.ESAG.	728872	87	948.70	STRETTOIO PER FALEGNAME 800MM	948706	82
728.89	PUNTA PER VETRO 12MM ATT.ESAG.	728896	87	948.80	STRETTOIO PER FALEGNAME 1000MM	948805	82
730.00	SEGA A TAZZA 25/62MM 25MM	730004	74	948.82	STRETTOIO PER FALEGNAME 1200MM	948829	82
732.00	SEGA A TAZZA 25/62MM 50MM	732008	74	948.84	STRETTOIO PER FALEGNAME 1500MM	948843	82
735.00	SEGA A TAZZA 60/95MM 40MM	735009	74	948.86	STRETTOIO PER FALEGNAME 2000MM	948867	82
740.00	SEGA CIRC. 125X20 D. 24 C.V.	740003	76	948.88	STRETTOIO PER FALEGNAME 2500MM	948881	82
745.00	SEGA CIRC. 125X20 D. 80 C.V.	745008	76	948.90	STRETTOIO PER FALEGNAME 3000MM	948904	82
750.00	SEGA CIRC. 150X20 D. 24 C.V.	750002	76	948.93	STRETTOIO AUTOBLOCCANTE 150MM	948935	82
755.00	SEGA CIRC. 150X20 D. 80 C.V.	755007	76	948.95	STRETTOIO AUTOBLOCCANTE 300MM	948959	82
756.02	SEGA CIRC. 125X20 D. 18 M.DURO	756028	76	948.97	STRETTOIO AUTOBLOCCANTE 450MM	948973	82
756.06	SEGA CIRC. 140X20 D. 18 M.DURO	756066	76	949.00	MORSETTO SERRAGGIO "C" 80X65	949000	82
756.10	SEGA CIRC. 150X20 D. 20 M.DURO	756103	76	949.10	MORSETTO SERRAGGIO "C" 105X75	949109	82
756.12	SEGA CIRC. 150X20 D. 34 M.DURO	756127	76	949.20	MORSETTO SERRAGGIO "C" 160X75	949208	82
756.14	SEGA CIRC. 160X20 D. 24 M.DURO	756141	76	949.50	MORSETTO REGOLAZ. RAPIDA 50MM	949505	83
756.16	SEGA CIRC. 160X20 D. 36 M.DURO	756165	76	949.60	MORSETTO REGOLAZ. RAPIDA 75MM	949604	83
756.18	SEGA CIRC. 170X30 D. 18 M.DURO	756189	76	949.70	MORSETTO REGOLAZ. RAPIDA 100MM	949703	83
756.20	SEGA CIRC. 170X30 D. 36 M.DURO	756202	76	951.00	MORSETTO 25MM	951003	83
756.22	SEGA CIRC. 180X30 D. 22 M.DURO	756226	76	952.00	MORSETTO 50MM	952000	83
756.24	SEGA CIRC. 180X30 D. 36 M.DURO	756240	76	953.00	MORSETTO 75MM	953007	83
756.26	SEGA CIRC. 180X30 D. 52 M.DURO	756264	76	954.00	MORSETTO DA BANCO 70MM	954004	83
756.28	SEGA CIRC. 190X30 D. 30 M.DURO	756288	76	955.00	MORSETTO AD ANGOLO 90°	955001	83
756.30	SEGA CIRC. 190X30 D. 42 M.DURO	756301	76	956.00	MORSETTO AD ANGOLO PER CORNICI	956008	83
756.32	SEGA CIRC. 200X30 D. 42 M.DURO	756325	76	957.00	MORSETTO SERRAGGIO A NASTRO 4M	957005	84
756.34	SEGA CIRC. 200X30 D. 60 M.DURO	756349	76	957.50	MORSETTO A CRICCO 50MM	957500	84
756.36	SEGA CIRC. 210X30 D. 20 M.DURO	756363	76	957.70	MORSETTO A CRICCO 70MM	957708	84
756.38	SEGA CIRC. 210X30 D. 30 M.DURO	756387	76	958.00	4 MINI MORSETTI A MOLLA 18MM	958002	84
756.40	SEGA CIRC. 210X30 D. 42 M.DURO	756400	76	958.05	MORSETTO A MOLLA 30MM	958057	84
756.42	SEGA CIRC. 230X30 D. 20 M.DURO	756424	76	958.07	MORSETTO A MOLLA 40MM	958071	84
756.44	SEGA CIRC. 230X30 D. 34 M.DURO	756448	76	958.10	MORSETTO A MOLLA 60MM	958101	84
756.46	SEGA CIRC. 230X30 D. 40 M.DURO	756462	76	958.14	MORSETTO A MOLLA 70MM	958149	84
756.48	SEGA CIRC. 250X30 D. 24 M.DURO	756486	76	960.00	SUPPORTO ORIENTAB.TRAPANO 43MM	960005	85
756.50	SEGA CIRC. 250X30 D. 48 M.DURO	756509	76	965.00	TORNO DA BANCO 43MM	965000	85
756.52	SEGA CIRC. 250X30 D. 60 M.DURO	756523	76	970.00	SUPPORTO PER FRESARE 43MM	970004	85
756.54	SEGA CIRC. 300X30 D. 48 M.DURO	756547	76	972.00	GUIDA REGOLABILE TRAPANO 43MM	972008	85
756.56	SEGA CIRC. 300X30 D. 72 M.DURO	756561	76	A96/C49	MOLE ABRASIVE		36
756.58	SEGA CIRC. 300X30 D. 96 M.DURO	756585	76	C48/C48	BASTONCINI RAVVIVAMOLE		37
756.60	SEGA CIRC. 350X30 D. 84 M.DURO	756608	76	DG/DG	PIETRE DOPPIA GRANA		37
756.62	SEGA CIRC. 350X30 D.108 M.DURO	756622	76	ESPO.S1	ESPO DA BANCO SPAZZOLE 134 PZ	087450	57
760.00	MANDRINO AUTOSERRANTE 10MM	760001	77	ESPO.S2	ESPO DA BANCO SPAZZOLE 94 PZ	087702	57
762.00	MANDRINO AUTOSERRANTE 10MM	762005	77	FC.01	FOGLI CARTA 230X280 GR. 40	100	083346
764.00	MANDRINO AUTOSERRANTE 13MM	764009	77	FC.03	FOGLI CARTA 230X280 GR. 60	100	083353
766.00	MANDRINO AUTOSERRANTE 10MM	766003	77	FC.04	FOGLI CARTA 230X280 GR. 80	100	083360
768.00	MANDRINO AUTOSERRANTE 13MM	768007	77	FC.05	FOGLI CARTA 230X280 GR.100	100	083377
773.00	MANDRINO AUTOSERRANTE 10MM	773001	77	FC.06	FOGLI CARTA 230X280 GR.120	100	083384
774.00	MANDRINO AUTOSERRANTE 10MM	774008	77	FC.07	FOGLI CARTA 230X280 GR.150	100	083391
774.50	MANDRINO AUTOSERRANTE 13MM	774503	77	FC.08	FOGLI CARTA 230X280 GR.180	100	083407
775.00	MANDRINO AUTOSERRANTE 10MM	775005	77	LQU/LTR	LIME ABRASIVE	10	37
775.50	MANDRINO AUTOSERRANTE 13MM	775500	77	MA/MN	MOLE/GAMBO	10	32
775.51	MANDRINO AUTOSERRANTE 13MM-SDS	775517	77	PG32A	KIT 32 INSERTI ASSORTITI	1	071046
775.60	MANDRINO AUTOSERRANTE 13MM	775609	77	RC.01	ROTOLO CARTA 120X50YDS GR. 40	1	085159
775.61	MANDRINO AUTOSERRANTE 13MM-SDS	775616	77	RC.03	ROTOLO CARTA 120X50YDS GR. 60	1	085166
780.00	MANDRINO CREMAGLIERA 10MM	780009	78	RC.04	ROTOLO CARTA 120X50YDS GR. 80	1	085173
781.00	MANDRINO CREMAGLIERA 13MM	781006	78	RC.05	ROTOLO CARTA 120X50YDS GR.100	1	085180
783.00	MANDRINO CREMAGLIERA 10MM	783000	78	RC.06	ROTOLO CARTA 120X50YDS GR.120	1	085197
784.00	MANDRINO CREMAGLIERA 13MM	784007	78	RC.07	ROTOLO CARTA 120X50YDS GR.150	1	085203
786.00	MANDRINO CREMAGLIERA 10MM	786001	78	RC.08	ROTOLO CARTA 120X50YDS GR.180	1	085210
787.00	MANDRINO CREMAGLIERA 13MM	787008	78	RC.09	ROTOLO CARTA 120X50YDS GR.240	1	085227
787.01	MANDRINO CREMAGLIERA 13MM-SDS	787015	78	RG/RG	RUOTE LAMELLARI	10	29
788.00	MANDRINO CREMAGLIERA 10MM-HEX	788005	78	T.01	FOGLI TELA 230X280 GR. 30	50	085869
788.50	MANDRINO AVVITATORE 6,5MM-HEX	788500	78	T.03	FOGLI TELA 230X280 GR. 40	50	085876
789.00	RACCORDO PER MANDRINO 1/2X20	789002	79	T.04	FOGLI TELA 230X280 GR. 60	50	085883
789.10	VITE M6 SINISTRA PER MANDRINI	789101	79	T.05	FOGLI TELA 230X280 GR. 80	50	085890
789.50	RACCORDO M3/8-M1/2	789507	79	T.06	FOGLI TELA 230X280 GR.100	50	085906
789.60	RACCORDO M3/8-M3/8	789606	79	T.07	FOGLI TELA 230X280 GR.120	50	085913
789.70	RACCORDO M1/2-F3/8	789705	79	T.08	FOGLI TELA 230X280 GR.150	50	085920
790.00	CHIAVE PER MANDRINO 10MM B&D	790008	79	T.09	FOGLI TELA 230X280 GR.180	50	085937
791.00	CHIAVE PER MANDRINO 13MM B&D	791005	79	T.10	FOGLI TELA 230X280 GR.220	50	085944
792.00	CHIAVE PER MANDRINO 13MM	792002	79	T.11	FOGLI TELA 230X280 GR.240	50	085951
793.00	CHIAVE PER MANDRINO 16MM	793009	79	T.12	FOGLI TELA 230X280 GR.320	50	085968
794.00	CHIAVE UNIVERSALE PER MANDRINI	794006	79	T.13	FOGLI TELA 230X280 GR.400	50	085975
800.00	UTENSILE CONICO HSS 3/14MM	800004	11	WSC.001	FOGLI CARTA IMPERM.LE GR.100	100	085982
805.00	UTENSILE CONICO HSS 6/20MM	805009	11	WSC.002	FOGLI CARTA IMPERM.LE GR.120	100	085999
810.00	UTENSILE CONICO HSS 8/30MM	810003	11	WSC.003	FOGLI CARTA IMPERM.LE GR.150	100	086002
820.00	UTENSILE CONICO HSS 20/40MM	820002	11	WSC.004	FOGLI CARTA IMPERM.LE GR.180	100	086019
825.00	UTENSILE CONICO HSS 20/50MM	825007	11	WSC.005	FOGLI CARTA IMPERM.LE GR.220	100	086026
825.50	FRESA A GRADINI HSS 4/12MM	825502	11	WSC.006	FOGLI CARTA IMPERM.LE GR.240	100	086033
826.00	FRESA A GRADINI HSS 4/20MM	826004	11	WSC.007	FOGLI CARTA IMPERM.LE GR.280	100	086040
828.00	FRESA A GRADINI HSS 4/30MM	828008	11	WSC.008	FOGLI CARTA IMPERM.LE GR.320	100	086057
829.00	FRESA A GRADINI HSS 3,5/40MM	829005	11	WSC.009	FOGLI CARTA IMPERM.LE GR.360	100	086064

INDICE NUMERICO: ARTICOLI, QUANTITÀ E CODICI A BARRE

Anteporre al codice EAN il prefisso 8011017

ref.	descrizione	☐	ean	pag.	ref.	descrizione	☐	ean	pag.
WSC.010	FOGLI CARTA IMPERM.LE GR.400	100	086071	22	WSC.012	FOGLI CARTA IMPERM.LE GR.600	100	086095	22
WSC.011	FOGLI CARTA IMPERM.LE GR.500	100	086088	22					
M.1010	2 FRESE ACCIAIO SFERA 1,4MM	5	090009	94	M.4155	SPAZZOLA NYLON PENNELLO 5MM	5	090887	102
M.1020	2 FRESE ACCIAIO SFERA 2,3MM	5	090016	94	M.4160	SPAZZOLA NYLON TAZZA 12MM	5	090894	102
M.1030	FRESA ACCIAIO SFERA 4,0MM	5	090092	94	M.4165	SPAZZOLA NYLON CIRCOLARE 21MM	5	090900	102
M.1050	FRESA ACCIAIO SFERA 6,0MM	5	090108	94	M.4170	3 SPAZZOLE NYLON ASSORTITE	5	090917	102
M.1065	FRESA ACCIAIO OVALE 7,8MM	5	092928	94	M.4305	TAMPONE SILICONE DISCO 12MM	5	090924	103
M.1070	2 FRESE ACCIAIO CILIND. 1,4MM	5	090023	94	M.4310	TAMPONE SILICONE LENTICOL.12MM	5	090931	103
M.1080	2 FRESE ACCIAIO CILIND. 2,3MM	5	090030	94	M.4505	PUNTA IN GOMMA BLU FIAMMA 6MM	5	090948	103
M.1100	FRESA ACCIAIO CILINDRICA 6,0MM	5	090115	94	M.4510	PUNTA IN GOMMA BLU OGIVA 5MM	5	090955	103
M.1105	FRESA ACCIAIO CILINDRICA 7,8MM	5	092935	94	M.4515	PUNTA IN GOMMA BLU CILIND. 6MM	5	090962	103
M.1120	2 FRESE ACCIAIO CONO RO. 1,4MM	5	090047	94	M.4595	2 DISCHI GOMMA MARRONE 22X3MM	5	090979	103
M.1130	2 FRESE ACCIAIO CONO RO. 2,3MM	5	090054	94	M.4605	DISCO FELTRO CONO 11MM	5	090986	104
M.1140	FRESA ACCIAIO CONO ROV. 4,0MM	5	090122	94	M.4610	DISCO FELTRO CONO ROV.TO 14MM	5	090993	104
M.1170	2 FRESE ACCIAIO FIAMMA 2,3MM	5	090061	94	M.4615	DISCO FELTRO RUOTA 22MM	5	091006	104
M.1190	FRESA ACCIAIO CON.FIAMMA 4,0MM	5	090139	94	M.4680	KIT 3 FELTRI + ALBERINO +PASTA	5	091013	104
M.1240	FRESA ACCIAIO CONICA 6,0MM	5	090146	94	M.4810	DISCO COTONE MORBIDO 24MM	5	091020	104
M.1270	2 FRESE ACCIAIO PUNTA 2,3MM	5	090078	94	M.4820	DISCO FELTRO MORBIDO 21MM	5	091037	104
M.1310	FRESA ACCIAIO PUNTA 6,0MM	5	090153	94	M.4830	DISCO CAMOSCIO 21MM	5	091044	104
M.1340	2 FRESE ACCIAIO RUOTA 2,3MM	5	090085	94	M.4840	DISCO LAMELLE COTONE 21MM	5	091051	104
M.1370	FRESA ACCIAIO RUOTA 6,0MM	5	090160	94	M.4850	DISCO SCOTCH FABRIC 22MM	5	091068	104
M.1375	FRESA ACCIAIO RUOTA 9,5MM	5	092942	94	M.4905	PASTA PRE-LUCIDATURA ROSA UNIV	5	091075	104
M.1510	FRESA CARBURO SFERA 1,8MM	5	090177	95	M.4910	PASTA BIANCA LUCIDATURA FINALE	5	091082	104
M.1520	FRESA CARBURO SFERA 3MM	5	090184	95	M.4915	PASTA ABRASIVA ROSSA	5	091099	104
M.1540	FRESA CARBURO CILINDRICA 1,8MM	5	090191	95	M.5010	5 DISCHI TAGLIO 22X0,25MM SLIM	5	091105	105
M.1550	FRESA CARBURO CILINDRICA 3MM	5	090207	95	M.5030	10 DISCHI DA TAGLIO 22X0,6MM	5	091112	105
M.1560	FRESA CARBURO CONICA 1,8MM	5	090214	95	M.5035	50 DISCHI DA TAGLIO 22X0,6MM	5	091129	105
M.1570	FRESA CARBURO CONICA 3MM	5	090221	95	M.5040	10 DISCHI TAGLIO 22X1MM RINF.	5	093680	105
M.1580	FRESA CARBURO FIAMMA 3MM	5	090238	95	M.5045	30 DISCHI TAGLIO 22X1MM RINF.	5	093697	105
M.1710	FRESA HSS PROF. CONVESSI 3MM	2	090320	95	M.5050	5 DISCHI TAGLIO 40X1MM RINF.	5	091136	105
M.1720	FRESA HSS PROF. CONCAVI 4MM	2	090337	95	M.5130	2 DISCHI SGROSSATURA 32X2,2MM	5	091143	105
M.1750	FRESA HSS SCAN. DIRITTE 3MM	2	090344	95	M.5405	MINI LAMA ACCIAIO 13MM	5	091150	106
M.1770	FRESA HSS SCANLATURE V 6,4MM	2	090351	95	M.5410	MINI LAMA ACCIAIO 19MM	5	091167	106
M.1905	PUNTA DIAMANTE SFERA 1,0MM	5	090245	96	M.5415	MINI LAMA ACCIAIO 25MM	5	091174	106
M.1910	PUNTA DIAMANTE SFERA 1,4MM	5	090252	96	M.5710	DISCO DIAMANTATO 22MM	5	091181	106
M.1915	PUNTA DIAMANTE SFERA 1,8MM	5	090269	96	M.5715	DISCO DIAMANTATO 30MM	5	093314	106
M.1925	PUNTA DIAMANTE CILINDRICA 1,5	5	090276	96	M.5720	DISCO DIAMANTATO 40MM	5	093321	106
M.1935	FRESA DIAMANTE CILINDRICA 3,2	5	090283	96	M.5750	DISCO DIAMANTATO SEGMENT. 22MM	5	093338	106
M.1950	PUNTA DIAMANTE FIAMMA 1,6MM	5	090290	96	M.5905	PUNTA TAGLIO LEGNO 3,2MM	5	093345	106
M.1970	PUNTA DIAMANTE PUNTA 2,8MM	5	090306	96	M.5910	PUNTA TAGLIO CARTONGESSO 3,2MM	5	093352	106
M.1980	FRESA DIAMANTE DISCO 5MM	5	090313	96	M.5915	PUNTA TAGLIO PIASTRELLE 3,2MM	5	093369	106
M.2010	2 MOLE RUBINO CILIND. 3X8MM	5	090368	97	M.6005	2 PUNTE HSS 0,5MM	5	091198	107
M.2025	2 MOLE RUBINO CILIND. 5X10MM	5	090375	97	M.6006	2 PUNTE HSS 0,6MM	5	091204	107
M.2040	2 MOLE RUBINO CILIND. 8X10MM	5	090382	97	M.6008	2 PUNTE HSS 0,8MM	5	091211	107
M.2055	2 MOLE RUBINO CILIND. 10X12MM	5	090399	97	M.6010	2 PUNTE HSS 1,0MM	5	091228	107
M.2070	2 MOLE RUBINO CILIND.12X15MM	5	090405	97	M.6012	2 PUNTE HSS 1,2MM	5	091235	107
M.2085	2 MOLE RUBINO CONICA 3X8MM	5	090412	97	M.6015	2 PUNTE HSS 1,5MM	5	091242	107
M.2100	2 MOLE RUBINO CONICA 5X10MM	5	090429	97	M.6020	2 PUNTE HSS 2,0MM	5	091259	107
M.2115	2 MOLE RUBINO CONICA 8X12MM	5	090436	97	M.6024	2 PUNTE HSS 2,4MM	5	091266	107
M.2130	2 MOLE RUBINO OGIVA 6X10MM	5	090443	97	M.6030	2 PUNTE HSS 3,0MM	5	091273	107
M.2145	2 MOLE RUBINO OGIVA 10X20MM	5	090450	97	M.6100	KIT 20 PUNTE HSS 0,3/1,6MM	2	091396	107
M.2160	2 MOLE RUBINO SFERA 6MM	5	090467	97	M.6206	PUNTA HSS RINFORZATA 0,6MM	5	091280	107
M.2175	2 MOLE RUBINO SFERA 10MM	5	090474	97	M.6208	PUNTA HSS RINFORZATA 0,8MM	5	091297	107
M.2190	2 MOLE RUBINO CIL.CON. 6X12MM	5	090481	97	M.6210	PUNTA HSS RINFORZATA 1,0MM	5	091303	107
M.2205	2 MOLE RUBINO CIL.CON. 8X15MM	5	090498	97	M.6212	PUNTA HSS RINFORZATA 1,2MM	5	091310	107
M.2220	2 MOLE RUBINO CIL.CON. 10X20MM	5	090504	97	M.6215	PUNTA HSS RINFORZATA 1,5MM	5	091327	107
M.2235	2 MOLE RUBINO CON. ROV. 8X6MM	5	090511	97	M.6220	PUNTA HSS RINFORZATA 2,0MM	5	091334	107
M.2410	2 MOLE CARBURO CON. ARR.3X8MM	5	090528	98	M.8010	KIT 5 PINZE + GHIERA	2	093017	108
M.2420	2 MOLE CARBURO CON. ARR.5X10MM	5	090535	98	M.8020	KIT 4 PINZE + GHIERA DREMEL	2	093024	108
M.2435	2 MOLE CARBURO SFERA 4MM	5	090542	98	M.8100	ALBERINO A VITE	5	091358	108
M.2450	2 MOLE CARBURO CON. ROV. 8X6MM	5	090559	98	M.8110	ALBERINO A VITE RINFORZATO	5	091365	108
M.2465	2 MOLE CARBURO SEMISF. 6X10MM	5	090566	98	M.8120	ALBERINO A PIRAMIDE	5	091372	108
M.2480	2 MOLE CARBURO FIAMMA 5X10MM	5	090573	98	M.8210	KIT 10 ACCESSORI PER INCISIONI	2	093031	109
M.2510	2 MOLE RUBINO LENTICOLARE 22MM	5	090580	98	M.8230	KIT 10 ACCESSORI SMERIGLIATURA	2	093048	109
M.2520	2 MOLE CARBURO LENTICOLARE 22	5	090597	98	M.8250	KIT 9 ACCESSORI LUCIDATURA	2	093055	109
M.2610	2 MOLE RUBINO RUOTINA 22MM	5	090603	98	M.8270	KIT 58 ACCESSORI PER TAGLIO	2	093062	109
M.2620	2 MOLE CARBURO RUOTINA 22MM	5	090610	98	M.8305	CAVI PROLUNGA 5M	1	091402	108
M.2630	2 MOLE ABR. BIANCO RUOTINA 22	5	090627	98	M.8500	MINI ALBERO FLESSIBILE 80CM	1	091426	110
M.2640	2 MOLE ABR. MARRONE RUOTINA 22	5	090634	98	M.8550	MANDRINO AUTOSERRANTE 0,4/3,2	1	091389	110
M.2710	2 MOLE RUBINO AF.CATENE 4,0X19	5	090641	99	M.8560	MANDRINO AUTO.0,4/3,2MM DREMEL	1	093376	110
M.2715	2 MOLE RUBINO AF.CATENE 4,8X19	5	090658	99	M.8580	MANDRINO CREMAGLIERA 0,5/6MM	1	093598	110
M.2720	2 MOLE RUBINO AF.CATENE 5,6X21	5	090665	99	M.8600	SUPPORTO ORIENTABILE 43+33MM	1	091433	111
M.2910	RAVVIVAMOLE D.GRANA 16X12X65MM	5	090672	99	M.8710	SUPPORTO PER MINI TRAPANI	1	093666	111
M.3020	RUOTA LAMELLARE 20X05MM GR. 80	5	090689	100	M.8750	MINI MORSA DA BANCO 50MM	1	093383	111
M.3030	RUOTA LAMELLARE 30X10MM GR. 80	5	090696	100	M.8775	KIT SVITA E AVVITA 45 PCS	1	093574	111
M.3210	PLATORELLO E 6 DISCHI ABRASIVI	5	090702	100	M.8790	KIT CUTTER PRECISIONE 18 PCS	1	093581	112
M.3220	10 DISCHI ADESIVI 20MM GR. 100	5	090719	100	M.8800	PIROGRAFO 30W + 2 PUNTE + SUPP	1	093550	112
M.3230	10 DISCHI ADESIVI 20MM GR. 220	5	090726	100	M.8815	PISTOLA TERMOCOLLANTE 30W-7MM	1	093703	113
M.3610	SMERIGLIATORE ESP.NE 13X13MM	5	090733	100	M.8820	PISTOLA TERMOCOLLANTE 20W-7MM	1	093529	113
M.3620	12 NASTRI ABRASIVI 13MM GR. 60	5	090740	100	M.8822	12 STICK COLLA 7X100MM	10	600000	113
M.3630	12 NASTRI ABRASIVI 13MM GR.120	5	090757	100	M.8845	PISTOLA TERMOCOLLANTE 60W-11MM	1	093710	113
M.3640	SMERIGLIATORE ESP.NE 9,5X13MM	5	092959	101	M.8857	12 STICK COLLA 11X100MM	10	600208	113
M.3650	12 NASTRI ABRA.VI 9,5MM GR. 60	5	092966	101	M.9000	TRASFORMATORE UNA VELOCITA'	1	091440	114
M.3660	12 NASTRI ABRA.VI 9,5MM GR.120	5	092973	101	M.9100	MINI TRAPANO 30W	1	091464	116
M.3670	SMERIGLIATORE ESP.NE 6,3X13MM	5	092980	101	M.9150	KIT MINI TRAPANO 30W	1	091471	116
M.3680	12 NASTRI ABRA.VI 6,3MM GR. 60	5	092997	101	M.9200	PENNA PER INCISIONI 6W	1	091488	114
M.3690	12 NASTRI ABRA.VI 6,3MM GR.120	5	093000	101	M.9220	PENNA PER INCISIONI 6W + TRASF	1	093628	115
M.4005	SPAZZOLA ACCIAIO PENNELLO 5MM	5	090764	102	M.9250	KIT PER INCISIONI 6W	1	091495	115
M.4010	SPAZZOLA ACCIAIO TAZZA 12MM	5	090771	102	M.9300	MINI TRAPANO PRECISIONE 60W	1	093604	117
M.4015	SPAZZOLA ACCIAIO CIRCOLARE 21	5	090788	102	M.9350	KIT MINI TRAPANO PRECIS. 60W	1	093611	117
M.4020	3 SPAZZOLE ACCIAIO ASSORTITE	5	090795	102	M.9500	MINI TRAPANO 130W	1	093116	118
M.4055	SPAZZOLA OTTONE PENNELLO 5MM	5	090801	102	M.9550	KIT MINI TRAPANO 130W	1	093123	118
M.4060	SPAZZOLA OTTONE TAZZA 12MM	5	090818	102	M.9600	MINI TRAPANO 170W LCD	1	093413	119
M.4065	SPAZZOLA OTTONE CIRCOLARE 21MM	5	090825	102	M.9650	KIT MINI TRAPANO 170W LCD	1	093420	119
M.4070	3 SPAZZOLE OTTONE ASSORTITE	5	090832	102	M.BOX01	SCATOLA MODULARE PORTA ACC.RI	1	082228	110
M.4105	SPAZZOLA SETOLA PENNELLO 5MM	5	090849	102	ESPO.M3A	ESPO DA BANCO PG MINI 162 PZ	1	093727	120
M.4110	SPAZZOLA SETOLA TAZZA 12MM	5	090856	102	ESPO.M3B	ESPO DA BANCO PG MINI 141 PZ	1	093734	120
M.4115	SPAZZOLA SETOLA CIRCOLARE 21MM	5	090863	102	ESPO.M3C	ESPO A PARETE PG MINI 709 PZ	1	093741	121
M.4120	3 SPAZZOLE SETOLA ASSORTITE	5	090870	102					

CONDIZIONI GENERALI DI VENDITA

P.G. SRL DECLINA OGNI RESPONSABILITÀ PER DANNI PROVOCATI DAI PROPRI PRODOTTI IMPUTABILI AD UN ERRATO E/O INCAUTO E/O IMPROPRIO UTILIZZO DEGLI STESSI

Gli ordini sono assunti esclusivamente alle seguenti condizioni:

- Il trasporto viene effettuato tramite il mezzo da noi ritenuto più idoneo
- I termini di consegna non sono mai impegnativi e possono non essere rispettati, si escludono perciò risarcimenti per ritardi e/o consegne parziali e/o mancate consegne
- Reclami per contestazioni o differenze riscontrate devono pervenire entro otto giorni dalla data di ricezione della merce
- I pagamenti devono essere effettuati alle condizioni prestabilite
- Non si accettano sconti o arrotondamenti se non concordati preventivamente
- Per ritardato pagamento decorrono gli interessi di mora ed eventuali spese accessorie
- Si riconosce l'esclusiva competenza del Foro di Bologna per ogni controversia, anche se il contratto è stato stipulato in altra sede

È VIETATO OGNI UTILIZZO E/O RIPRODUZIONE ANCHE PARZIALE DEL TESTO, DEI DISEGNI E DELLE FOTOGRAFIE SENZA PREVIA AUTORIZZAZIONE DA PARTE DI P.G. SRL

LE FOTOGRAFIE, LE DESCRIZIONI, I DISEGNI E LE TABELLE SONO PURAMENTE INDICATIVE, P.G. SRL SI RISERVA IL DIRITTO DI EFFETTUARE MODIFICHE DEI PRODOTTI SENZA OBBLIGO DI PREAVVISO



P.G. Srl
Via Piretti, 12/A
40012 Calderara di Reno (BO) Italia
Tel. +39.051.727.102 - Fax +39.051.728.075
info@pgprofessional.it - www.pgprofessional.it
info@pgmini.it - www.pgmini.it